



ACVATIX™

## Electromotoric actuators for valves

**SAX..**

with a 20 mm stroke

- 
- **SAX31..** Operating voltage AC 230 V, 3-position control signal
  - **SAX61..** Operating voltage AC/DC 24 V, control signal DC 0...10 V, 4...20 mA
  - **SAX81..** Operating voltage AC/DC 24 V, 3-position control signal
  - **SAX61..** Position feedback, override control, choice of flow characteristic
  - For direct mounting on valves; no adjustments required
  - Manual adjuster, position indicator and status indication per LED
  - Optional functions with auxiliary switches, potentiometer, function module, stem heating element

### Use

---

For the operation of Siemens 2-port and 3-port valves, types V..F21.., V..F22.., V..F31.., V..F32.., V..F40.., V..F41.., V..G41.., V..F42.., VVF52.. and V..F53.. with 20 mm stroke as control and safety shut-off valves in heating, ventilation and air conditioning systems.

## Type summary

Product no.	Stock no.	Stroke	Pos. force	Operating voltage	Positioning signal	Spr. ret. time	Pos. time	LED	Manual adjuster	Extra functions			
<b>SAX31.00</b>	S55150-A105	20 mm	800 N	AC 230 V	3-Punkt	-	120 s	-	Push and fix	-			
<b>SAX31.03</b>	S55150-A106			AC/DC 24 V	DC 0...10 V DC 4...20 mA 0...1000 Ω		3-Punkt	30 s		✓	Position feedback, forced control, change of characteristic		
<b>SAX61.03</b>	S55150-A100									-	120 s	-	-
<b>SAX61.03U</b>	S55150-A100-A100												
<b>SAX81.00</b>	S55150-A102												
<b>SAX81.00U</b>	S55150-A102-A100	3-Punkt	30 s	-	-								
<b>SAX81.03</b>	S55150-A103												
<b>SAX81.03U</b>	S55150-A103-A100												

## Electrical accessories

Product no.	Auxiliary switch ASC10.51	Potentiometer ASZ7.5/.. <sup>1)</sup>	Function module AZX61.1	Stem heating element ASZ6.6
Stock no.	S55845-Z103	S55845-Z104 (ASZ7.5/135) S55845-Z105 (ASZ7.5/200) S55845-Z106 (ASZ7.5/1000)	S55845-Z107	S55845-Z108
		Max. 2		Max. 1
<b>SAX31..</b>	Max. 2	Max. 1	-	Max. 1
<b>SAX61..</b>	Max. 2	-	Max. 1 AZX61.1	
<b>SAX81..</b>		Max. 1	-	

<sup>1)</sup> Available with 135 Ω, 200 Ω or 1000 Ω

## Mechanical Accessory

Weather shield ASK39.1

## Ordering



### Example

Product no.	Stock no.	Description	Quantity
SAX81.03	S55150-A103	Actuator	1
ASZ7.5/1000	S55845-Z106	Potentiometer	1

### Delivery

Actuators, valves and accessories are supplied in individual packs.

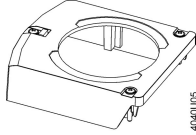
### Spare parts

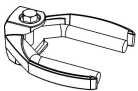
Product number / Stock number	Description	Image
8000060843	Housing cover	
	Screw (valve stem coupling)	
	U-bracket	

## Product documentation

Detailed Informations about the New Generation actuators can be found in the Basic documentation "Electromotoric actuators SAX.." (CE1P4040\_01en).

## Combinations

Type reference		DN	PN class	$K_{vs}$ [m <sup>3</sup> /h]	Data sheet
<b>2-port valves VV.. (control or safety shutoff valves)</b>					
VVF21..	flange	25...80	6	1.9...100	N4310
VVF22..	flange	25...80	6	2.5...100	N4401
VVF31..	flange	15...80	10	2.5...100	N4320
VVF32..	flange	15...80	10	1.6...100	N4402
VVF40..	flange	15...80	16	1.9...100	N4330
VVF41..	flange	50		19 / 31	N4340
VVF42..	flange	15...80		1.6...100	N4403
VVF42..K	flange	50...80		40...100	
VVG41..	thread	15...50		0.63...40	N4363
VVF52..	flange	15...40	25	0.16...25	N4373
VVF53..	flange	15...50		0.16...40	N4405
<b>3-port valves VX.. (control valves for "mixing" and "diverting" functions)</b>					
VXF21..	flange	25...80	6	1.9...100	N4410
VXF22..	flange	25...80	6	2.5...100	N4401
VXF31..	flange	15...80	10	2.5...100	N4420
VXF32..	flange	15...80	10	1.6...100	N4402
VXF40..	flange	15...80	16	1.9...100	N4430
VXF41..	flange	15...50		1.9...31	N4440
VXF42..	flange	15...80		1.6...100	N4403
VXG41..	thread	15...50		1.6...40	N4463
VXF53..	flange	15...50	25	1.6...40	N4405

## Notes

**Engineering**  
SAX31.. and SAX81..

3-position actuators must have their own specific controller, refer to "Connection Diagrams" (page 7).

SAX61..

Up to 10 actuators can drive in parallel on a controller output with a rating of 1 mA. Modulating actuators have an input impedance of 100 kΩ.

## Mounting

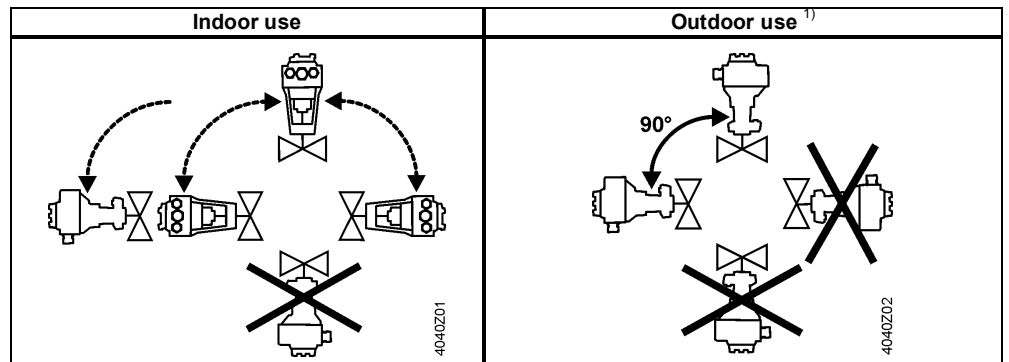

<sup>1)</sup> Only in connection with weather shield ASK39.1

## Maintenance

The actuators are maintenance-free.

## Warranty

The engineering data specified in chapter "

Combinations" (page 3) are only guaranteed in connection with the Siemens valves listed.

**Note**

**When using the actuators in connection with valves of other manufacture, correct functioning must be ensured by the user, and Siemens will assume no responsibility.**

## Technical Data

		SAX..
<b>Power supply</b>	Operating voltage SAX31.. SAX61.. SAX81..	AC 230 V ±15% AC 24 V ± 20% / DC 24 V + 20% / -15% AC 24 V ±20% / DC 24 V + 20 % / -15%
	Frequency	45...65Hz
	Fusing ac. DIN 57 100 part 430 (supply lines)	6 A... 10 A slow
	Power consumption at 50 Hz	
	SAX31.00 Stem retracts / extends SAX31.03 Stem retracts / extends SAX61.03.. Stem retracts / extends SAX81.00.. Stem retracts / extends SAX81.03.. Stem retracts / extends	3.5 VA / 2 W 6 VA / 3.5 W 8 VA / 3.75 W 3.5 VA / 2.25 W 5 VA / 3.75 W
<b>Function data</b>	Positioning times (with the specified nominal stroke) The positioning time can vary, depending on the type of valve -> refer chapter "Type summary" (page 2) SAX31.00, SAX81.00.. SAX31.03, SAX61.03.., SAX81.03..	120 s 30 s
	Positioning force Nominal stroke Working stroke area the actuator is able to calibrate Permissible medium temperature (valve fitted)	800 N 20 mm 6 .. 24 mm -25°...130 °C
<b>Signal inputs</b>	Positioning signal "Y" SAX31..., SAX81.. SAX31.. Voltage SAX81.. Voltage SAX61.. (DC 0...10 V) Current draw Input impedance SAX61.. (DC 4...20 mA) Current draw Input impedance	3-position AC 230 V ±15% AC 24 V ± 20 % / DC 24 V + 20 % / -15% ≤ 0.1 mA ≥100 kΩ DC 4...20 mA ± 1% ≤500 Ω
	<b>Parallel operation</b>	SAX61.. ≤ 10 (depending on controller output)
<b>Forced control</b>	Positioning signal "Z" SAX61.. R = 0...1000 Ω Z connected to G Z connected to G0 Voltage Current draw	R = 0...1000 Ω, G, G0 Stroke proportional to R Max. stroke 100% <sup>1)</sup> Min. stroke 0% <sup>1)</sup> Max. AC 24 V ± 20% Max. DC 24 V + 20% / -15% ≤ 0.1 mA
<b>Position feedback</b>	Position feedback U SAX61.. Load impedance Load	DC 0...10 V ± 1% >10 kΩ res. Max. 1 mA
<b>Connecting cable</b>	Wire cross-sectional areas	0.13...1.5 mm <sup>2</sup> , AWG 24...16 <sup>2)</sup>
	Cable entries SAX.. SAX..U	EU: 2 entries Ø 20.5 mm (for M20) 1 entry Ø 25.5 mm (for M25) US: 3 entries Ø 21.5 mm for ½" tube connection
<b>Degree of protection</b>	Housing from vertical to horizontal	IP54 as per EN 60529 <sup>3)</sup>
	Insulation class Actuators SAX31.. AC 230 V Actuators SAX61.. AC / DC 24 V Actuators SAX81.. AC / DC 24 V	As per EN 60730 II III III
<b>Environmental conditions</b>	Operation Climatic conditions Mounting location Temperature Genera Humidity (noncondensing)	IEC 60721-3-3 Class 3K5 Indoors (weather-protected) -5...55 °C 5...95% r.h.
	Transport Climatic conditions Temperature Humidity	IEC 60721-3-2 Class 2K3 -25...70 °C <95% r.h.
	Storage Climatic conditions Temperature Humidity	IEC 60721-3-1 Class 1K3 -15...55 °C 5...95% r.h.
	Max. media temperatur when mounted on valve	130 °C
<b>Standards</b>	CE conformity As per EMC directive Immunity Emmissions	2004/108/EC EN 61000-6-2:[2005] Industrial <sup>4)</sup> EN 61000-6-3:[2007] Residential
	Electrical safety	EN 60730-1
	Low-voltage directive AC 230 V	2006/95/EC
	C-tick	N 474
	UL conformity AC 230 V AC/DC 24 V	- UL 873

		SAX..
<b>Environmental compatibility</b>		ISO 14001 (environment) ISO 9001 (quality) SN 36350 (environment-compatible products) RL 2002/95/EG (RoHS)
<b>Dimensions</b>		See "Dimensions" (page 8)
<b>Accessories</b>	Potentiometer ASZ7.5/135	0...135 Ω ± 5%
	Voltage	DC 10 V
	Current rating	<4 mA
	Potentiometer ASZ7.5/200	0...200 Ω ± 5%
	Voltage	DC 10 V
Current rating	<4 mA	
Potentiometer ASZ7.5/1000	0...1000 Ω ± 5%	
Voltage	DC 10 V	
Current rating	<4 mA	
Auxiliary switch ASC10.51	Switching capacity	AC 24...230 V, 6 A res., 2A ind.
Stem heating element ASZ6.6	Power supply	AC/DV 24 V, ± 20%
	Power consumption	40 VA / 30 W
	Inrush current (cold)	13 A

<sup>1)</sup> Observe acting direction of DIL switches

<sup>2)</sup> AWG = American wire gauge

<sup>3)</sup> Also with weather shield ASK39.1

<sup>4)</sup> Transformer 160 VA (e.g. Siemens 4AM 3842-4TN00-0EA0) for actuators operating on AC 24 V

## Connection Diagrams

### Internal Diagrams

SAX31..

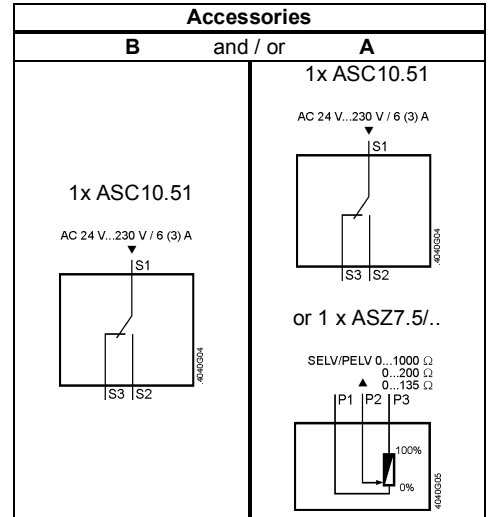
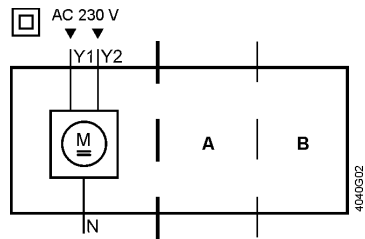

SAX61..

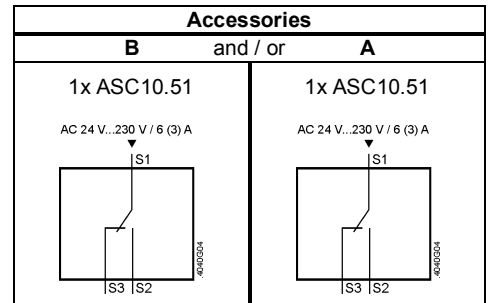
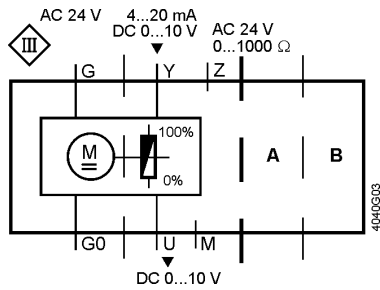

SAX81..

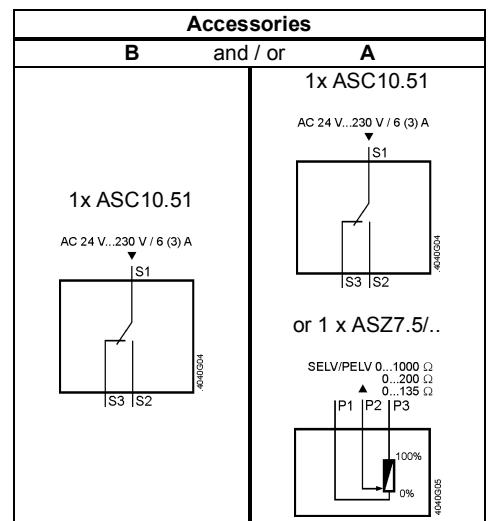
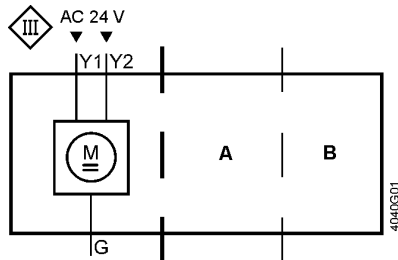

### Connection terminals

SAX31..

AC 230 V, 3-position

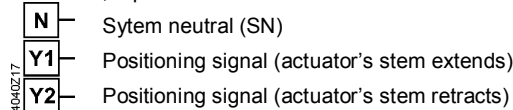

SAX61..

AC/DC 24 V, DC 0...10 V / 4...20 mA / 0...1000 Ω

- G0** — Sytem neutral (SN)
- G** — Sytem potential (SP)
- Y** — Positioning signal for DC 0...10 V / 4...20 mA
- M** — Measuring neutral
- U** — Position feedback DC 0...10 V - (reference potential is M measuring neutral)
- Z** — Positioning signal forced control

SAX81..

AC/DC 24 V, 3-position

- G** — Sytem potential (SP)
- Y1** — Positioning signal (actuator's stem extends)
- Y2** — Positioning signal (actuator's stem retracts)

**Connection Diagrams**  
SAX31..

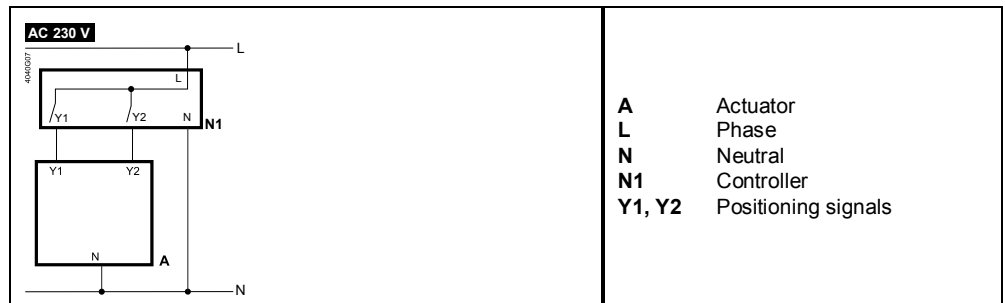

SAX61..

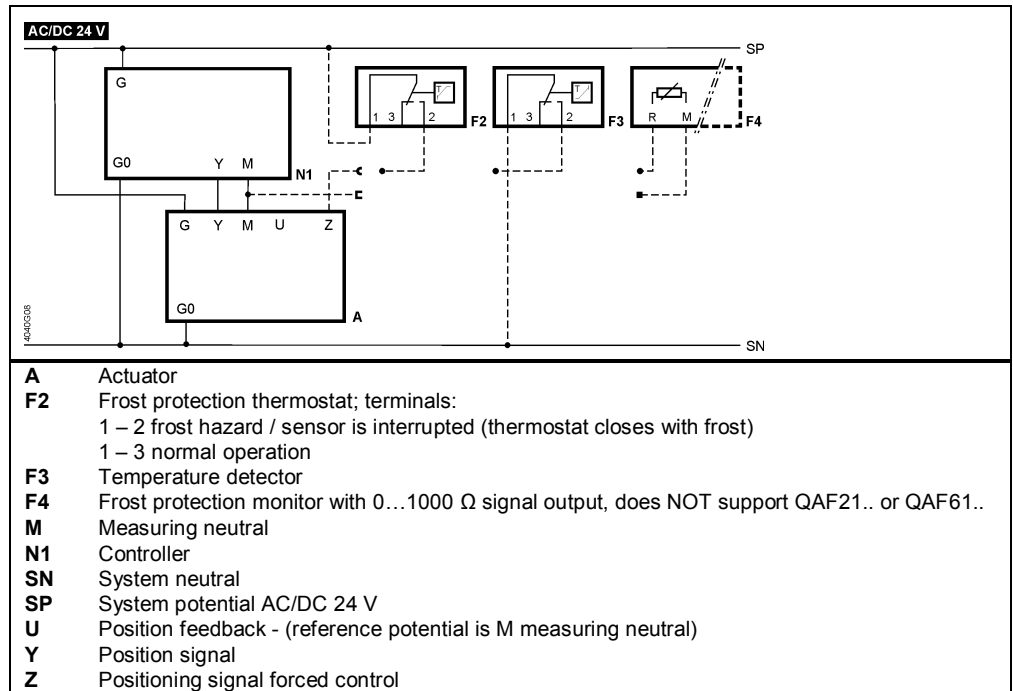

SAX81..

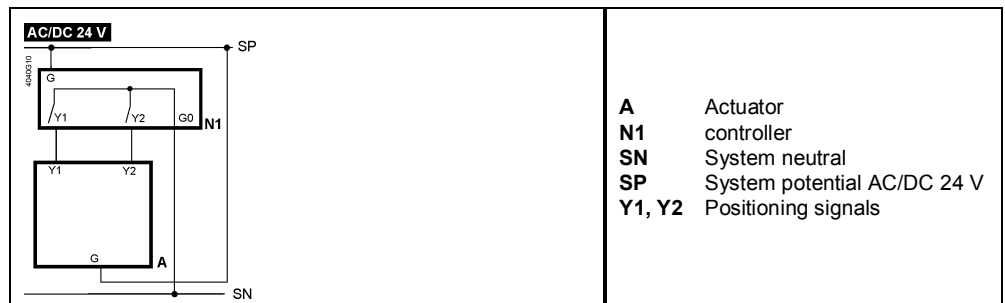



## Dimensions

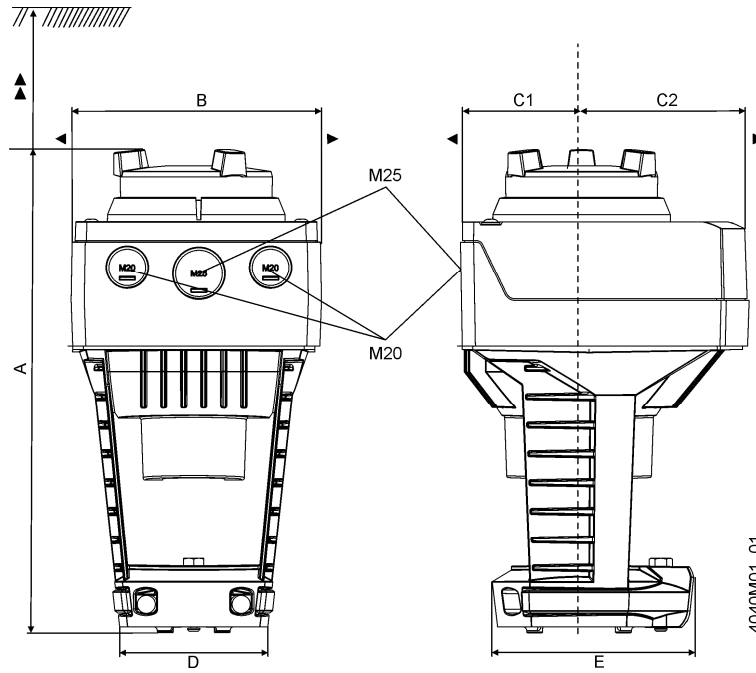

Product no.	A	B	C	C1	C2	D	E	▶	▶▶	kg
SAX..(U <sup>1)</sup> )	242	124	150	68	82	80	100	100	200	1,850
With ASK39.1	+25	154	300	200	100	-	-	-	-	2,080

Dimensions in mm

<sup>1)</sup> SAX..U: For 1/2" tube connections (21.5 mm dia.)

## Revision numbers

Product no.	Valid from rev. no.
SAX31.00	..G
SAX31.03	..G
SAX61.03..	..G
SAX81.00..	..G
SAX81.03..	..G