



RDG1...



RDG1...T



RDG100T/H

Room thermostats with LCD for wall mounting

RDG1...

for fan coil unit applications

for universal applications

for use with compressors in dx type equipment

- RDG100...: Operating voltage AC 230 V, On/Off, 3-pos. or PWM control outputs
- RDG110: Operating voltage AC 230 V, On/Off relay (SPDT) outputs
- RDG160T: Operating voltage AC 24 V, DC 0...10 V or On/Off control outputs, DC 0...10 V or 1- / 3- speed
- Operating modes: Comfort, Economy and Protection
- Automatic or manual fan speed
- Output for 1-speed, 3-speed or ECM fan DC 0...10 V (RDG160T)
- 3 multifunctional inputs for keycard contact, external sensor, etc.
- Automatic or manual heating / cooling changeover
- Adjustable commissioning and control parameters
- Minimum and maximum setpoint limitation
- Backlit display

Additional features of RDG100T, RDG160T, RDG100T/H:

- Infrared remote control receiver
- Auto Timer mode with 8 programmable timers
- Auto timer can be disabled via P02
- Auto timer can be disabled via DIP switches (only RDG160T)
- Landscape design (only RDG100T/H)
- Selectable relay output functions (RDG160T)

The RDG1... room thermostats are designed for use with the following types of system:

Fan coil units via On/Off or modulating control outputs:

- 2-pipe system
- 2-pipe system with electrical heater
- 2-pipe system and radiator / floor heating
- 4-pipe system
- 4-pipe system with electrical heater
- 2-stage heating or cooling system

Chilled / heated ceilings (or radiators) via On/Off or modulating control outputs:

- Chilled / heated ceiling
- Chilled / heated ceiling with electrical heater
- Chilled / heated ceiling and radiator / floor heating
- Chilled / heated ceiling, 2-stage cooling or heating

Heat pumps with dx type equipment:

- 1-stage compressor for heating or cooling
- 1-stage compressor for heating or cooling with electrical heater
- 1-stage compressor for heating or cooling and radiator / floor heating
- 1-stage compressor for heating and cooling
- 1-stage compressor for heating and cooling with reversing valve
- 2-stage compressor for heating or cooling

Functions

- Maintenance of room temperature via built-in temperature sensor or external room temperature / return air temperature sensor
- Automatic or manual changeover between heating and cooling mode
- Selection of applications via DIP switches
- Selection of operating mode via the operating mode button on the thermostat
- 1-speed, 3-speed or DC...10 V fan control (automatic or manual)
- Display of current room temperature or setpoint in °C and/or °F
- Minimum and maximum setpoint limitation
- Button lock (automatic or manual)
- 1 digital input, freely selectable for:
 - Operating mode switchover contact (keycard)
 - Automatic heating / cooling changeover contact
 - Electric heater enable
 - Dewpoint sensor
 - Fault input
- 2 multifunctional inputs, freely selectable for:
 - Operating mode switchover contact (keycard)
 - Automatic heating / cooling changeover sensor
 - External room temperature or return air temperature
 - Dewpoint sensor
 - Electric heater enable
 - Fault input
 - Supply air temperature sensor (RDG160T)
- Advanced fan control function, i.e. fan kick, fan start, selectable fan operation (enable, disable or depending on heating or cooling mode)
- Purge function together with 2-port valve in a 2-pipe changeover system
- Reminder to clean filters
- Floor heating temperature limit
- Minimum and maximum supply air temperature limitation (RDG160T)
- Reloading factory settings for commissioning and control parameters

- 7-day time program: 8 programmable timers to switch over between Comfort and Economy mode (RDG100T, RDG160T, RDG100T/H)
- Infrared remote control (RDG100T, RDG160T, RDG100T/H)
- Selectable relay function (RDG160T)
 - for switching OFF external equipment OFF during PROTECTION mode
 - for switching ON external equipment (e.g. pump) during H/C demand
 - output heating / cooling sequence

Applications

The room thermostats support the following applications, which can be configured via DIP switches at the rear of the unit. Depending on the thermostat type, On/Off or modulating control outputs are available.

Applications, DIP setting, Control outputs		
<ul style="list-style-type: none"> • 2-pipe fan coil unit <p>Using RDG100..., RDG110, RDG160T</p>	<ul style="list-style-type: none"> • 2-pipe fan coil unit and electric heater <p>Using RDG100..., RDG110, RDG160T</p>	<ul style="list-style-type: none"> • 2-pipe fan coil unit and radiator / floor heating <p>Using RDG100..., RDG110, RDG160T</p>
<ul style="list-style-type: none"> • 2-pipe / 2-stage fan coil unit <p>Using RDG100..., RDG110, RDG160T</p>	<ul style="list-style-type: none"> • 4-pipe fan coil unit <p>Using RDG100..., RDG110, RDG160T</p>	<ul style="list-style-type: none"> • 4-pipe fan coil unit and electric heater <p>Using RDG100...</p>

Product no.	Control outputs	Fan
RDG100	On/Off, PWM, 3-position	3-speed, 1-speed
RDG110	On/Off (SPDT)	3-speed, 1-speed
RDG160T	DC 0...10 V	3-speed, 1-speed
RDG160T	On/Off, DC 0...10 V	DC 0...10 V ECM

Applications, DIP setting, Control outputs

- Chilled / heated ceiling

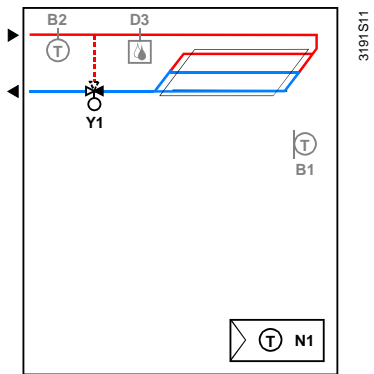

Using RDG100..., RDG110, RDG160T

- Chilled / heated ceiling and electric heater

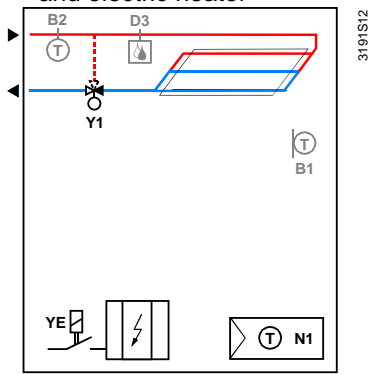

Using RDG100..., RDG110, RDG160T

- Chilled / heated ceiling and radiator / floor heating

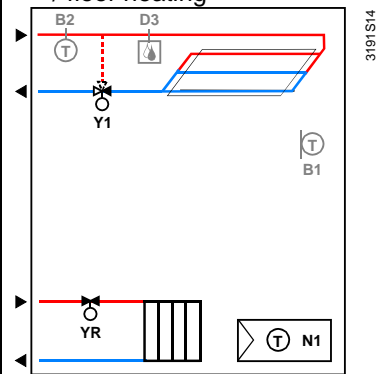

Using RDG100..., RDG110, RDG160T

- 2-stage chilled / heated ceiling

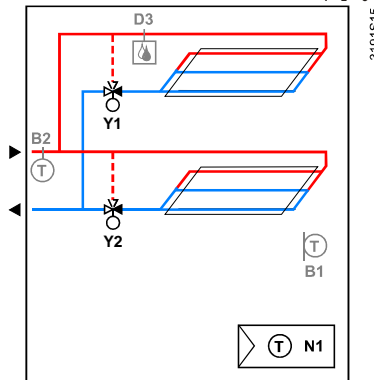

Using RDG100..., RDG110, RDG160T

- Chilled ceiling and radiator

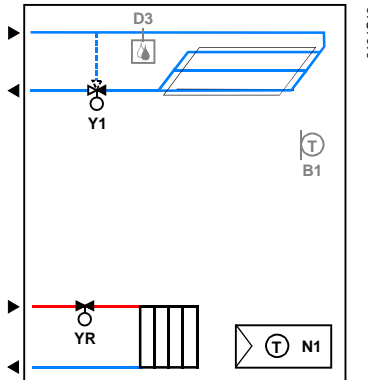

Using RDG100..., RDG110, RDG160T

Product no.	Control outputs
RDG100	On/Off, PWM, 3-position
RDG110	On/Off (SPDT)
RDG160T	On/Off, DC 0...10 V

Applications, DIP setting, Control outputs

<ul style="list-style-type: none"> Heated or cooled with compressors <p>Using RDG110, RDG160T</p>	<ul style="list-style-type: none"> Heated or cooled with compressors with electric heater <p>Using RDG110, RDG160T</p>
<ul style="list-style-type: none"> Heated and cooled with compressors <p>Using RDG110, RDG160T</p>	<ul style="list-style-type: none"> 2-stage heated or cooled with compressors <p>Using RDG110, RDG160T</p>

Product no.	Control outputs	Fan
RDG110	On/Off (SPDT)	Disabled, 3-speed, 1-speed
RDG160T	On/Off, DC 0...10 V	Disabled, DC 0...10 V













- | | | |
|-----|--|---|
| Key | Y1 Heating or heating / cooling valve actuator | M1 1-speed or 3-speed fan |
| | Y2 Cooling valve actuator | B1 Return air temperature sensor or external room temperature sensor (optional) |
| | YE Electric heater | B2 Changeover sensor (optional) |

Type summary













Product no.	Features									
	Operating voltage	Number of control outputs				Time program	Backlit LCD	Infrared receiver ¹⁾	Fan	
		ON/OFF	PWM	3-pos	DC 0..10 V				ECM ²⁾	3-speed
RDG100	AC 230 V	3 ³⁾	2 ³⁾	2 ³⁾			✓			✓
RDG100T	AC 230 V	3 ³⁾	2 ³⁾	2 ³⁾		(✓) ⁵⁾	✓	✓		✓
RDG100T/H	AC 230 V	3 ³⁾	2 ³⁾	2 ³⁾		(✓) ⁵⁾	✓	✓		✓
RDG110	AC 230 V	2 ⁴⁾					✓			✓
RDG160T	AC 24 V				2	(✓) ⁵⁾	✓	✓		✓
		2 ⁶⁾			2 ⁶⁾	(✓) ⁵⁾	✓	✓	✓	

- 1) Infrared remote control must be ordered as a separate item
- 2) ECM fan output DC 0...10 V
- 3) On/Off, PWM or 3-position (triac outputs)
- 4) Relay output (SPDT)
- 5) Can be disabled via P02 (or via DIP switches on RDG160T)
- 6) Either On/Off or DC control signal

Equipment combinations

	Description	Product no.	Data Sheet
	Infrared remote control 	IRA211	3059
	Cable temperature or changeover sensor 	QAH11.1	1840
	Room temperature sensor 	QAA32	1747
	Condensation motion 	QXA2601 / QXA2602 / QXA2603 / QXA2604	3302
On/Off actuators	Electromotoric On/Off valve and actuator (only available in AP, UAE, SA and IN) 	MVI.../MXI...	4867
	Electromotoric On/Off actuator 	SFA21...	4863
	Zone valve actuators (only available in AP, UAE, SA and IN) 	SUA...	4830
On/Off and PWM actuators *)	Thermal actuator (for radiator valves) AC 230 V, NO 	STA23...	4884
	Thermal actuator (for radiator valves) AC 24 V, NO 	STA73... *)	4884 *)
	Thermal actuator AC 230 V (for small valves 2.5 mm), NC 	STP23...	4884
	Thermal actuator AC 24 V (for small valves 2.5 mm) NC 	STP73... *)	4884 *)
3-position actuators	Electrical actuator, 3-position (for radiator valves) 	SSA31...	4893
	Electrical actuator, 3-position (for 2- and 3-port valves / V...P45) 	SSC31...	4895

DC 0...10 V actuators

Electrical actuator, 3-position (for small valves 2.5 mm)		SSP31...	4864
Electrical actuator, 3-position (for small valves 5.5 mm)		SSB31...	4891
Electrical actuator, 3-position (for CombiValves VPI45)		SSD31...	4861
Electromotoric actuator, 3-position (for valves 5.5 mm)		SQS35...	4573
Electrical actuator, DC 0...10 V (for radiator valves)		SSA61...	4893
Electrical actuator, DC 0...10 V (for 2- and 3-port valves / V...P45)		SSC61...	4895
Electrical actuator, DC 0...10 V (for small valves 2.5 mm)		SSP61...	4864
Electrical actuator, DC 0...10 V (for small valves 5.5 mm)		SSB61...	4891
Electrical actuator, DC 0...10 V (for CombiValves VPI45)		SSD61...	4861
Electromotoric actuator, DC 0...10 V (for valves 5.5 mm)		SQS65...	4573
Electrothermal actuator, AC 24 V, NC, DC 0...10 V, 1 m		STA63	4884
Electrothermal actuator, AC 24 V, NO, DC 0...10 V, 1 m		STP63	4884

*) Note: With PWM control, it is not possible to ensure exact parallel running of 2 or more thermal actuators.

If several fan coil systems are controlled by the same room thermostat, preference should be given to motorized actuators with On/Off or 3-position control.

Note For the parallel operation of the actuators, refer to information in the data sheets of the selected actuators and to this list, depending on which value is lower:

Maximum number of actuators in parallel on the RDG100..

- Max. 6 SS...31... actuators (3-pos)
 - Max. 4 ST...23.. if used with On/Off control signal
 - Max. 10 SFA..., SUA..., MVI..., MXI.. On/Off actuators
- Parallel operation of SQS35 is NOT possible.

Maximum number of actuators in parallel on the RDG110

- Max. 10 On/Off actuators

Maximum number of actuators in parallel on the RDG160T

- Max. 10 SS...61.. actuators (DC)
- Max. 10 ST..23/63/73... actuators (DC or On/Off)
- Max. 10 SFA..., SUA..., MVI..., MXI ... On/Off actuators
- Max. 10 SQS65 actuators (DC)

Accessories

Description	Product no.	Data Sheet
Changeover mounting kit (50 pcs / package)	ARG86.3	3009

Ordering

Product no.	Stock number	Designation
RDG100	S55770-T158	Room thermostat
RDG100T	S55770-T159	Room thermostat, with timer
RDG100T/H	S55770-T235	Room thermostat, with timer, landscape housing
RDG110	S55770-T160	Room thermostat with relay outputs
RDG160T	S55770-T343	Room thermostat with timer and DC output for valve and fan

Order the **IRA211** infrared remote control separately.

Order valve actuators separately.

Mechanical design

The room thermostat consists of 2 parts:

- Plastic housing which accommodates the electronics, the operating elements and the room temperature sensor
- Mounting plate with the screw terminals

The housing engages in the mounting plate and is secured with 2 screws.

Operation and settings

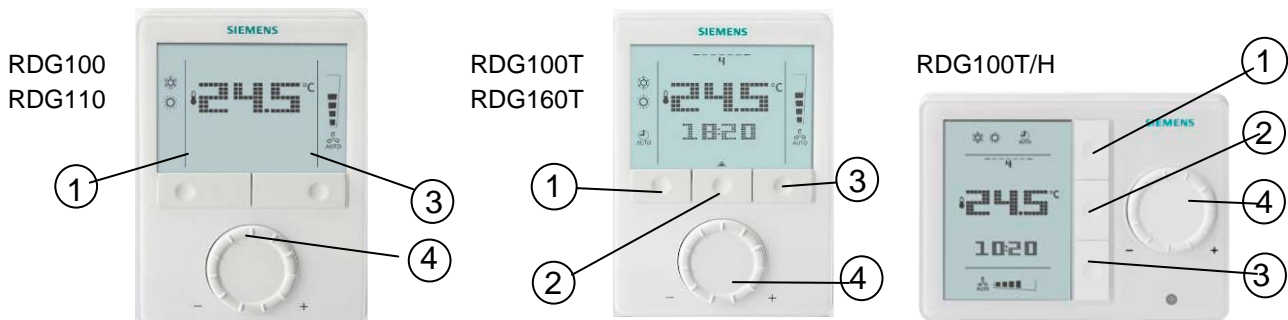

- 1 Operating mode selector / Esc
- 2 Button to enter the time and to set the timers
- 3 Fan mode selector / OK
- 4 Rotary knob for setpoint and parameter adjustment

Display

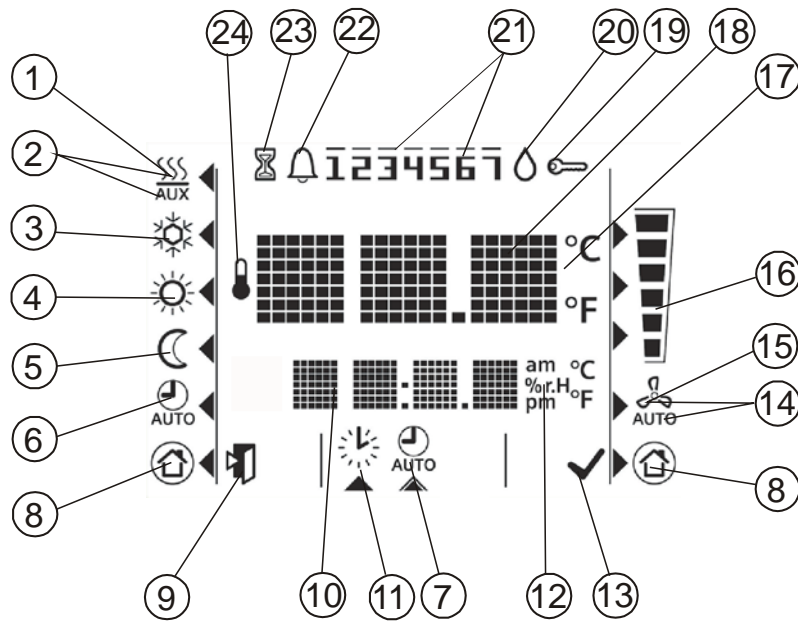

#	Symbol	Description	#	Symbol	Description	
1		Heating mode	14		Automatic fan	
2		Heating mode auxiliary heater on (2nd stage)	15		Manual fan	
3		Cooling mode	16			Fan speed 1
4		Comfort mode				Fan speed 2
5		Economy mode				Fan speed 3
6		Auto Timer mode	17		Degrees Celsius Degrees Fahrenheit	
7		View and set Auto Timer program				
8		Protection	18		Digits for room temperature and setpoint display	
9		Escape	19		Button lock	
10		Digits for time, room temperature, setpoint, etc.	20		Condensation in room (dewpoint sensor active)	
11		Setting the time of day and the weekday	21		Weekday 1...7: 1 = Monday / 7 = Sunday	
12		Morning: 12-hour format Afternoon: 12-hour format	22		Fault	
			23		Temporary timer function (visible when operating mode is temporarily extended due to prolonged presence or absence)	
13		Confirmation of parameters	24		Indicates that room temperature is displayed	

Mounting and installation

Do not mount on a wall in niches or bookshelves, behind curtains, above or near heat sources, or exposed to direct solar radiation. Mount about 1.5 m above the floor.

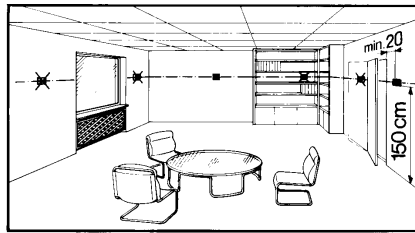

Mounting



- The room thermostat must be mounted in a clean, dry indoor place and must not be exposed to drip or splash water.

Wiring



See Mounting Instructions (M3181) enclosed with the thermostat.

- Comply with local regulations to wire, protection and earth the thermostat.
- The device has no internal fuse for supply lines to fan and actuators. To avoid risk of fire and injury due to short-circuits, the AC 230 V mains supply line must have a circuit breaker with a rated current of no more than 10 A.
- Properly size the cables to the thermostat, fan and valve actuators for AC 230 V mains voltage.
- Use only valve actuators rated for AC 230 V on RDG100..., RDG110 and on RDG160T if AC 230V is connected to the "L" terminal.
- The wiring cross section used for power supply (L, N), fan (Q1, Q2, Q3, N) and 230 V outputs (Yx - N) must be adapted to the preceding overload protection elements (10A) under all circumstances. Comply under all circumstances with local regulations.
- Isolate the cables of inputs X1-M / X2-M and D1-GND if the conduit box carries AC 230 V mains voltage.
- On the RDG100.. and RDG110, inputs X1-M and X2-M carry mains potential. If the sensor's cables are extended, they must be suited for mains voltage.
- Inputs X1-M, X2-M or D1-GND of different units (e.g. summer / winter switch) may be connected in parallel with an external switch. Consider overall maximum contact sensing current for switch rating.
- Selectable relay function (RDG160T). Consider overall maximum current through the relays.
- Disconnect power supply before removing the thermostat from the mounting plate!



Commissioning

Select the application and the type of control output via the DIP switches before fitting the thermostat to the mounting plate.

After power is applied, the thermostat carries out a reset during which all LCD segments flash, indicating that the reset was correct. After the reset, which takes about 3 seconds, the thermostat is ready for commissioning by qualified HVAC staff.

The control parameters of the thermostat can be set to ensure optimum performance of the entire system (see Basic Documentation P3181).

Control sequence

- The control sequence may need to be set via parameter P01 depending on the application. The factory setting for the 2-pipe application is "Cooling only"; and "Heating and cooling" for the 4-pipe application.

Compressor-based application

- When the thermostat is used in connection with a compressor, the minimum output on-time (parameter P48) and off-time (parameter P49) for Y11/Y21 must be adjusted to avoid damage to the compressor and shortening its life.

- Calibrate sensor
 - Recalibrate the temperature sensor if the room temperature displayed on the thermostat does not match the room temperature measured. To do this, change parameter P05.
- Adaptive temperature compensation for el. heating
 - If an electrical heating is directly connected to output Y21, the load current of the electrical heating should be indicated in parameter P46. (RDG110 only, Index D and heating only). Default setting: 1 A for loads up to 1 A.
- Setpoint and setpoint range limitation
 - We recommend to review the setpoints and setpoint ranges (parameters P08...P12) and change them as needed to achieve maximum comfort and save energy.

Disposal



The devices are considered electronics devices for disposal in terms of European Directive 2012/19/EU and may not be disposed of as domestic waste.

- Dispose of the device via the channels provided for this purpose.
- Comply with all local and currently applicable laws and regulations.

Technical data

RDG100... / RDG110

Power supply

Rated voltage	AC 230 V
Frequency	50/60 Hz
Power consumption RDG100...	Max. 8 VA / 1 W
Power consumption RDG110	Max. 11 VA / 2 W

No internal fuse

External preliminary protection with max. C 10A circuit breaker

Required in all cases

Outputs



Note!

Fan control Q1, Q2, Q3-N	AC 230 V
Rating min, max resistive (inductive)	AC 5 mA...5(4) A

Fans must NOT be connected in parallel!

Connect one fan directly, for additional fans, one relay for each speed.

Caution

No internal fuse

External preliminary protection with max. C 10 A circuit breaker in the supply line required under all circumstances.

Control outputs

Y1, Y2, Y3, Y4-N (RDG100...)	AC 230 V, AC 8 mA...1 A
Power limitation	3A fast microfuse, cannot be exchanged
Y11-N // Y21-N (NO) (RDG110)	AC 230 V, AC 5 mA...5(3) A

Caution

No internal fuse

External preliminary protection with max. C 10 A circuit breaker in the supply line required under all circumstances.

Inputs

Multifunctional inputs

X1-M / X2-M

Temperature sensor input

Type	QAH11.1 (NTC)
Temperature range	0...49 °C
Cable length	Max. 80 m

Digital input

Operating action	Selectable (NO/NC)
Contact sensing	DC 0...5 V, max. 5 mA
Parallel connection of several thermostats for one switch	Max. 20 thermostats per switch. Do not mix with D1!
Insulation against mains	N/A, mains potential

11/19

D1-GND	Operating action	Selectable (NO/NC)
	Contact sensing	SELV DC 6...15 V, 3...6 mA
	Parallel connection of several thermostats for one switch	Max. 20 thermostats per switch.
	Insulation against mains	Do not mix with X1 / X2! 3.75 kV, reinforced insulation
Function input		Selectable
	External temperature sensor, changeover sensor, operating mode switchover contact, dewpoint monitor contact, enable electrical heater contact, fault contact	

RDG160T

 Power supply

Rated voltage	AC 24 V
DC 24 V : Make sure to connect G to + and G0 to -	DC 24 V
Frequency	50/60 Hz
Power consumption	Max. 2 VA / 1 W

No internal fuse
External preliminary protection in G-Go lines with max C 10A circuit breaker
Required in all cases

Outputs

Q1 / Q2 / Q3 / L - N (relay)	AC 24...230 V
------------------------------	---------------

Use for 3-speed fan control	5 mA...5(4) A
-----------------------------	---------------

Rating min, max resistive (inductive)

Fans must NOT be connected in parallel!

Connect one fan directly, for additional fans, one relay for each speed.

Use for actuator control (Q1, Q2)

Q1 - rating min, max resistive / inductive 5 mA...1 A

Q2 - rating min, max resistive (inductive) 5 mA...5(4) A

Max total load current Q1+Q2(+Q3) 5 A

Use for external equipment (Q1, Q2, Q3)

Rating min, max resistive / inductive Qx 5 mA...1 A

Max total load current Q1+Q2+Q3 2 A

No internal fuse

External preliminary protection in L line with max C 10A circuit breakers

Required in all cases

ECM fan control Y50 - G0	SELV DC 0...10 V, Max. ±5 mA
--------------------------	---------------------------------

Actuator control Y10 - G0 / Y20 - G0 (G)	SELV DC 0...10 V, Max. ±1 mA
--	---------------------------------

Inputs

Multifunctional inputs	SELV
------------------------	------

X1-M / X2-M

Temperature sensor input

Type QAH11.1 (NTC)

Temperature range 0...49 °C

Cable length Max. 80 m

Digital input

Operating action Selectable (NO/NC)

Contact sensing DC 0...5 V, max. 5 mA





Parallel connection of several thermostats for one switch Max. 20 thermostats per switch

D1-GND

Operating action Selectable (NO/NC)

Contact sensing DC 6...15 V, 3...6 mA

Parallel connection of several thermostats for one switch Max. 20 thermostats per switch.

	Function of inputs	Selectable	
	External room temperature sensor, heating/cooling changeover sensor, operating mode switchover contact, dewpoint monitor contact, enable electric heater contact, fault contact, monitoring input, supply air temperature	X1: P38 X2: P40 D1: P42	
Operational data, all types	Switching differential, adjustable		
	Heating mode (P30)	2 K (0.5...6 K)	
	Cooling mode (P31)	1 K (0.5...6 K)	
	Setpoint setting and setpoint range		
	 Comfort mode (P08)	21 °C (5...40 °C)	
	 Economy mode (P11-P12)	15 °C/30 °C (OFF, 5...40 °C)	
	 Protection (P65-P66)	8 °C/OFF (OFF, 5...40 °C)	
	Multifunctional inputs X1 / X2 / D1	Selectable	
	Input X1	Ext. temperature sensor (P38=1)	
	Input X2	Changeover sensor (P40=2)	
	Input D1	Operating mode switchover (P42=3)	
	Built-in room temperature sensor		
	Measuring range	0...49 °C	
	Accuracy at 25 °C	< ± 0.5 K	
	Temperature calibration range	± 3.0 K	
Settings and display resolution			
Setpoints	0.5 °C		
Current temperature value displayed	0.5 °C		
Environmental conditions	Operation	As per IEC 721-3-3	
	Climatic conditions	Class 3K5	
	Temperature	0...50 °C	
	Humidity	<95% r.h.	
	Transport	As per IEC 721-3-2	
	Climatic conditions	Class 2K3	
	Temperature	-25...65 °C	
	Humidity	<95% r.h.	
	Mechanical conditions	Class 2M2	
	Storage	As per IEC 721-3-1	
	Climatic conditions	Class 1K3	
	Temperature	-25...65 °C	
	Humidity	<95% r.h.	
	Standards and directives	EU conformity (CE)	
		Product standards	
Automatic electric controls for household and similar use		EN60730-1	
Special requirements for temperature-dependent controls		EN60730-2-9	
Electronic control type		2.B (micro-disconnection on operation)	
Electromagnetic compatibility		2004/108/EC	
Emissions		EN60730-1, EN50491-5-2	
Immunity		EN60730-1, EN50491-5-2 EN50491-5-3	
Low-voltage directive		2006/95/EC	
Electrical safety		EN60730-1, EN50491-3	
 RCM Mark conformity (Emission)		AS/NZS 61000-6-3	



Reduction of hazardous substances

2011/65/EU
EN50581

Safety class

II as per EN60730

Pollution class

Normal

Degree of protection of housing

IP30 to EN60529

Environmental
Compatibility

The product environmental declaration CE1E3181¹⁾ contains data on environmentally compatible product design and assessments (RoHS compliance, materials composition, packaging, environmental benefit, disposal).

General

Connection terminals

Solid wires or prepared
stranded wires
1 x 0.4...2.5 mm²
or 2 x 0.4...1.5 mm²

Note: For sensors on inputs X1, X2, or D1, the cable length is max. 80 m

Minimal wiring cross section on

min 1.5 mm²

L, N, Q1, Q2, Q3, Y1, Y2, Y3, Y4, Y11, Y21

Housing front color

RAL 9003 white

Weight

RDG100... / RDG110

0.30 kg

RDG160T

0.32 kg

*) The documents can be downloaded from <http://siemens.com/bt/download>.

Connection terminals

RDG100,
RDG100T,
RDG100T/H

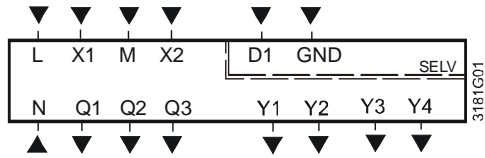

RDG110

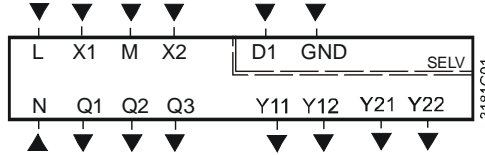

RDG160T

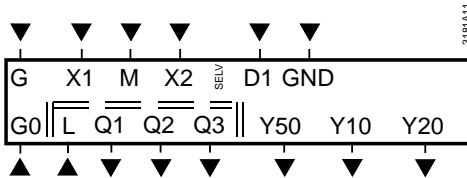

- L, N Operating voltage AC 230 V
X1, X2 Multifunctional input for temperature sensor (e.g. QAH11.1) or potential-free switch
Factory setting :
- X1 = external room temperature sensor
- X2 = sensor or switch for heating / cooling changeover
Change of setting: Parameters P38, P40
- M Measuring neutral for sensor and switch
D1, GND Multifunctional input for potential-free switch.
Factory setting: Operating mode switchover contact
Change of setting: Parameter P42
- Q1 Control output fan speed "low" AC 230 V
Q2 Control output fan speed "medium" AC 230 V
Q3 Control output fan speed "high" AC 230 V
- Y1...Y4 Control output "Valve" AC 230 V (NO, for normally closed valves), output for electric heater via external relay
Y11, Y21 Control output "Valve" AC 230 V (NO, for normally closed valves), output for compressor or electric heater
Y12, Y22 Control output "Valve" AC 230 V (NC, for normally open valves)
- G, G0 Operating voltage AC / DC 24 V
Note: For DC24 V: G0 = -; G = +
L (-N) Power supply relay output AC 24...230 V
Y10, Y20 Control output for DC 0...10 V actuator
Y50 Control output "Fan" DC 0...10 V
Q1...3 Control output fan, valve, el. heater or ex. equipment

Connection diagrams

RDG100...

Application

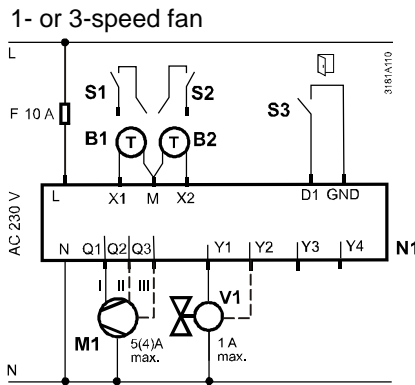

- N1 Room thermostat RDG100..
- M1 1- or 3-speed fan
- V Valve actuators:
On/Off or PWM, 3-position, heating, cooling, radiator, heating / cooling, 1st or 2nd stage
- E1 Electric heater
- S1, S2 Switch (keycard, window contact, etc.)
- S3 Switch at SELV input (keycard, window contact)
- B1, B2 Temperature sensor (return air temperature, external room temperature, changeover sensor, floor temperature limit, etc.)
- Q Relay outputs
- Y1...Y4 Triac outputs
- YH Heating valve actuator
- YC Cooling valve actuator
- YHC Heating / cooling valve actuator
- YR Radiator valve actuator
- E1 Electric heater with relay / contactor Y
- 1st / 2nd 1st / 2nd stage

- 2-pipe

YHC

- 2-pipe & radiator
- 4-pipe
- 2-stage

YHC YR
YH YC
1st 2nd

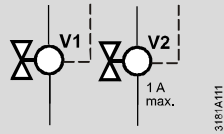

- 2-pipe & el. heater

YHC E1

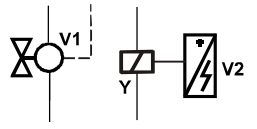

- 4-pipe & el. heater

YH YC
E1

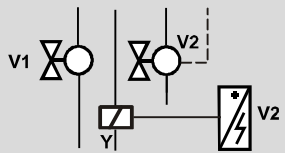

RDG110...

Application

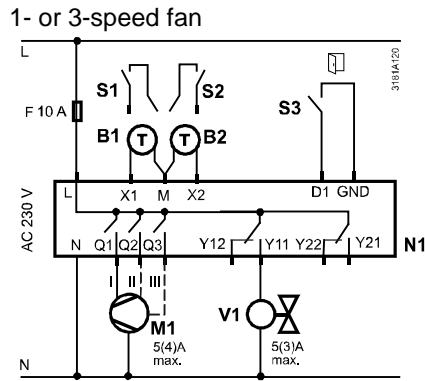

- 2-pipe YHC

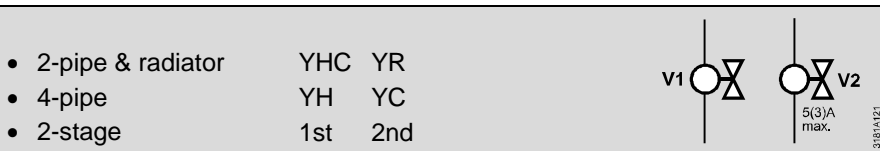

- 2-pipe & el. heater YHC E1

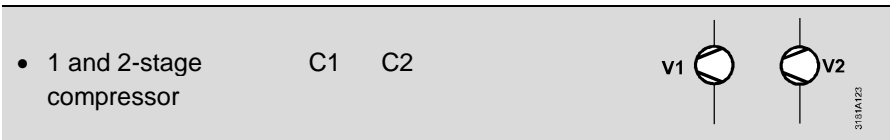

- Compressor & el. heater C1 E1

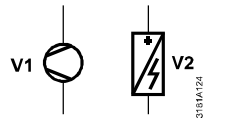

- Compressor & reversing valve RV C1

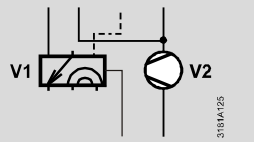

- N1 Room thermostat RDG110..
- M1 1- or 3-speed fan
- V Valve actuators:
On/Off or PWM, 3-position, heating, cooling, radiator, heating / cooling, 1st or 2nd stage
- E1 Electric heater
- C1, C2 Compressor
- S1, S2 Switch (keycard, window contact, etc.)
- S3 Switch at SELV input (keycard, window contact)
- B1, B2 Temperature sensor (return air temperature, external room temperature, changeover sensor, floor temperature limit, etc.)
- RV Reversing valve
- Q Relay outputs
- Y11...Y22 Relay outputs
- YH Heating valve actuator
- YC Cooling valve actuator
- YHC Heating / cooling valve actuator
- YR Radiator valve actuator
- E1 Electric heater max. 5 A
- 1st / 2nd 1st / 2nd stage
- C1 / C2 Compressor 1st and 2nd stage
- RV Reversing valve

RDG160T

DC 0...10 V fan

1- / 3-speed fan

Application

V1
↓
V2
↓

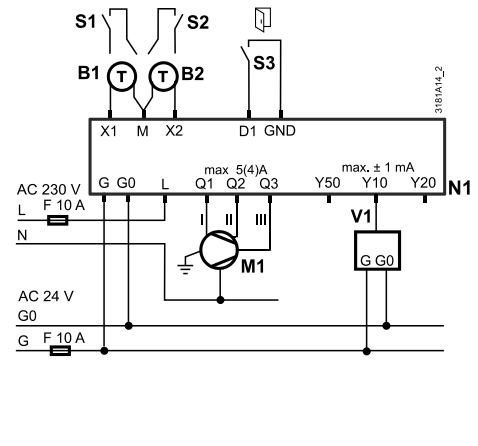
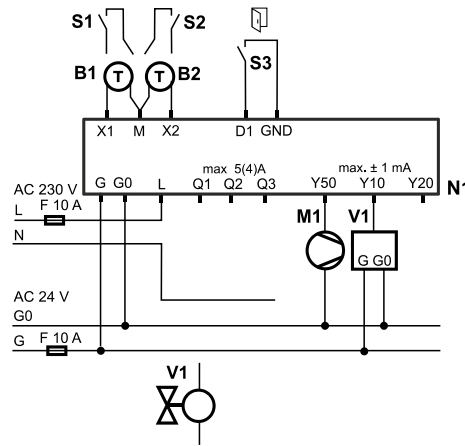

- 2-pipe YHC

- 2-pipe and radiator YHC YR
- 4-pipe YH YC
- 2-stage 1st 2nd

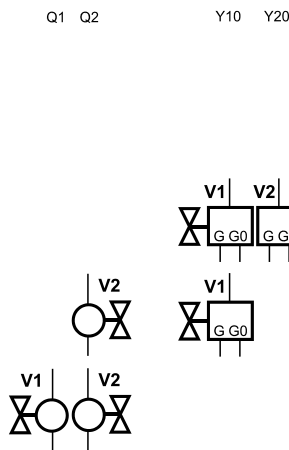

- 2-pipe and electric heater YHC E1

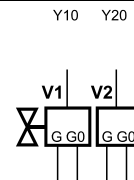
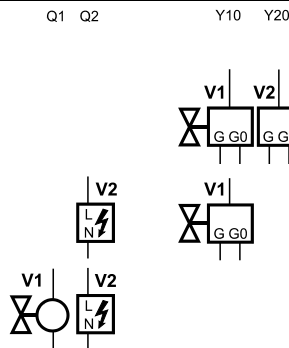

- Compressor 1st 1-stage



- Compressor 1st 2nd 2-stage

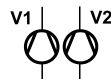

N1 Room thermostat RDG160T
 F External circuit breaker
 S1...S3 Switch (keycard, window contact, presence detector, etc.)
 B1, B2 Temperature sensor (return air temperature, external room temperature, changeover sensor, etc.)

M1 1- or 3-speed fan, DC 0...10 V fan
 V1, V2 Valve actuators: On/Off, DC 0...10 V, heating, cooling, radiator, 1st or 2nd stage
 YH Heating valve actuator
 YC Cooling valve actuator
 YHC Heating / cooling valve actuator
 YR Radiator valve actuator
 1st / 2nd 1st / 2nd stage

Dimensions

All dimensions in mm

