

SIEMENS



Heating and D.h.w. Controller RVL482 Basic Documentation

Edition: 1.0
Controller series: A
CE1P2542en
20.05.2008

Building Technologies

Siemens Switzerland Ltd
Building Technologies Group
International Headquarters
Gubelstrasse 22
CH – 6301 Zug
Tel. +41 41 724 24 24
Fax +41 41 724 35 22
www.sbt.siemens.com

2/127

© 2008 Siemens Switzerland Ltd
Subject to alteration

Contents

1	Summary	13
1.1	Brief description and key features	13
1.2	Equipment combinations	13
1.2.1	Suitable sensors	13
1.2.2	Suitable room units	14
1.2.3	Suitable actuators	14
1.2.4	Communication	14
1.2.5	Reception of heat demand signal	14
1.2.6	Documentation	14
2	Use	15
2.1	Types of plant	15
2.2	Types of houses and buildings	15
2.3	Types of heating systems	15
2.4	Functions	15
3	Fundamentals	17
3.1	Key technical features	17
3.1.1	Plant types with regard to heating circuit control	17
3.1.2	Plant types with regard to d.h.w. heating	17
3.1.3	Function blocks	17
3.2	Plant types	18
3.2.1	Selectable combinations	18
3.2.2	Heating circuit plant types	19
3.2.3	D.h.w. plant types	21
3.3	Setting levels, function blocks and plant types	23
3.4	Heating circuit operating modes	24
3.4.1	Automatic operation	24
3.4.2	Continuously REDUCED heating	24
3.4.3	Continuously NORMAL heating	24
3.4.4	Protection	24
3.5	D.h.w. operating modes	24
3.6	Manual operation	25
3.7	Plant type and operating mode	25
3.8	Operating state and operational level	26
4	Acquisition of measured values	27
4.1	Room temperature (A6, B5)	27
4.1.1	Measurement	27
4.1.2	Handling faults	27

4.1.3	Room model.....	27
4.2	Flow temperature (B1)	27
4.2.1	Measurement.....	27
4.2.2	Handling faults	28
4.3	Boiler temperature (B2).....	28
4.3.1	Measurement.....	28
4.3.2	Handling faults	28
4.4	Outside temperature (B9)	28
4.4.1	Measurement.....	28
4.4.2	Handling faults	28
4.5	Return temperature (B7)	29
4.5.1	Measurement.....	29
4.5.2	Handling faults	29
4.6	D.h.w. flow temperature (B3)	29
4.6.1	Measurement.....	29
4.6.2	Handling faults	29
4.7	D.h.w. storage tank temperature (B31, B32)	30
4.7.1	Measurement.....	30
4.7.2	Handling faults	30
4.8	Collector temperature (B6).....	31
4.8.1	Measurement.....	31
4.8.2	Handling faults	31
4.9	Solar sensor (U1).....	31
4.9.1	Measurement.....	31
4.9.2	Handling faults	31
4.10	Wind sensor (U2).....	31
4.10.1	Measurement.....	31
4.10.2	Handling faults	31
5	Function block "Enduser space heating"	32
5.1	Operating lines.....	32
5.2	Setpoints	32
5.2.1	General	32
5.2.2	Frost protection for the building	32
5.3	Heating program	32
5.4	Holiday program.....	33
6	Function block "Enduser d.h.w."	34
6.1	Operating lines.....	34
6.2	Setpoint.....	34
6.3	Actual value	34
7	Function block "Enduser general"	35

7.1	Operating lines	35
7.2	Switching program 2.....	35
7.3	Time of day and date.....	35
7.4	Indication of errors.....	36
8	Function block "Plant type"	37
8.1	Operating line	37
8.2	General.....	37
9	Function block "Type of heat source".....	38
9.1	Operating line	38
9.2	Setting	38
10	Function block "Modulating burner"	39
10.1	Operating lines	39
10.2	Description.....	39
10.3	Control.....	39
11	Function block "Cascade slave"	40
11.1	Operating lines	40
11.2	Mode of operation.....	40
11.2.1	Release integral (KFI) for boiler sequence	40
11.2.2	Reset integral (KRI) for the boiler sequence	40
12	Function block "Space heating"	41
12.1	Operating lines	41
12.2	ECO function	41
12.2.1	Compensating variables and auxiliary variables	41
12.2.2	Heating limits.....	42
12.2.3	Mode of operation.....	42
12.3	Room temperature source.....	43
12.4	Optimization.....	43
12.4.1	Definition and purpose.....	43
12.4.2	Fundamentals.....	43
12.4.3	Process.....	44
12.4.4	Room model temperature.....	44
12.4.5	Optimum stop control	45
12.4.6	Quick setback.....	45
12.4.7	Optimum start control	45
12.4.8	Boost heating.....	46
12.5	Room functions.....	47
12.5.1	Maximum limitation of the room temperature	47
12.5.2	Room influence.....	47
12.6	Heating curve	48

12.6.1	Purpose.....	48
12.6.2	Basic setting.....	48
12.6.3	Deflection	49
12.6.4	Parallel displacement of the heating curve	49
12.6.5	Display of the setpoints.....	50
12.7	Generation of setpoint.....	50
12.7.1	Weather-compensated control.....	50
12.7.2	Demand-compensated control.....	50
13	Function block "3-position actuator heating circuit"	51
13.1	Operating lines.....	51
13.2	Limitations.....	51
13.2.1	Flow temperature limitations	51
13.2.2	Setpoint rise	51
13.2.3	Impact of d.h.w. heating.....	52
13.3	3-position control.....	52
13.4	Excess mixing valve temperature	52
13.5	Pulse lock.....	52
14	Function block "Boiler"	53
14.1	Operating lines.....	53
14.2	Operating mode	53
14.3	Limitations.....	54
14.3.1	Maximum limitation of the boiler temperature	54
14.3.2	Minimum limitation of the boiler temperature	54
14.3.3	Actions during d.h.w. heating.....	54
14.4	Control with a multistage burner	54
14.4.1	Control with a single-stage burner	54
14.4.2	Control with a 2-stage burner.....	55
14.5	Control with a modulating burner	57
14.5.1	Setting parameters.....	57
14.5.2	Control	57
14.6	Frost protection for the boiler	57
14.7	Protective boiler startup	58
14.7.1	Plant types 2-x and 4-x:.....	58
14.7.2	Plant types 3-x and 5-x.....	58
14.8	Protection against boiler overtemperatures	59
15	Function block "Pump M1"	60
15.1	Operating lines.....	60
15.2	Description	60
15.2.1	Plant types 2-x and 4-x.....	60
15.2.2	Plant types 3-x and 5-x.....	60

16	Function block "Setpoint of return temperature limitation"	61
16.1	Operating line	61
16.2	Description.....	61
17	Function block "Type of limitation of return temperature"	62
17.1	Operating line	62
17.2	Settings.....	62
17.3	Acquisition of measured values.....	62
17.4	Minimum limitation of the return temperature.....	62
17.4.1	Minimum limitation through reduction of the consumer setpoints.....	62
17.4.2	Mode of operation with a single device (with no bus).....	63
17.4.3	Mode of operation in interconnected plants.....	63
17.4.4	Minimum limitation through reduction of the consumer setpoints, with inclusion of the bypass pump	64
17.4.5	Minimum limitation with mixing valve in the boiler return.....	64
17.5	Maximum limitation of the return temperature.....	64
17.5.1	Maximum limitation acting on the mixing valve in the heating circuit	64
17.5.2	Maximum limitation acting on the boiler	65
18	Function block "Bivalent maximum limitation of the return temperature"	66
18.1	Operating lines	66
18.2	Description.....	66
19	Function block "3-position actuator mixing circuit"	67
19.1	Operating lines	67
19.2	Control	67
20	Function block "Integral action time maximum limitation of the return temperature"	68
20.1	Operating lines	68
20.2	Description.....	68
21	Function block "Assignment of d.h.w. heating"	69
21.1	Operating lines	69
21.2	Assignment of d.h.w. heating	69
22	Function block "Circulating pump"	70
22.1	Operating line	70
22.1.1	General mode of operation.....	70
22.2	Operation of circulating pump during the holiday period	71
22.3	Frost protection for d.h.w.....	71
22.3.1	Frost protection in the d.h.w. storage tank	71
22.3.2	Frost protection in the d.h.w. storage tank flow	71

22.3.3	Frost protection in the secondary d.h.w. flow.....	71
23	Function block "Release, priority and flow temperature setpoint of d.h.w.".....	72
23.1	Operating lines.....	72
23.2	Release.....	72
23.2.1	Function.....	72
23.2.2	Release programs.....	73
23.2.3	D.h.w heating during the holiday period.....	73
23.3	Priority and flow temperature setpoint	74
23.3.1	Settings.....	74
23.3.2	D.h.w. priority.....	74
23.3.3	Absolute priority	74
23.3.4	Shifting priority	74
23.3.5	No priority.....	75
23.3.6	Flow temperature setpoint	75
23.3.7	Maximum selection	75
23.3.8	D.h.w.....	75
24	Function block "D.h.w. storage tank"	76
24.1	Operating lines.....	76
24.2	D.h.w. charging.....	76
24.2.1	D.h.w. charging with hot water.....	76
24.2.2	Charging with hot water and electricity	76
24.3	D.h.w. temperature and d.h.w. switching differential	77
24.4	Boost of the d.h.w. charging temperature.....	78
24.5	Maximum d.h.w. charging time	78
24.6	Setpoint of the legionella function	79
24.7	Forced charging.....	79
24.8	Protection against discharging.....	80
24.8.1	Purpose.....	80
24.8.2	Mode of operation	80
24.8.3	Flow temperature	80
24.9	Manual d.h.w. charging.....	80
25	Function block "3-position actuator for d.h.w."	81
25.1	Operating lines.....	81
25.2	Function	81
25.2.1	Flow temperature boost	81
25.2.2	D.h.w temperature control.....	81
25.3	Pulse lock.....	81
26	Function block "Derivative action time d.h.w. heating via heat exchanger"	82

26.1	Operating line	82
26.2	Description.....	82
27	Function block "Multifunctional relay"	83
27.1	Operating lines	83
27.2	Functions	83
27.2.1	No function	83
27.2.2	Outside temperature switch.....	83
27.2.3	ON / OFF according to the time switch.....	84
27.2.4	Relay energized in the event of fault	84
27.2.5	Relay energized during occupancy time.....	84
27.2.6	Relay energized during occupancy time (including optimizations)	84
27.2.7	Relay energized, if there is demand for heat.....	84
27.2.8	Manually ON / OFF.....	84
28	Function block "Legionella function"	85
28.1	Operating lines	85
28.1.1	Periodicity of the legionella function	85
28.1.2	Point in time of the legionella function	85
28.1.3	Dwelling time at the legionella setpoint	85
28.1.4	Circulating pump operation during the legionella function.....	85
28.2	Mode of operation.....	86
29	Function block "Switching program 3"	87
29.1	Operating lines	87
29.2	Description.....	87
30	Function block "Service functions and general settings"	88
30.1	Operating lines	88
30.2	Display functions	88
30.2.1	Flow temperature setpoint.....	88
30.2.2	Heating curve	89
30.3	Commissioning aids	89
30.3.1	Simulation of the outside temperature.....	89
30.3.2	Relay test.....	90
30.3.3	Sensor test	90
30.3.4	Test of contacts H.....	91
30.4	Auxiliary functions.....	92
30.4.1	Frost protection for the plant.....	92
30.4.2	Flow alarm	92
30.4.3	Manual overriding of operating mode (contact H1)	93
30.4.4	Pump overrun	93
30.4.5	Pump kick	94

30.4.6	Winter- / summertime changeover.....	94
30.4.7	Gain of locking signal.....	94
30.5	Entries for LPB.....	95
30.5.1	Source of time of day.....	95
30.5.2	Outside temperature source.....	96
30.5.3	Addressing the devices.....	96
30.5.4	Bus power supply.....	97
30.5.5	Bus loading number.....	97
30.6	Heat demand inputs DC 0...10 V.....	97
31	Function block "Contact H2"	98
31.1	Operating lines.....	98
31.2	Description.....	98
32	Function block "External inputs"	99
32.1	Operating lines.....	99
32.2	Contact H2.....	99
32.3	Voltage inputs.....	99
32.3.1	Display.....	99
32.3.2	Input U1.....	99
32.3.3	Input U2.....	100
32.4	Hours run counter.....	101
32.5	Software version.....	101
32.6	Identification number of room unit.....	101
33	Function block "D.h.w. solar charging"	102
33.1	Operating lines.....	102
33.2	Functions.....	102
33.2.1	Temperature differential ON/OFF solar.....	102
33.2.2	Minimum charging temperature.....	103
33.2.3	Minimum runtime.....	104
33.2.4	Collector frost protection temperature.....	104
33.2.5	Collector temperature to protect against overheating.....	105
33.2.6	Storage tank recooling.....	105
33.2.7	Evaporation temperature of heat carrier.....	106
33.2.8	Maximum limitation of charging temperature.....	107
33.2.9	Storage tank temperature maximum limitation.....	107
33.2.10	Collector start function gradient.....	107
34	Function block "Locking functions"	109
34.1	Operating line.....	109
34.2	Description.....	109
35	Communication.....	110

35.1	Combination with room units	110
35.1.1	General.....	110
35.1.2	Combination with room unit QAW50	110
35.1.3	Combination with room unit QAW70	111
35.2	Combination with SYNERGYR central unit OZW30.....	113
35.3	Communication with other devices.....	113
36	Handling	114
36.1	Operation.....	114
36.1.1	General.....	114
36.1.2	Analog operating elements.....	115
36.1.3	Digital operating elements.....	116
36.1.4	Setting levels and access rights	116
36.2	Commissioning	117
36.2.1	Installation instructions	117
36.2.2	Operating lines	117
36.3	Installation	117
36.3.1	Mounting location	117
36.3.2	Mounting choices.....	117
36.3.3	Electrical installation	118
37	Engineering.....	119
37.1	Connection terminals.....	119
37.1.1	Low-voltage side.....	119
37.1.2	Mains voltage side.....	119
37.2	Connection diagrams.....	120
38	Mechanical design.....	121
38.1	Basic design	121
38.2	Dimensions.....	121
39	Technical data.....	122

1 Summary

1.1 Brief description and key features

- The RVL482 is a multifunctional heating controller for use in residential and non-residential buildings that have their own d.h.w. heating facility
- Suited for:
 - Heating zone control with or without room influence via weather-compensated flow temperature control and, simultaneously, demand-compensated boiler temperature control
 - Precontrol via demand-compensated boiler temperature control. Suited for integration into heat source cascades or heat generation systems (heat pump, solar, wood-fired boiler)
- For use in heating plants with own heat generation or in interconnected systems
- With regard to d.h.w. heating, the RVL482 is suited for plants with d.h.w. storage tanks, electric immersion heaters, solar d.h.w. heating and instantaneous systems with own heat exchangers
- The RVL482 has 21 plant types pre-programmed. When a certain type of plant is selected, all functions and settings required for that particular plant will be activated
- A multifunctional relay provides additional control functions, if required
- 2 separately scalable voltage inputs DC 0...10 V are used to receive heat demand signals from external consumers
- The RVL482 has connection facilities for one wind sensor and one solar sensor
- For the direct setting of the heating curve, the "little bar" is used. The heating curve can also be set in digital form. A setting knob is used for making room temperature readjustments
- All the other parameters are set digitally based on the operating line principle
- The RVL482 is capable of communicating with other units via LPB (Local Process Bus)
- Key design features: Operating voltage AC 230 V, CE conformity, overall dimensions to IEC 61554 (144 x 144 mm)

1.2 Equipment combinations

1.2.1 Suitable sensors

- For water temperatures:
Suitable are all types of temperature sensors that use a sensing element LG-Ni 1000. The following types are presently available:
 - Strap-on temperature sensor QAD22
 - Immersion temperature sensors QAE212...
 - Immersion temperature sensor QAP21.3 complete with connecting cable
 - Immersion temperature sensor QAP21.2 complete with connecting cable, for solar use
- For the room temperature: Suitable are all types of temperature sensors that use a sensing element LG-Ni 1000:
 - Room temperature sensor QAA24
- For the compensating variables
 - Outside sensor QAC22 (sensing element LG-Ni 1000)
 - Outside sensor QAC32 (sensing element NTC 575)
 - Wind sensor (commercially available, DC 0...10 V)
 - Solar impact sensor QLS60

1.2.2 Suitable room units

- Room unit QAW50
- Room unit QAW70

1.2.3 Suitable actuators

All types of actuators from Siemens with the following features can be used:

- Electromotoric or electrohydraulic actuators with a running time of 0.5...14.5 minutes
- 3-position control
- Operating voltage AC 24...230 V

1.2.4 Communication

Communication is possible with the following units:

- All types of controllers from Siemens with LPB communication capability
- SYNERGYR central unit OZW30 (software version 3.0 or higher)

Note

The heating controller RVL482 **cannot** be used as partner unit for the RVL469!

1.2.5 Reception of heat demand signal

The 2 separately scalable inputs DC 0...10 V are used to receive heat demand signals from other units.

1.2.6 Documentation

<i>Document</i>	<i>Doc. number</i>	<i>Stock number</i>
Data Sheet RVL482	N2542	–
Operating Instructions (all RVL types)*	B2540	74 319 0616 0
Installation Instructions, languages de, en, fr, nl, sv, fi, da, it, es	G2542	74 319 0619 0
CE Declaration of Conformity (all RVL types)	T2540	–
Environmental Declaration	E2542	–
Data Sheet QAW50	N1635	–
Data Sheet QAW70	N1637	–
Data Sheet LPB Basic System Data	N2030	–
Data Sheet LPB Basic Engineering Data	N2032	–

* unilingual, available in de, en, fr, nl, sv, fi, da, it, es

2 Use

2.1 Types of plant

The RVL482 is suitable for all types of heating plant that use weather-compensated flow temperature control. In addition, it can be used for demand-compensated control of the main flow.

With regard to d.h.w. heating, the RVL482 is suited for plants with storage tanks or d.h.w. heating via heat exchangers (instantaneous d.h.w. heating) or via solar collector.

Main applications:

- Heating zones and d.h.w. heating with own heat generation
- Interconnected plants consisting of heat generation, several heating zones and central or decentral d.h.w. heating

2.2 Types of houses and buildings

Basically, the RVL482 is suited for the control of all types of heating plants in houses or buildings. It has been designed especially for:

- Multifamily houses
- Single-family homes
- Non-residential buildings

2.3 Types of heating systems

The RVL482 is suited for use with all standard heating systems, such as:

- Radiators
- Convectors
- Underfloor heating systems
- Ceiling heating systems
- Radiant panels

2.4 Functions

The RVL482 is used if one or several of the following functions is / are required:

- Weather-compensated flow temperature control and simultaneous demand-compensated control of the boiler temperature
- Demand-compensated boiler temperature control as precontrol
- Flow temperature control via a modulating seat or slipper valve
- Boiler temperature control via direct control of a single-stage, 2-stage or modulating burner
- D.h.w. storage tank charging through control of a charging pump or a mixing valve, with or without circulating pump
- D.h.w. heating via heat exchanger (instantaneous d.h.w. heating), with or without circulating pump
- Optimum start / stop control according to the selected 7-day program
- Quick setback and boost heating according to the selected 7-day program
- Reception and handling of heat demand signals from external consumers
- Inclusion of solar radiation and wind speed as additional compensating variables
- ECO function: Demand-dependent switching of the heating system based on the type of building construction and the outside temperature
- Multifunctional relay
- 7-day program for building occupancy with a maximum of 3 setback periods per day and daily varying occupancy schedules

- Own 7-day switching program for the release of d.h.w. heating
- Third 7-day switching program
- Input of 8 holiday periods per year
- Automatic summer- / wintertime changeover
- Display of parameters, actual values, operating states and error messages
- Communication with other units via LPB
- Remote operation via room unit and external switches
- Service functions
- Frost protection for the plant, the boiler and the house or building
- Minimum or maximum limitation of the return temperature
- Minimum and maximum limitation of the flow temperature
- Maximum limitation of the room temperature
- Periodic pump run
- Pump overrun
- Maximum limitation of the rate of setpoint increase
- Flow alarm (flow temperature control or boiler temperature control)
- Legionella function
- Manual d.h.w. charging

For the pre-programmed heating and d.h.w. heating circuits and their possible combinations, refer to section 3.2 "Plant types".

3 Fundamentals

3.1 Key technical features

The RVL482 offers 2 key technical features:

- The RVL482 has 5 heating circuit plant types and 4 d.h.w. plant types pre-programmed. When making use of all possible or practical combinations, there is a total of 21 plant types available
- All functions and their settings are combined in the form of function blocks

3.1.1 Plant types with regard to heating circuit control

In terms of heating circuit, the following plant types are available:

- Heating circuit plant type 1: "Heating circuit control with mixing group"
- Heating circuit plant type 2: "Heating circuit control with mixing group, boiler control"
- Heating circuit plant type 3: "Heating circuit control with mixing group, boiler control, maintained boiler return temperature with mixing valve"
- Heating circuit plant type 4: "Precontrol with boiler"
- Heating circuit plant type 5: "Precontrol with boiler, maintained boiler return temperature with mixing valve"

Heating circuit plant types 4 and 5 are suited for integration into heat source cascades or heat generation systems.

3.1.2 Plant types with regard to d.h.w. heating

In terms of d.h.w., the following plant types are available:

- D.h.w. plant type 0: "No d.h.w. heating"
- D.h.w. plant type 1: "D.h.w. heating with charging pump"
- D.h.w. plant type 2: "D.h.w. heating with mixing group"
- D.h.w. plant type 3: "D.h.w. heating with heat exchanger"
- D.h.w. plant type 4: "D.h.w. heating with electric immersion heater"

The d.h.w. plant types 1, 2 and 4 can be supported by solar systems, i.e. they allow for d.h.w. heating via solar collector.

3.1.3 Function blocks

The following function blocks are available:

- Function block "Enduser space heating"
- Function block "Enduser d.h.w."
- Function block "Enduser general"
- Function block "Plant type"
- Function block "Heat source type"
- Function block "Modulating burner"
- Function block "Cascade slave"
- Function block "Space heating"
- Function block "3-position actuator heating circuit"
- Function block "Boiler"
- Function block "Pump M1"
- Function block "Setpoint return temperature limitation"
- Function block "Type of limitation of return temperature"
- Function block "Bivalent maximum limitation of the return temperature"
- Function block "3-position actuator mixing valve in the return"
- Function block "Integral action time maximum limitation of the return temperature"
- Function block "Assignment of d.h.w."
- Function block "Circulating pump"
- Function block "Release, priority and flow temperature setpoint of d.h.w."

- Function block "D.h.w. storage tank"
- Function block "3-position actuator for d.h.w."
- Function block "Derivative action time d.h.w. heating via heat exchanger"
- Function block "Multifunctional relay"
- Function block "Legionella function"
- Function block "Switching program 3"
- Function block "Service functions and general settings"
- Function block "Contact H2"
- Function block "External inputs"
- Function block "Solar d.h.w. heating"
- Function block "Locking functions"

For each function block, the required settings are available in the form of operating lines. On the following pages, a description of the individual functions per block and line is given.

3.2 Plant types

The RVL482 has 21 plant types pre-programmed; the functions required for each type of plant are ready assigned. When commissioning the installation, the relevant plant type must be selected.

Each plant type consists of a heating circuit and a d.h.w. circuit. When making use of all possible or practical combinations, there is a total of 21 plant types available

3.2.1 Selectable combinations

<i>Combinations</i>	<i>Type of heating circuit</i>	<i>Type of d.h.w. heating</i>
1-0	Heating circuit control with mixing group	No d.h.w.
1-1		Storage tank with charging pump
1-2		Storage tank with mixing valve
1-3		Heat exchanger
1-4		With electric immersion heater
2-0	Heating circuit control with mixing group, boiler control	No d.h.w.
2-1		Storage tank with charging pump
2-2		Storage tank with mixing valve
2-3		Heat exchanger
2-4		With electric immersion heater
3-0	Heating circuit control with mixing group, boiler control, maintained boiler return temperature with mixing valve	No d.h.w.
3-1		Storage tank with charging pump
3-4		With electric immersion heater
4-0	Precontrol with boiler	No d.h.w.
4-1		Storage tank with charging pump
4-2		Storage tank with mixing valve
4-3		Heat exchanger
4-4		With electric immersion heater
5-0	Precontrol with boiler, maintained boiler return temperature with mixing valve	No d.h.w.
5-1		Storage tank with charging pump
5-4		With electric immersion heater

Notes on the plant diagrams with the different types of space heating and d.h.w. circuits are given in the following sections:

- Symbols ○ and □ indicate where and how the space heating circuit is connected to the d.h.w. circuit. where:
 - representing the flow
 - representing the return
- The numbers beneath these symbols indicate the type of d.h.w. circuit which can be combined

3.2.2 Heating circuit plant types

Heating circuit plant type 1

Heating circuit control with mixing group

Space heating with weather-compensated flow temperature control, 3-position control acting on the heating group's mixing valve.

Outside temperature signal from own outside sensor or data bus. With or without room influence, with or without solar and wind compensation. Heating up and setback according to the heating program.

Can be combined with d.h.w. types:

- with types 1, 2 and 3 via hydraulic connection at ○ and □
- with type 4 without hydraulic connection

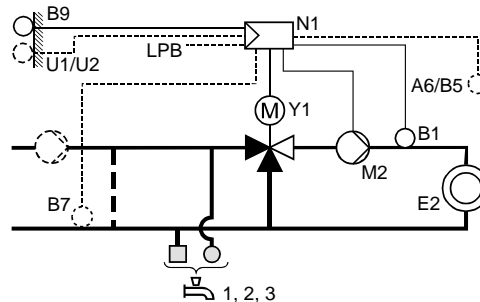

Heating circuit plant type 2

Heating circuit control with mixing group, boiler control

Space heating with weather-compensated flow temperature control, 3-position control acting on the heating group's mixing valve. Simultaneous demand-compensated control of the boiler temperature, 2- or 3-position control acting on the burner.

Outside temperature signal from own outside sensor or via data bus. With or without room influence, with or without solar and wind compensation. Heating up and setback according to the heating program.

Can be combined with d.h.w. types:

- with types 1, 2 and 3 via hydraulic connection at ○ and □
- with type 4 without hydraulic connection

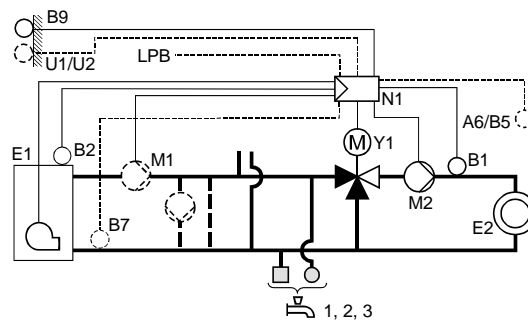

Heating circuit plant type 3

Heating circuit control with mixing group, boiler control, maintained boiler return temperature with mixing valve

Space heating with weather-compensated flow temperature control, 3-position control acting on the heating group mixing valve. Simultaneous demand-compensated control of the boiler temperature, 2- or 3-position control acting on the burner.

Outside temperature signal from own outside sensor or data bus. With or without room influence, with or without solar and wind compensation. Heating up and setback according to the heating program.

Minimum limitation of the return temperature with own mixing valve.

Can be combined with d.h.w. types:

- with type 1 via hydraulic connection at ○ and □
- with type 4 without hydraulic connection

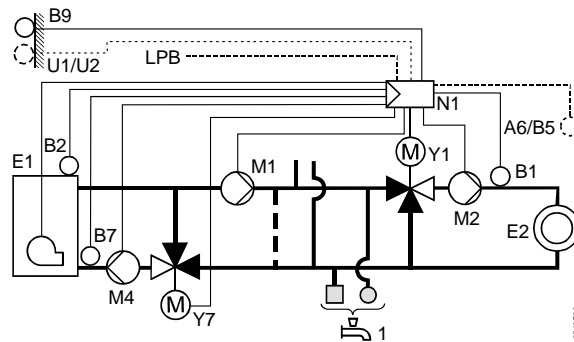

Heating circuit plant type 4

Precontrol with boiler

Precontrol with demand-dependent boiler temperature control, 2- or 3-position control acting on the burner.

Heat demand signal from data bus. No heating program.

Can be combined with d.h.w. types:

- with types 1, 2 and 3 via hydraulic connection at ○ and □
- with type 4 without hydraulic connection

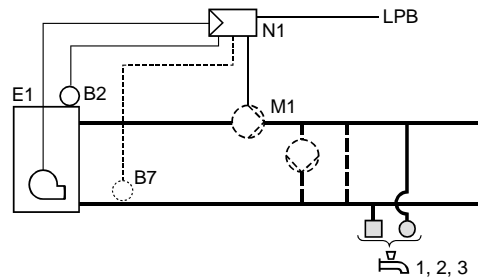

Heating circuit plant type 5

Precontrol with boiler, maintained boiler return temperature with mixing valve

Precontrol with demand-dependent boiler temperature control, 2- or 3-position control acting on the burner.

Heat demand signal from data bus. No heating program.

Minimum limitation of the return temperature with own mixing valve.

Can be combined with d.h.w. types:

- with type 1 via hydraulic connection at ○ and □
- with type 4 without hydraulic connection

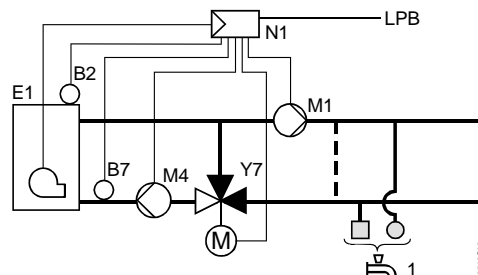

3.2.3 D.h.w. plant types

D.h.w. plant type 0

No d.h.w. heating

D.h.w. plant type 1

D.h.w. heating with charging pump

Charging of d.h.w. storage tank through control of the charging pump. Acquisition of the d.h.w. temperature with one or 2 sensors or thermostats. Circulating pump, solar collector and/or electric immersion heater are optional.

Note:

- Circulating pump M4 only with heating circuit plant types 1, 2 and 4
- Electric immersion heater not possible with modulating burner

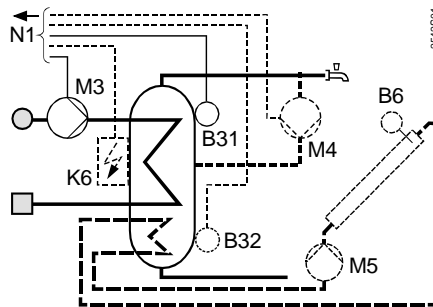

D.h.w. plant type 2

D.h.w. heating with mixing group

Charging of d.h.w. storage tank through control of the mixing valve according to own temperature sensor in the storage tank flow. Acquisition of the d.h.w. temperature with one or 2 sensors or thermostats. Circulating pump, solar collector and/or electric immersion heater are optional.

Note:

- Circulating pump M4 only with heating circuit plant types 1, 2 and 4
- Electric immersion heater not possible with modulating burner

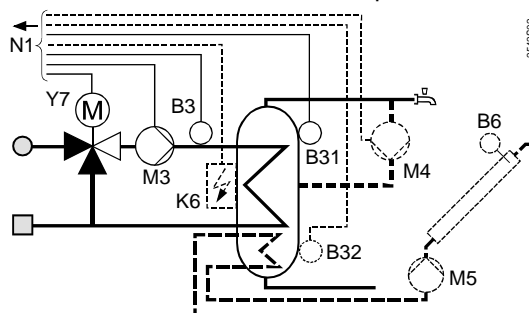

D.h.w. plant type 3

D.h.w. heating with heat exchanger

D.h.w. heating via heat exchanger (instantaneous d.h.w. heating) through control of the 2-port valve in the heat exchanger's primary return. Acquisition of the d.h.w. temperature in the heat exchanger's secondary flow. Circulating pump is optional.

Note:

- Circulating pump M4 only with heating circuit plant types 1, 2 and 4

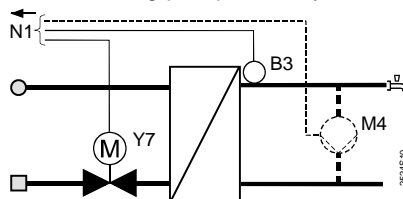

D.h.w. plant type 4

D.h.w. heating with electric immersion heater

Charging of d.h.w. storage tank only through release of the electric immersion heater. No control of d.h.w. heating by the controller. Circulating pump and solar collector are optional.

Note:

- Circulating pump M4 only with heating circuit plant types 1, 2 and 4
- Electric immersion heater not possible with modulating burner

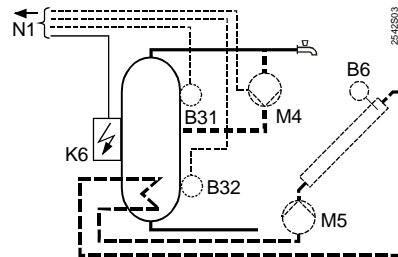

Note

With space heating types 2 through 4, the combination of heat source type “Modulating burner” and “D.h.w. plant type 4” is not permitted. This is indicated by an error message (error code 140).

- A6 Room unit
- B1 Flow sensor
- B2 Boiler sensor
- B3 D.h.w. flow sensor
- B31 Storage tank sensor / thermostat 1
- B32 Storage tank sensor / thermostat 2
- B5 Room sensor
- B6 Collector sensor
- B7 Return sensor
- B9 Outside sensor
- E1 Heat source (boiler)
- E2 Load (space)
- LPB Data bus
- K6 Electric immersion heater
- M1 Circulating pump / bypass pump
- M2 heating circuit pump
- M3 charging pump
- M4 Boiler pump / circulating pump
- M5 Collector pump
- N1 Controller RVL482
- U1 Solar sensor
- U2 Wind sensor
- Y1 Heating circuit mixing valve
- Y7 D.h.w. mixing valve or mixing valve for minimum limitation of the boiler return temperature

3.3 Setting levels, function blocks and plant types

Level	Function block	Plant combinations																				
		1-0	1-1	1-2	1-3	1-4	2-0	2-1	2-2	2-3	2-4	3-0	3-1	3-4	4-0	4-1	4-2	4-3	4-4	5-0	5-1	5-4
End-user	End-user space heating	•	•	•	•	•	•	•	•	•	•	•	•	•	•	•	•	•	•	•	•	•
	End-user d.h.w.	•	•	•	•	•	•	•	•	•	•	•	•	•	•	•	•	•	•	•	•	•
	End-user general	•	•	•	•	•	•	•	•	•	•	•	•	•	•	•	•	•	•	•	•	•
Heating engineer	Plant type	•	•	•	•	•	•	•	•	•	•	•	•	•	•	•	•	•	•	•	•	•
	Type of heat source	•	•	•	•	•	•	•	•	•	•	•	•	•	•	•	•	•	•	•	•	•
	Modulating boiler	•	•	•	•	•	•	•	•	•	•	•	•	•	•	•	•	•	•	•	•	•
	Cascade slave	•	•	•	•	•	•	•	•	•	•	•	•	•	•	•	•	•	•	•	•	•
	Space heating	•	•	•	•	•	•	•	•	•	•	•	•	•	•	•	•	•	•	•	•	•
	Three-position actuator heating circuit	•	•	•	•	•	•	•	•	•	•	•	•	•	•	•	•	•	•	•	•	•
	Boiler	•	•	•	•	•	•	•	•	•	•	•	•	•	•	•	•	•	•	•	•	•
	Pump M1	•	•	•	•	•	•	•	•	•	•	•	•	•	•	•	•	•	•	•	•	•
	Setpoint of return temperature limitation	•	•	•	•	•	•	•	•	•	•	•	•	•	•	•	•	•	•	•	•	•
	Type of return temperature limitation	•	•	•	•	•	•	•	•	•	•	•	•	•	•	•	•	•	•	•	•	•
	Bivalent maximum limitation of return temperature	•	•	•	•	•	•	•	•	•	•	•	•	•	•	•	•	•	•	•	•	•
	Three-position actuator mixing circuit	•	•	•	•	•	•	•	•	•	•	•	•	•	•	•	•	•	•	•	•	•
	Integral action time maximum limitation of return temp.	•	•	•	•	•	•	•	•	•	•	•	•	•	•	•	•	•	•	•	•	•
	Assignment of d.h.w.	•	•	•	•	•	•	•	•	•	•	•	•	•	•	•	•	•	•	•	•	•
	Circulating pump	•	•	•	•	•	•	•	•	•	•	•	•	•	•	•	•	•	•	•	•	•
Release, priority and flow temperature setpoint of d.h.w.	•	•	•	•	•	•	•	•	•	•	•	•	•	•	•	•	•	•	•	•	•	
D.h.w. storage tank	•	•	•	•	•	•	•	•	•	•	•	•	•	•	•	•	•	•	•	•	•	
Three-position actuator for d.h.w.	•	•	•	•	•	•	•	•	•	•	•	•	•	•	•	•	•	•	•	•	•	
Derivative action time d.h.w. heating via heat exchanger	•	•	•	•	•	•	•	•	•	•	•	•	•	•	•	•	•	•	•	•	•	
Multi-functional relay	•	•	•	•	•	•	•	•	•	•	•	•	•	•	•	•	•	•	•	•	•	
Legionella function	•	•	•	•	•	•	•	•	•	•	•	•	•	•	•	•	•	•	•	•	•	
Switching program 3	•	•	•	•	•	•	•	•	•	•	•	•	•	•	•	•	•	•	•	•	•	
Service functions and general settings	•	•	•	•	•	•	•	•	•	•	•	•	•	•	•	•	•	•	•	•	•	
Contact H2	•	•	•	•	•	•	•	•	•	•	•	•	•	•	•	•	•	•	•	•	•	
External inputs	•	•	•	•	•	•	•	•	•	•	•	•	•	•	•	•	•	•	•	•	•	
Solar d.h.w heating	•	•	•	•	•	•	•	•	•	•	•	•	•	•	•	•	•	•	•	•	•	
Locking functions	•	•	•	•	•	•	•	•	•	•	•	•	•	•	•	•	•	•	•	•	•	

2542T01

The above table shows

- The assignment of function blocks to the 3 operating levels
- The function blocks activated with the different plant types

3.4 Heating circuit operating modes

The heating circuit operating mode is selected on the controller by pressing the respective button. Also, the operating mode can be changed by bridging terminals H1–M.

3.4.1 Automatic operation

Auto 

- Automatic changeover from NORMAL to REDUCED temperature, and vice versa, according to the 7-day program entered
- Automatic changeover to holiday mode, and back, according to the holiday schedule entered
- Demand-dependent switching of the heating system according to the room and outside temperature while giving consideration to the building's thermal inertia (ECO function)
- Remote operation via room unit (optional)
- Frost protection is ensured

3.4.2 Continuously REDUCED heating



- Continuous heating to the REDUCED temperature
- With ECO function
- No holiday mode
- Remote operation from a room unit not possible
- Frost protection is ensured

3.4.3 Continuously NORMAL heating



- Continuous heating to NORMAL temperature
- No ECO function
- No holiday mode
- Remote operation from a room unit not possible
- Frost protection is ensured

3.4.4 Protection



- Heating is switched off, but is ready to operate
- Frost protection is ensured

3.5 D.h.w. operating modes



D.h.w. heating is switched on and off by pressing the respective button:

- ON (button  is lit): D.h.w. heating takes place independent of the heating circuit's operating mode and control. D.h.w. heating to the REDUCED or NORMAL setpoint is optional:

- According to the entered switching program 2
- According to the entered heating circuit program (–1 h)
- Continuously (24 hours a day)

During the entered holiday period, d.h.w. heating and the circulating pump are deactivated when using controllers with no bus connection (with data bus, depending on the setting made).

- OFF (button  dark): No d.h.w. Frost protection is ensured (except plant types x–4)

3.6 Manual operation



The RVL482 can be switched to manual operation. In that case, the control will be switched off.

In manual operation, the various actuating devices behave as follows:

- Heating circuit mixing valve: This mixing valve is active, but can be manually driven to any position by pressing the manual buttons (close) and (open). Heating circuit pump M2 is continuously running
- Boiler:
 - Plant types 1–x, 2–x, 3–x: Pump M2 is continuously running.
 - Single-stage burner: The first burner stage is continuously on
 - 2-stage burner: Both burner stages are continuously on
 - Modulating burner The basic stage is always on. Modulating burner operation is started
 - Plant types 4–x, 5–x: The circulating pump M1 is continuously running.
 - Single-stage burner: The burner stage is always on
 - 2-stage burner: The first burner stage is always on. The manual button can be used to switch the second stage on and off
 - Modulating burner: The basic stage is always on. Modulating burner operation off. Using the manual buttons (close) and (open), it can be driven to any position
- Charging pump: The charging pump is continuously running
- Collector pump: The collector pump is continuously running
- D.h.w. slipper / seat valve: This valve is driven to the fully closed position, in which case the closing time is five times the set running time. Then, it is deactivated
- Return circuit mixing valve: This mixing valve is driven to the fully closed position, in which case the opening time is 5 times the set running time. The boiler pump M4 is continuously running
- Circulating pump M4: This pump is continuously running
- Electric immersion heater K6: It is continuously released
- Multifunctional relay: Continuously energized
- Manual operation also negates any overriding of the controller's operating mode (bridging of H1–M).

3.7 Plant type and operating mode

Depending on the selected type of plant, the following operating modes are available:

Plant type	Operating mode					
	Auto					
1–0	YES	YES	YES	YES	NO	YES
1–1, 1–2, 1–3, 1–4	YES	YES	YES	YES	YES	YES
2–0	YES	YES	YES	YES	NO	YES
2–1, 2–2, 2–3, 2–4	YES	YES	YES	YES	YES	YES
3–0	YES	YES	YES	YES	NO	YES
3–1, 3–4	YES	YES	YES	YES	YES	YES
4–0	YES	NO	NO	*)	NO	YES
4–1, 4–2, 4–3, 4–4	YES	NO	NO	*)	YES	YES
5–0	YES	NO	NO	*)	NO	YES
5–1, 5–4	YES	NO	NO	*)	YES	YES

*) Depending on the boiler's operating mode (operating line 91):

- Boiler with manual shutdown: YES
- Boiler with automatic shutdown: NO
- Boiler without shutdown: NO

3.8 Operating state and operational level

The user selects the required heating circuit operating mode by pressing the respective button. Each operating mode has a maximum of 2 operating states – with the exception of operating mode "Continuously NORMAL heating" (only one operating state possible). When the ECO function is active, and in the case of quick setback, the operating state is always OFF.

When the operating state is ON, there is a maximum of 3 operational levels, depending on the operating mode. The operational level is determined by the heating program and the holiday program.

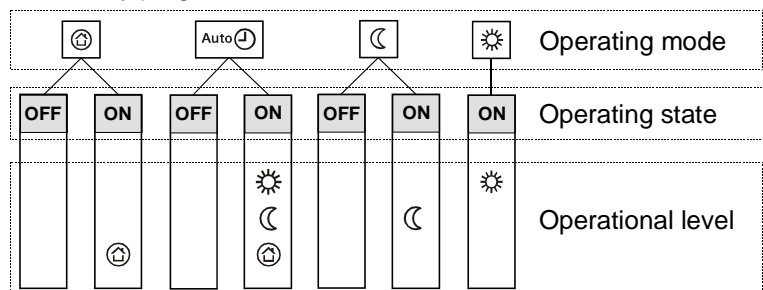

4 Acquisition of measured values

4.1 Room temperature (A6, B5)

4.1.1 Measurement

The following choices exist:

- A room temperature sensor QAA24 can be connected to terminal B5
- A room unit QAW50 or QAW70 can be connected to terminal A6
- 2 units can be connected to the terminals. In that case, the RVL482 can ascertain the average of the 2 measurements. The other room unit functions will not be affected by averaging

4.1.2 Handling faults

If there is a short-circuit or open-circuit in one of the 2 measuring circuits, the control responds as follows, depending on the room temperature source (setting on operating line 65):

- No sensor (operating line 65 = 0):
A short-circuit or open-circuit has no impact on the control. An error message will not be generated
- Room unit sensor QAW... (operating line 65 = 1):
In the event of a short-circuit or open-circuit, the control continues to operate with the room model, depending on the function. An error message will be generated
- Room temperature sensor QAA24 (operating line 65 = 2):
In the event of a short-circuit or open-circuit, the control continues to operate with the room model, depending on the function. An error message will be generated
- Average value (operating line 65 = 3):
In the event of a short-circuit or open-circuit in one of the 2 measuring circuits, the control continues to operate with the normally working measuring circuit. An error message will be generated
In the case of a short-circuit or open-circuit in both measuring circuits, the control continues to operate with the room model, depending on the function. 2 error messages will be generated
- Automatic mode (operating line 65 = A):
Since the controller itself decides how it acquires the room temperature, no error messages can be generated

4.1.3 Room model

The RVL482 features a room model. It simulates the progression of the room temperature. In plants with no acquisition of the room temperature, it can provide certain room functions (e.g. quick setback).

For more details, refer to section 12.4.4 "Room model temperature".

4.2 Flow temperature (B1)

4.2.1 Measurement

The flow temperature is required with plant types 1-x, 2-x and 3-x. It is acquired with one sensor LG-Ni 1000.

Averaging with 2 sensors is not possible.

4.2.2 Handling faults

A short-circuit or open-circuit in the measuring circuit is identified and indicated as a fault. In that case, the plant responds as follows:

- The circulating pump M2 continues to run
- The mixing valve will close

4.3 Boiler temperature (B2)

4.3.1 Measurement

The boiler temperature is required with plant types 2-x, 3-x, 4-x and 5-x. It is acquired with a sensor having a sensing element LG-Ni 1000.

4.3.2 Handling faults

A short-circuit or open-circuit in the measuring circuit is identified and indicated as a fault. In that case, the plant responds as follows:

- Plant types 2-x and 4-x:
 - The burner will shut down; with modulating burners, in addition, the damper actuator will be switched off
 - Pump M1 runs continuously
- Plant types 3-x and 5-x:
 - The burner will be shut down; with modulating burners, in addition, the damper actuator will be switched off
 - Pumps M1 and M4 will run continuously

4.4 Outside temperature (B9)

4.4.1 Measurement

The outside temperature is acquired with the outside sensor. This can be a QAC22 or QAC32:

- QAC22: Sensing element LG-Ni 1000
- QAC32: Sensing element NTC 575

The controller automatically identifies the type of sensor used.

In interconnected plants, the outside temperature signal is made available via LPB. Controllers having their own sensor pass the outside temperature signal to the data bus.

4.4.2 Handling faults

If there is a short-circuit or open-circuit in the measuring circuit, the controller responds as follows, depending on the outside temperature source:

- Controller not connected to the data bus (LPB):

The control operates with a fixed value of 0 °C outside temperature. An error message will be generated
- Controller connected to the data bus (LPB):

If the outside temperature is available via data bus, it will be used. An error message will not be generated (this is the normal status in interconnected plants!). If there is no outside temperature available on the data bus, however, the control uses a fixed value of 0 °C outside temperature. In that case, an error message will be generated

4.5 Return temperature (B7)

4.5.1 Measurement

The return temperature is acquired with a sensor having a sensing element LG-Ni 1000. This measured value is required for the minimum or maximum limitation of the return temperature.

In interconnected plants, the return temperature with plant type 1-x can be acquired via the data bus from the same segment. Controllers with plant type 1-x and connected sensor pass the return temperature signal of the common return to the data bus.

4.5.2 Handling faults

If there is a short-circuit or open-circuit in the measuring circuit, and if the controller requires the return temperature, it will respond as follows:

- Minimal limitation:
 - If there is a return temperature from a controller of the same segment available on the data bus, it is used (only with plant type 1-x). No error message will be generated since this is the normal status in interconnected plants. If, on the data bus, there is no return temperature available, the return temperature limitation functions will be deactivated and an error message generated
 - With plant types 3-x and 5-x, an error message will be generated. The controller continues to operate without limitation, that is, the mixing valve in the return opens fully and pump M4 will run
- Maximum limitation
 - Plant type 1-x with maximum limitation of the return temperature: An error message will be generated. The RVL482 continues to operate without limitation
 - With plant types 2-x and 4-x, an error message will be generated. The RVL482 continues to operate without limitation. (When using a bypass pump with control via B7, the pump will operate parallel to boiler stage 1 in the event of fault)

4.6 D.h.w. flow temperature (B3)

4.6.1 Measurement

The d.h.w. flow temperature is acquired with a sensor having a sensing element LG-Ni 1000.

4.6.2 Handling faults

If there is a short-circuit or open-circuit in the measuring circuit, the d.h.w. will no longer be heated. The charging pump is deactivated and the actuating device (slipper or seat valve) is shut. An error message will be generated.

4.7 D.h.w. storage tank temperature (B31, B32)

4.7.1 Measurement

The storage tank temperature can be acquired as follows:

- With one or 2 sensors having a sensing element LG-Ni 1000, or
- With one or 2 thermostats

This means that there are 2 measuring circuits available.

4.7.2 Handling faults

The controller's response to faults in the measuring circuits depends on the type of d.h.w. demand (setting on operating line 126):

- One d.h.w. storage tank temperature sensor (operating line 126 = 0 or 4):
In the event of a short-circuit or open-circuit in one of the 2 measuring circuits, the controller continues to work with the other measuring circuit, if possible. An error message will not be generated.
If no valid measured value is obtained from either of the measuring circuits, an error message will be generated. The d.h.w. will no longer be heated; the charging pump and the collector pump are deactivated.
Exception: With plant type x-2, the d.h.w. storage tank is always charged when sensor B3 (d.h.w. flow) works normally
- 2 d.h.w. storage tank temperature sensors (operating line 126 = 1 or 5):
In the event of a short-circuit or open-circuit in one of the 2 measuring circuits, the controller continues to work with the other measuring circuit. An error message will be generated.
If no valid measured value is obtained from either of the measuring circuits, 2 error messages will be generated. The d.h.w. will no longer be heated; the charging pump and the collector pump are deactivated.
Exception: With plant type x-2, the d.h.w. storage tank is always charged when sensor B3 (d.h.w. flow) works normally
- One d.h.w. storage tank thermostat (operating line 126 = 2):
If, in measuring circuit B31, there is neither an open-circuit (thermostat open) nor a short-circuit (thermostat closed), an error message will be generated. The d.h.w. will no longer be heated; the charging pump is deactivated.
Exception: With plant type x-2, the d.h.w. storage tank is always charged when sensor B3 (d.h.w. flow) works normally
- 2 d.h.w. storage tank thermostats (operating line 126 = 3):
If there is neither an open-circuit (thermostat open) nor a short-circuit (thermostat closed) in one of the measuring circuits, an error message will be generated. The controller continues to work with the measuring circuit that is intact.
If, in both measuring circuits, there is neither an open-circuit (thermostat open) nor a short-circuit (thermostat closed), 2 error messages will be generated. The d.h.w. will no longer be heated; the charging pump is deactivated.
Exception: With plant type x-2, the d.h.w. storage tank is always charged when sensor B3 (d.h.w. flow) works normally

4.8 Collector temperature (B6)

4.8.1 Measurement

The collector temperature is acquired via a sensor with sensing element LG-Ni 1000 and an extended measuring range.

4.8.2 Handling faults

An error message is generated and the collector pump deactivated with a delay of 12 hours in case of a short-circuit or open-circuit in the measuring circuit. There is no solar d.h.w. heating.

4.9 Solar sensor (U1)

4.9.1 Measurement

Solar radiation is acquired with a solar sensor. The level of solar radiation is delivered in the form of a DC 0...10 V signal; this voltage range corresponds to 0...1000 W/m². In interconnected plants, the solar signal is made available via LPB. Controllers having their own sensor pass the solar signal to the data bus.

4.9.2 Handling faults

An error message will be generated when, with solar influence selected (greater than 0), the sensor value is not available on the data bus and no local sensor is used. Open-circuit or short-circuit of the own sensor cannot be detected.

4.10 Wind sensor (U2)

4.10.1 Measurement

The wind speed is acquired with a wind sensor. It is delivered in the form of a DC 0...10 V signal; this voltage range corresponds to a wind speed of 0...20 m/s (0...72 km/h).

In interconnected plants, the wind signal is made available via LPB. Controllers having their own sensor pass the wind signal to the data bus.

4.10.2 Handling faults

An error message will be generated when, with wind influence selected (greater than 0), the sensor value is not available on the data bus and no load sensor is used. Open-circuit or short-circuit of the own sensor cannot be detected.

5 Function block "Enduser space heating"

This function block contains settings that the enduser himself can make.

5.1 Operating lines

Line	Function, parameter	Factory setting (range)	Unit
1	Setpoint of NORMAL heating	20.0 (0...35)	°C
2	Setpoint of REDUCED heating	14.0 (0...35)	°C
3	Setpoint of holiday mode / frost protection	10.0 (0...35)	°C
4	Weekday for the heating program	1-7 (1...7 / 1-7)	
5	First heating period, start of NORMAL heating	06:00 (00:00...24:00)	hh:mm
6	First heating period, start of REDUCED heating	22:00 (00:00...24:00)	hh:mm
7	Second heating period, start of NORMAL heating	--:-- (00:00...24:00)	hh:mm
8	Second heating period, start of REDUCED heating	--:-- (00:00...24:00)	hh:mm
9	Third heating period, start of NORMAL heating	--:-- (00:00...24:00)	hh:mm
10	Third heating period, start of REDUCED heating	--:-- (00:00...24:00)	hh:mm
11	Holiday period	- (1...8)	
12	Date of first day of holiday	--:-- (01.01...31.12)	dd:MM
13	Date of last day of holiday	--:-- (01.01...31.12)	dd:MM
14	Heating curve, flow temperature setpoint at an outside temperature of 15 °C	30 (20...70)	°C
15	Heating curve, flow temperature setpoint at an outside temperature of -5 °C	60 (20...120)	°C

5.2 Setpoints

5.2.1 General

The setpoints of the NORMAL and the REDUCED room temperature and of frost protection for the plant / holiday mode are entered directly in °C room temperature. They are independent of whether or not the control uses a room temperature sensor.

5.2.2 Frost protection for the building

The lowest valid room temperature setpoint always corresponds to at least the setpoint of holiday mode / frost protection (setting on operating line 3), even if lower values have been entered as the setpoints of the NORMAL and the REDUCED room temperature (settings on operating lines 1 and 2).

If a room sensor is used and the room temperature falls below the holiday/frost protection setpoint, ECO – if available – will stop OFF until the room temperature has risen 1 °C above the holiday / frost protection setpoint.

5.3 Heating program

The heating program of the RVL482 provides a maximum of 3 heating periods per day; also, every weekday can have different heating periods.

Note

The entries to be made are not the switching times, but the periods of time during which the NORMAL room temperature shall apply. Usually, these periods of time are identical to the building's occupancy schedule. The actual switching times for the change from the REDUCED to the NORMAL room temperature, and vice versa, are calculated by the optimization function. (Pre-condition: Optimization is activated).

Using the setting "1-7" on operating line 4, it is possible to enter a heating program that applies to all days of the week. This simplifies the settings. If the weekend times differ, enter the times for the entire week first, and then change days 6 and 7 as required.

The settings are sorted and overlapping heating periods combined.

5.4 Holiday program

A maximum of 8 holiday periods per year can be programmed. At 00:00 of the first day of the holiday period, changeover to the setpoint for frost protection/holiday mode takes place. At 24:00 of the last day of the holiday period, the RVL482 will change to NORMAL or REDUCED heating in accordance with the time switch settings.

The settings of each holiday period will be cleared as soon as the respective period has elapsed.

Holiday periods may overlap. It is not necessary to observe a certain order. Depending on the entry made on operating line 121, the holiday function will switch off d.h.w. heating and the circulating pump.

The holiday program is only active in **Auto**  mode.

6 Function block "Enduser d.h.w."

This function block contains settings for d.h.w. heating that the enduser himself can make.

6.1 Operating lines

<i>Line</i>	<i>Function, parameter</i>	<i>Factory setting (Range)</i>	<i>Unit</i>
26	Setpoint of NORMAL d.h.w. temperature	55 (20...100)	°C
27	D.h.w. temperature	Display function	
28	Setpoint of REDUCED d.h.w. temperature	40 (8...80)	°C

6.2 Setpoint

The NORMAL and REDUCED setpoints of the d.h.w. temperature are to be entered in °C. When using thermostats, it must be made certain that the NORMAL setpoint entered here agrees with the setpoint of the thermostat or – if 2 thermostats are used – of both thermostats. If there is a differential, the charging temperature cannot be correctly calculated (charging temperature = NORMAL setpoint [operating line 26] + boost of charging temperature [operating line 127]).

If d.h.w. heating is switched to the electric immersion heater, the setpoint adjustment is inactive in that case, since the thermostat of the electric immersion heater will ensure temperature control of the storage tank.

6.3 Actual value

The d.h.w. temperature is displayed in °C as follows, depending on the type of plant:
Plant type.

<i>Plant type</i>	<i>Display</i>
x-0, x-4	No display
x-1, x-2	Measured value of storage tank sensor B31 or maximum selection of the 2 storage tank sensors B31 and B32
x-3	Measured value of d.h.w. flow temperature sensor B3

If the measurement is made with one or 2 thermostats, it is not possible to display the actual value. In that case, the display shows ---.

7 Function block "Enduser general"

This function block contains settings that the enduser himself can make, as well as indication of faults.

7.1 Operating lines

<i>Line</i>	<i>Function, parameter</i>	<i>Factory setting (range)</i>	<i>Unit</i>
31	Weekday for switching program 2	1-7 (1...7 / 1-7)	
32	Start of first ON period	05:00 (--:-- / 00:00...24:00)	hh:mm
33	End of first ON period	22:00 (--:-- / 00:00...24:00)	hh:mm
34	Start of second ON period	--:-- (--:-- / 00:00...24:00)	hh:mm
35	End of second ON period	--:-- (--:-- / 00:00...24:00)	hh:mm
36	Start of third ON period	--:-- (--:-- / 00:00...24:00)	hh:mm
37	End of third ON period	--:-- (--:-- / 00:00...24:00)	hh:mm
38	Time of day	00:00...23:59	hh:mm
39	Weekday	Display function	
40	Date	(01.01...31.12)	dd:MM
41	Year	(1995...2094)	jjjj
50	Indication of errors	Display function	

7.2 Switching program 2

Switching program 2 can be used for one or several of the following functions:

- As a time switch program for the circulating pump
- As a time switch program for the release of d.h.w. heating
- As a time switch program for the multifunctional relay

Switching program 2 of the RVL482 affords up to 3 ON periods per day. Also, every weekday may have different ON periods.

As with the heating program, it is not the "switching times" that are to be entered, but the periods of time during which the program or the controlled function shall be active. Using setting "1-7" on operating line 31, it is possible to enter a switching program that applies to all days of the week. This simplifies the settings: if the weekend times are different, first enter the times for the entire week, then change days 6 and 7 as required.

The entries are sorted and overlapping ON periods combined.

7.3 Time of day and date

The RVL482 has a yearly clock to enter the time of day and the date.

The weekday on line 39 is set automatically with the date and cannot be adjusted.

The changeover from summer- to wintertime, and vice versa, takes place automatically. Should the respective regulations change, the changeover dates can be adjusted (refer to chapter "30 Function block "Service functions and general settings"").

7.4 Indication of errors

The following errors are indicated:

Number	Fault
10	Fault outside sensor
11	Fault solar sensor
12	Fault wind sensor
20	Fault boiler temperature sensor
30	Fault flow temperature sensor
40	Fault return temperature sensor (primary circuit)
50	Fault storage tank temperature sensor/control thermostat 1
52	Fault storage tank temperature sensor/control thermostat 2
54	Fault d.h.w. flow temperature sensor
60	Fault room temperature sensor
61	Fault room unit
62	Wrong room unit connected
73	Fault collector sensor
81	Short-circuit on the bus (LPB)
82	Same bus address assigned several times
100	Two clock masters on the bus (LPB)
120	Flow alarm
140	Inadmissible bus address (LPB) or plant type

If a fault occurs, the LCD displays .

In interconnected plants, the address (device and segment number) of the controller causing the fault is indicated on all the other controllers. No address will appear on the controller causing the fault.

Example of display in interconnected plants:

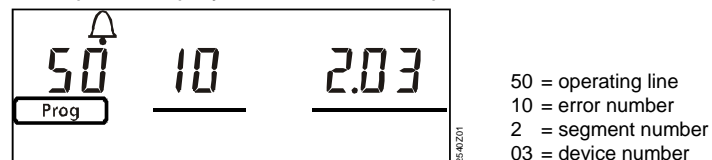

The error message disappears only after rectification of the fault. There will be no acknowledgement!

8 Function block "Plant type"

This function block contains the selection of the plant type.

8.1 Operating line

Line	Function, parameter	Factory setting (range)	Unit
51	Plant type	2-1 (1-0...5-4)	

8.2 General

When commissioning the plant, the respective plant type must be entered first. This ensures that the functions required for the specific type of plant, the parameters and operating lines for the settings and displays will be activated.

All plant-specific variables and operating lines for the other plant types will then be dead.

Example of an entry (selection of plant type 1-2)

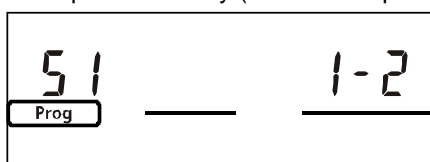

- 51 = operating line
- 1 = heating circuit plant type 1
- 2 = d.h.w. circuit type 2

9 Function block "Type of heat source"

This function block contains the selection of the type of heat source which is important for direct burner control.

9.1 Operating line

<i>Line</i>	<i>Function, parameter</i>	<i>Factory setting (range)</i>	<i>Unit</i>
54	Type of heat source	2 (1...3)	

9.2 Setting

When commissioning the installation, the relevant type of heat source must be selected.

<i>Operating line 54</i>	<i>Type of heat source</i>
1	Single-stage burner: Boiler temperature control as 2-position control
2	2-stage burner: Boiler temperature control as 2-position control
3	Modulating burner: Boiler temperature control between basic load and full load is modulating

10 Function block "Modulating burner"

On this function block, the control parameters of boiler temperature control for the modulating burner can be set.

10.1 Operating lines

Line	Function, parameter	Factory setting (range)	Unit
55	Running time of damper actuator	60 (7.5...480)	s
56	P-band of modulating control (Xp)	20 (1...200)	°C
57	Integral action time of modulating control (Tn)	150 (10...500)	s
58	Derivative action time of modulating control (Tv)	4.5 (0...30)	s

Note

It must be observed that the running time to be set only refers to the modulating range.

Example

Running time of damper actuator (90°) = 120 s

Minimum position of damper actuator = 20°

Maximum position of damper actuator = 80°

Hence, the running time t of the damper actuator effective for the control is as follows:

$$t = \frac{120 \text{ s} \times (80^\circ - 20^\circ)}{90^\circ} = 80 \text{ s}$$

10.2 Description

Normally, modulating burners operate in modulating mode only above a certain limit (for normal forced draft burners, this limit is about 30 to 40 % of the rated capacity). When demand for heat is small, the RVL482 switches the basic stage on/off (terminal K4).

When demand for heat increases, the RVL482 delivers a 3-position signal (terminals K5 and K6), which controls the combustion air damper.

At the same time, the amount of fuel supplied will also be increased, typically by an additional switch on the air damper, or by simultaneous control of the amount of fuel (air/fuel ratio control).

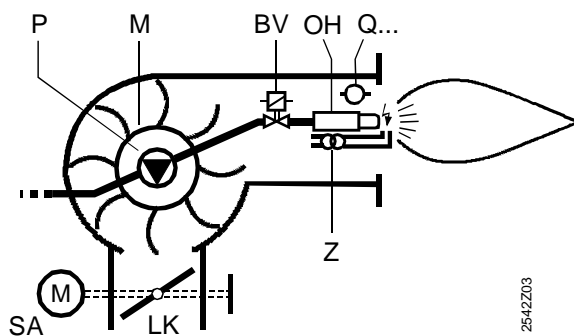

- M Fan
- P Oil pump, coupled to fan motor
- BV Fuel valve(s)
- Z Ignition transformer
- LK Combustion air damper, fixed or motorized
- SA Air damper actuator
- Q... Flame detector
- OH Oil preheater; located between nozzle and adjustable head with small light-oil burners, separate unit with large heavy-oil burners

10.3 Control

The control is described in section "14.5 Control with a modulating burner".

11 Function block "Cascade slave"

This function block enables the controller to be integrated in a heat source cascade as a cascade slave. A heat source cascade is the combination of several oil- / gas-fired boilers.

11.1 Operating lines

Line	Function, parameter	Factory setting (range)	Unit
59	Release integral for boiler sequence	200 (0...500)	°Cxmin
60	Reset integral of boiler sequence	50 (0...500)	°Cxmin

11.2 Mode of operation

The surplus heat or the heat deficit of the boiler is ascertained with the boiler sequence integral and delivered to the cascade master via LPB.

11.2.1 Release integral (KFI) for boiler sequence

The release integral for the boiler sequence is a variable generated from the progression of the cascade flow temperature and time. When the set value is exceeded, a heat deficit signal will be transmitted to the cascade master.

$$KFI = \int_0^t \Delta T dt \quad \text{where: } \Delta T = (T_{VKw} - 0,5 \times SD - T_{VKx}) > 0$$

SD Switching differential of the boiler
t Time
 T_{VKw} Flow temperature setpoint of the cascade
 T_{VKx} Actual value of cascade flow temperature

11.2.2 Reset integral (KRI) for the boiler sequence

The reset integral for the boiler sequence is a variable generated from the progression of the cascade flow temperature and time. When the set value is exceeded, a surplus heat signal will be transmitted to the cascade master.

$$KRI = \int_0^t \Delta T dt \quad \text{where: } \Delta T = (T_{VKx} - T_{VKw} + 0.5 \times SD) > 0$$

Note

Automatic boiler sequence changeover based on the number of burner hours run is not possible with the RVL482 since this controller does not acquire the number of burner operating hours.

12 Function block "Space heating"

This function block performs the ECO function, the optimization functions with boost heating and quick setback, as well as the room influence.

12.1 Operating lines

Line	Function, parameter	Factory setting (range)	Unit
61	Heating limit for NORMAL heating (ECO day)	17.0 (-.- / -5.0...+25.0)	°C
62	Heating limit for REDUCED heating (ECO night)	5.0 (-.- / -5.0...+25.0)	°C
63	Building time constant	20 (0...50)	h
64	Quick setback	1 (0 / 1)	
65	Room temperature source	A (0 / 1 / 2 / 3 / A)	
66	Type of optimization	0 (0 / 1)	
67	Maximum heating up time	00:00 (00:00...42:00)	hh:mm
68	Maximum early shutdown	0:00 (0:00...6:00)	h:mm
69	Maximum limitation of the room temperature	--.- (-.- / 0...35)	°C
70	Gain factor of room influence	4 (0...20)	
71	Boost of room temperature setpoint	5 (0...20)	°C
72	Parallel displacement of the heating curve	0.0 (-4.5...+4.5)	°C
73	Type of adjustment of heating curve slope	0 (0...2)	

12.2 ECO function

The ECO function controls space heating depending on demand. It gives consideration to the progression of the room temperature depending on the type of building construction as the outside temperature varies. If the amount of heat stored in the house or building is sufficient to maintain the room temperature setpoint currently required, the ECO function will switch the heating off.

When using the ECO function, the heating system operates only, or consumes energy only, when required.

12.2.1 Compensating variables and auxiliary variables

As compensating and auxiliary variables, the ECO function takes into account the development of the outside temperature and the heat storage capacity of the building. The following variables are taken into consideration:

- The building time constant: this is a measure of the type of building construction and indicates how quickly the room temperature would change if the outside temperature was suddenly changed. The following guide values can be used for setting the building time constant:
 - 10 h for light building structures
 - 25 h for medium building structures
 - 50 h for heavy building structures
- The actual outside temperature (T_A)
- The composite outside temperature (T_{AM}), which is the mean value of:
 - the actual outside temperature, and
 - the outside temperature filtered by the building time constantCompared with the actual outside temperature, the composite outside temperature is attenuated. Hence, it represents the effects of short-time outside temperature variations on the room temperature as they often occur during intermediate seasons (spring and autumn)
- The attenuated outside temperature (T_{AD}): it is generated by filtering twice the actual outside temperature by the building time constant. This means that, compared with the actual outside temperature, the attenuated outside temperature is considerably dampened. This ensures that no heating will take place in the summer when, under normal circumstances, the heating would be switched on because the outside temperature drops for a few days

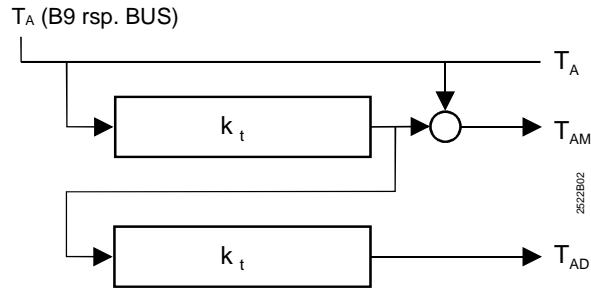

Generation of the composite and attenuated outside temperature

T_A Actual outside temperature
 T_{AD} Attenuated outside temperature
 T_{AM} Composite outside temperature
 k_t Building time constant

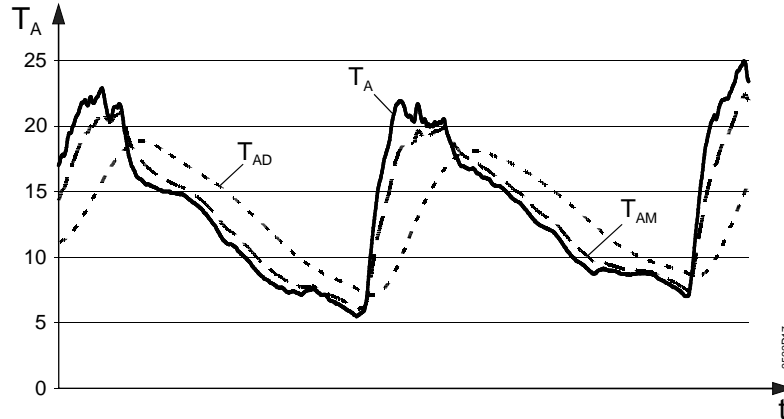

Progression of the actual, composite and attenuated outside temperature

T_A Actual outside temperature
 T_{AD} Attenuated outside temperature
 T_{AM} Composite outside temperature
 t Time

12.2.2 Heating limits

The following heating limits can be set:

- "ECO day" for NORMAL heating
- "ECO night" for the lower temperature level. This can be REDUCED heating or OFF (holidays / frost protection)

In both cases, the heating limit is the outside temperature at which the heating shall be switched on and off. The switching differential is 1 °C.

If the effect of wind is taken into consideration, the ECO heating limits will change depending on the wind speed.

12.2.3 Mode of operation

Switching the heating off

The heating will be switched off when **one** of the 3 following conditions is satisfied:

- The actual outside temperature exceeds the current ECO heating limit
- The composite outside temperature exceeds the current ECO heating limit
- The attenuated outside temperature exceeds the "ECO day" heating limit

In all these cases, it is assumed that the amount of heat entering the building envelope from outside or the amount of heat stored in the building structure will be sufficient to maintain the required room temperature level.

When the ECO function has switched the heating off, the display shows **ECO**.





Switching the heating on

The heating will be switched on again only when **all** 3 of the following conditions are satisfied:

- The actual outside temperature has fallen 1 °C below the current ECO heating limit
- The composite outside temperature has fallen 1 °C below the current ECO heating limit
- The attenuated outside temperature has fallen 1 °C below the "ECO day" heating limit

Operating modes and operating statuses

The ECO function is performed depending on the operating mode:

<i>Operating mode or operational status</i>	<i>ECO function</i>	<i>Current heating limit</i>
Auto  Automatic operation	active	ECO day or ECO night
 Continuously REDUCED heating	active	ECO night
 Continuously NORMAL heating	inactive	–
 Protection mode / holiday mode	active	ECO night
 Manual operation	inactive	–

12.3 Room temperature source

The outside temperature source can be selected on operating line 65.

The following settings are available:

<i>Operating line 65 SET</i>	<i>Room temperature source</i>
0	No room sensor
1	Room unit connected to terminal A6
2	Room sensor connected to terminal B5
3	Average value of devices connected to terminals A6 and B5
A	Automatic selection

On operating line 65, the room temperature source actually used by the controller will also be displayed (ACTUAL).

ACTUAL = 0 = Controller operates without a sensor

ACTUAL = 1: Controller operates with a room unit connected to terminal A6

ACTUAL = 2: Controller operates with a room sensor connected to terminal B5

ACTUAL = 3: Controller operates with the average value of the devices connected to terminals A6 and B5

12.4 Optimization

12.4.1 Definition and purpose

Operation of the heating system is optimized. According to EN 12 098, optimization is the "automatic shifting of the switch-on and switch-off points aimed at saving energy".

This means that:

- Switching on and heating up as well as switching off are controlled such that during building occupancy times the required room temperature level will always be ensured
- The smallest possible amounts of energy will be used to achieve this objective

12.4.2 Fundamentals

It is possible to select or set:

- The type of optimization: Either with a room sensor / room unit or based on the room model
- The maximum limit value for the heating-up time
- The maximum limit value for optimum shut-down
- Quick setback: yes or no

To perform the optimization function, the controller makes use of the actual room temperature – acquired by a room temperature sensor or room unit – or the room model.

With room sensor

Using a room sensor or room unit, it is possible to have optimum start **and** optimum stop control.

To be able to optimally determine the switch-on and switch-off points, optimization needs to "know" the building's heating up and cooling down characteristics, always as a function of the prevailing outside temperature. For this purpose, optimization continually acquires the room temperature and the outside temperature. It captures these variables via the room sensor and the outside sensor and continually adjusts the forward shift of the switching points. In this ways, optimization can also detect changes made to the house or building and to take them into consideration.

The learning process always concentrates on the first heating period per day.

Without room sensor

When no room sensor is used, the room model **only** allows optimum start control.

Optimization operates with fixed values (no learning process), based on the set maximum heating up time and the room model.

12.4.3 Process

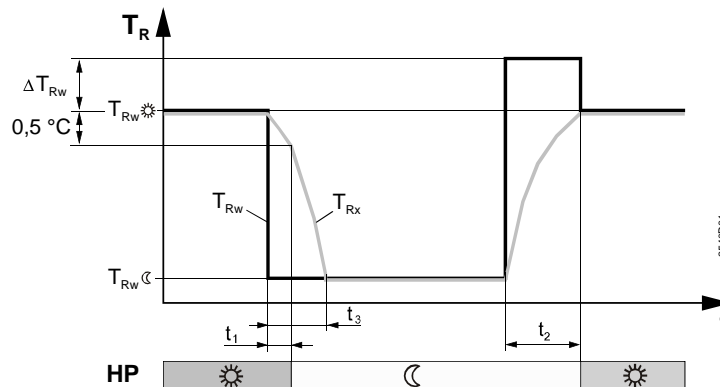

HP	Heating program
T_R	Room temperature
t	Time
t_1	Forward shift for early shutdown
t_2	Forward shift for the start of heating up
t_3	Quick setback
T_{Rw}	Room temperature setpoint
T_{Rw}^*	Setpoint of NORMAL room temperature
T_{Rw}	Setpoint of REDUCED room temperature
ΔT_{Rw}	Boost of room temperature setpoint (with boost heating)
T_{Rx}	Actual value of the room temperature

12.4.4 Room model temperature

To ascertain the room temperature generated by the room model, a distinction must be made between 2 cases:

- The RVL482 is not in quick setback mode:
The room temperature generated by the room model is identical to the current room temperature setpoint
- The RVL482 is in setback mode:
The room temperature generated by the room model is determined according to the following formula:

$$\text{Room model temperature } T_{RM} = (T_{Rw}^* - T_{AM}) \times e^{-\frac{t}{3 \times kt}} + T_{AM} \text{ [}^\circ\text{C]}$$

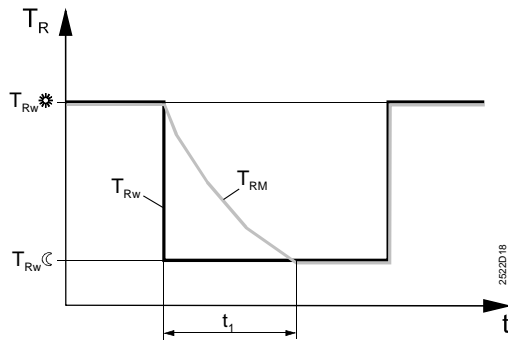

Progression of the room temperature generated by the room model

e	2.71828 (basis of natural logarithms)	T_R	Room temperature
kt	Building time constant in hours	T_{RM}	Room model temperature
t	Time in hours	T_{Rw*}	Setpoint of NORMAL room temperature
t_1	Quick setback	T_{RwC}	Setpoint of REDUCED room temperature
T_{AM}	Composite outside temperature		

12.4.5 Optimum stop control

During the building's occupancy time, the RVL482 maintains the setpoint of NORMAL heating. Towards the end of the occupancy time, the control switches to the REDUCED setpoint. Optimization calculates the changeover time such that, at the end of occupancy, the room temperature will be 0.5 °C below the setpoint of NORMAL heating (optimum shutdown).

By entering 0 hours as the maximum optimum shutdown, optimum stop control can be deactivated.

12.4.6 Quick setback

When changing from the NORMAL temperature to a lower temperature level (REDUCED or holidays / frost), the heating will be shut down. And it will remain shut down until the setpoint of the lower temperature level is reached.

- When using a room sensor, the effective actual value of the room temperature is taken into account
- When using no room sensor, the actual value is simulated by the room model

The duration is determined according to the following formula

$$t = 3 \times kt \times \left(\ln \frac{T_{RwC} - T_{AM}}{T_{Rw*} - T_{AM}} \right) \text{ [h]}$$

ln	Natural logarithm
k_t	Building time constant in h
t	Duration of quick setback
T_{AM}	Composite outside temperature
T_{Rw*}	Setpoint of NORMAL room temperature
T_{RwC}	Setpoint of REDUCED room temperature

12.4.7 Optimum start control

During the building's non-occupancy times, the RVL482 maintains the setpoint of REDUCED heating. Toward the end of the non-occupancy time, optimization switches the control to boost heating. This means that the selected boost will be added to the room temperature setpoint. Optimization calculates the changeover time such that, at the start of occupancy, the room temperature will have reached the setpoint of NORMAL heating.

When the room temperature is simulated by the room model, that is, when using no room sensor, the forward shift in time is calculated as follows:

$$t = (T_{Rw*} - T_{RM}) \cdot 3 \times kt \text{ [min]}$$

kt	Building time constant in h
t	Forward shift
T_{Rw*}	Setpoint of NORMAL room temperature
T_{RM}	Room model temperature

Optimum start control with the room model takes place only if, previously, quick setback took place.

Optimum start control can be deactivated by entering 0 hours as the maximum heating up period.

12.4.8 Boost heating

For boost heating, a room temperature setpoint boost can be set.

After changeover to the NORMAL temperature, the higher room temperature setpoint applies, resulting in an appropriately higher flow temperature setpoint.

D.h.w. heating during boost heating does not affect the latter.

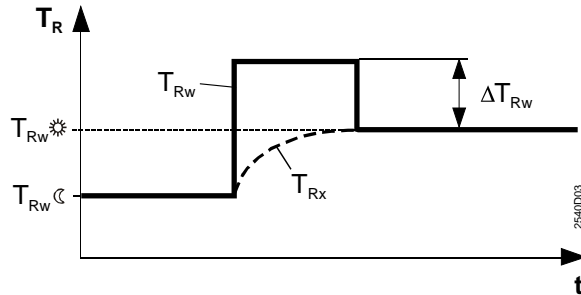

t	Time	T_{Rx}	Actual value of the room temperature
T_R	Room temperature	T_{Rw}	Room temperature setpoint
T_{Rw}^*	Setpoint of NORMAL room temperature	ΔT_{Rw}	Boost of room temperature setpoint (with boost heating)
T_{Rw}^{ζ}	Setpoint of REDUCED room temperature		

Duration of boost

- When using a room sensor, boost heating is maintained until the room temperature has reached the setpoint of NORMAL heating. Then, that setpoint will be used again
- When using no room sensor, the room model calculates how long boost heating will be maintained.

The duration is determined according to the following formula:

$$t_1 = 2 \times \frac{T_{Rw}^* - T_{RM1}}{T_{Rw}^* - T_{Rw}^{\zeta}} \times \frac{kt}{20} \quad [\text{h}]$$

The duration of the boost is limited to 2 hours.

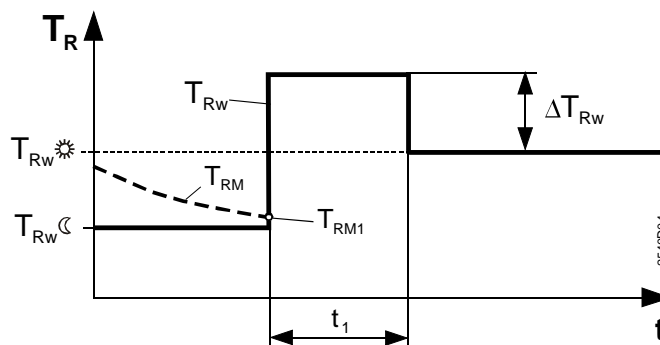

k_t	Building time constant in hours	T_{Rw}^{ζ}	Setpoint of REDUCED room temperature
t	Time	T_{RM}	Room model temperature
t_1	Duration of room temperature setpoint boost	T_{RM1}	Room model temperature at the beginning of boost heating
	Boost heating	T_{Rw}	Room temperature setpoint
T_R	Room temperature	ΔT_{Rw}	Boost of room temperature setpoint (with boost heating)
T_{Rw}^*	Setpoint of NORMAL room temperature		

12.5 Room functions

12.5.1 Maximum limitation of the room temperature

For the room temperature, it is possible to have an adjustable maximum limitation. For that purpose, a room sensor is required (sensor or room unit).

If the room temperature lies 1 °C above the limit value, the room temperature setpoint will be lowered by 4 °C.

Maximum limitation of the room temperature is independent of the setting used for the room influence.

If the room temperature lies above the limit value, the display shows f .

The reduction of the flow temperature setpoint ΔT_{Vw} is calculated as follows:

$$\Delta T_{Vw} = \Delta T_{Rw} \times (1 + s) \quad [\text{K}]$$

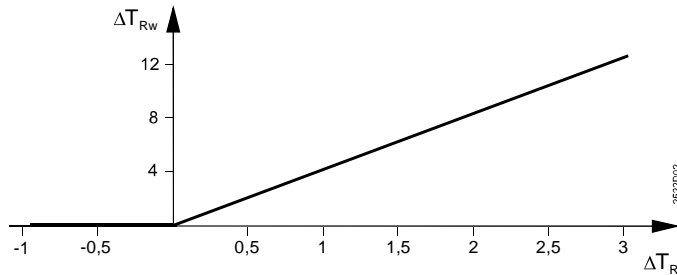

s	Heating curve slope
ΔT_{Rw}	Reduction of the room temperature setpoint
ΔT_R	Deviation of the room temperature
ΔT_{Vw}	Reduction of the flow temperature setpoint

12.5.2 Room influence

The room temperature is included in the control process. For that purpose, a room sensor is required (sensor or room unit).

The gain factor of the room temperature influence on the flow temperature control can be adjusted. This indicates to what extent deviations of the actual room temperature from the setpoint have an impact on the flow temperature control:

0 = room temperature deviations have no impact on the generation of the setpoint

20 = room temperature deviations have a maximum impact on the generation of the setpoint.

The change of the room temperature setpoint ΔT_{Rw} is calculated according to the following formula:

$$\Delta T_{Rw} = \frac{VF}{2} \times (T_{Rw} - T_{Rx}) \quad [\text{K}]$$

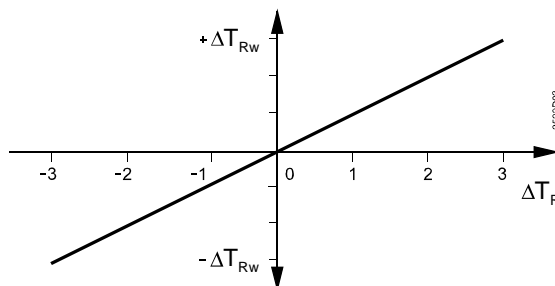

The change of the flow temperature setpoint ΔT_{Vw} resulting from the change of the room temperature setpoint is calculated as follows:

$$\Delta T_{Vw} = \Delta T_{Rw} \times (1 + s) \quad [\text{K}]$$

s	Heating curve slope	T_{Rx}	Actual value of the room temperature
T_{Rw}	Room temperature setpoint	ΔT_R	Room temperature deviation ($T_{Rw} - T_{Rx}$)
ΔT_{Rw}	Change of room temperature setpoint	ΔT_{Vw}	Change of flow temperature setpoint
$-\Delta T_{Rw}$	Decrease of room temperature setpoint	VF	Gain factor
$+\Delta T_{Rw}$	Increase of room temperature setpoint		

12.6 Heating curve

12.6.1 Purpose

With the space heating systems (plant types 1–x, 2–x, and 3–x), flow temperature control is always weather-compensated. The assignment of the flow temperature setpoint to the prevailing outside temperature is made via the heating curve.

12.6.2 Basic setting

The heating curve is adjusted with the little bar, or via 2 operating lines. The following settings are required:

- Flow temperature setpoint at an outside temperature of $-5\text{ }^{\circ}\text{C}$
- Flow temperature setpoint at an outside temperature of $+15\text{ }^{\circ}\text{C}$

The basic setting during commissioning is made according to the planning documentation or in agreement with local practices.

Adjustment with the little bar

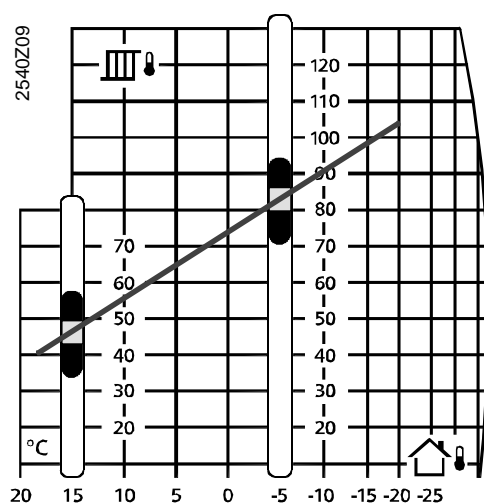

Adjustment via the operating lines

The adjustment is made via operating lines 14 and 15.

Operating line	Setpoint
14	TV1, flow temperature setpoint at an outside temperature of $+15\text{ }^{\circ}\text{C}$
15	TV2, flow temperature setpoint at an outside temperature of $-5\text{ }^{\circ}\text{C}$

Selection of adjustment

The type of adjustment can be selected on operating line 73.

Operating line 73	Bar	Operating line 14	Operating line 15
0	Active	Inactive	Inactive
1	Inactive	Active	Active
2	Inactive	Only display function, re-adjustment only via LPB	Only display function, re-adjustment only via LPB

12.6.3 Deflection

The heat losses of a building are proportional to the difference between room temperature and outside temperature. By contrast, the heat output of radiators does not increase proportionally when the difference between radiator and room temperature increases. For this reason, the radiators' heat exchanger characteristic is deflected. The heating curve's deflection takes these properties into consideration.

In the range of small slopes (e.g. with underfloor heating systems), the heating curve is practically linear – due to the small flow temperature range – and therefore corresponds to the characteristic of low temperature heating systems.

Slope "s" is determined according to the following formula:

$$s = \frac{T_{Vw(-5)} - T_{Vw(+15)}}{20 \text{ K}}$$

s Heating curve slope

$T_{Vw(-5)}$ Flow temperature setpoint at an outside temperature of $-5 \text{ }^\circ\text{C}$

$T_{Vw(+15)}$ Flow temperature setpoint at an outside temperature of $+15 \text{ }^\circ\text{C}$

On the controller, the heating curve is shown as a straight line. This straight line corresponds exactly to the deflected heating curve, because the nonlinear outside temperature scale corresponds to the deflection.

The heating curve is valid for a room temperature setpoint of $20 \text{ }^\circ\text{C}$.

12.6.4 Parallel displacement of the heating curve

The heating curve can be displaced parallel:

- Manually with the setting knob for room temperature readjustments. The readjustment can be made by the enduser and covers a maximum range of $-4.5 \dots +4.5 \text{ }^\circ\text{C}$ room temperature
- Manually on operating line 72

The parallel displacement of the heating curve is calculated as follows:

$$\text{Parallel displacement } \Delta T_{\text{Flow}} = (\Delta T_{\text{Knob}} + \Delta T_{\text{Operating line 72}}) \times (1 + s)$$

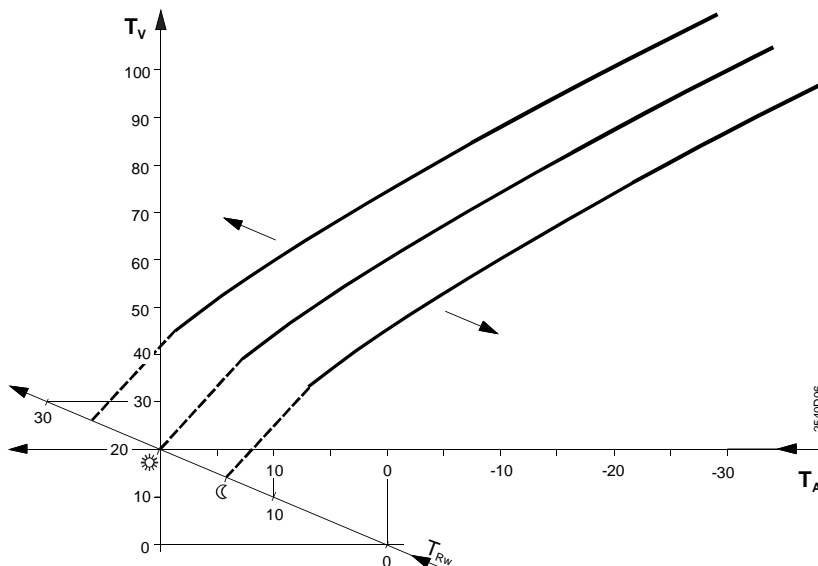

Parallel displacement of heating curve

s Slope

T_A Outside temperature

T_V Flow temperature

T_{Rw} Room temperature setpoint

12.6.5 Display of the setpoints

2 setpoints result from the basic setting, the position of the setting knob and – if made – the entry on operating line 72, which can be called up on operating line 166:

- TV1, resulting flow temperature setpoint at an outside temperature of +15 °C
- TV2, resulting flow temperature setpoint at an outside temperature of –5 °C

These 2 current setpoints determine the actual heating curve from which – as a function of the composite outside temperature – the current flow temperature setpoint is generated. It can be called up on operating line 165 (also refer to chapter “30 Function block “Service functions and general settings”).

12.7 Generation of setpoint

12.7.1 Weather-compensated control

Weather-compensated control is used with plant types 1–x, 2–x and 3–x . The setpoint is generated via the heating curve as a function of the outside temperature. The temperature used is the **composite** outside temperature.

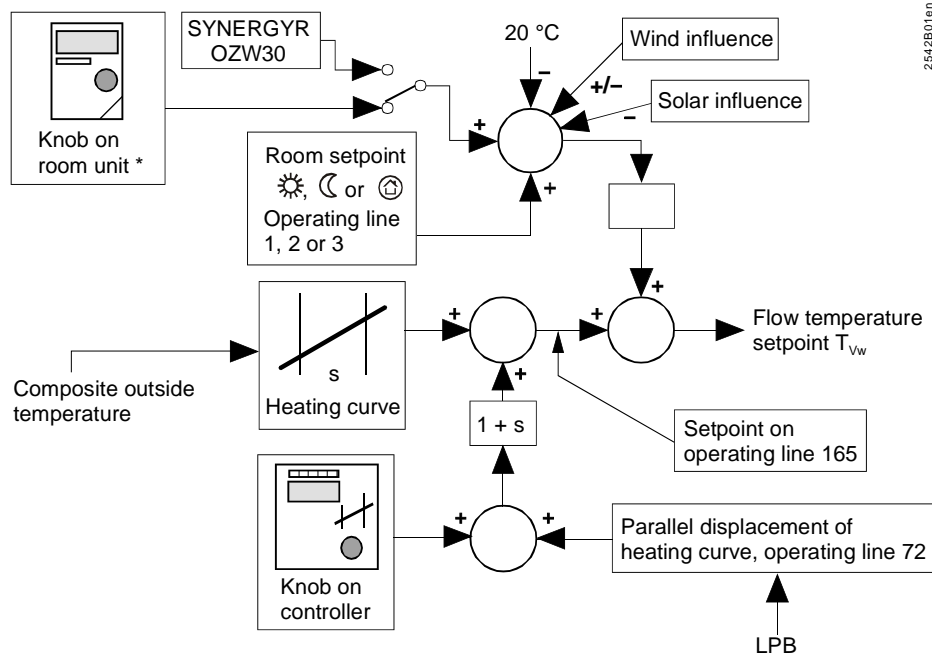

LPB Data bus
 OZW30 SYNERGYR central unit
 s Slope
 * Active only with room unit level ☀

The impact of the central unit OZW30 is described in section “35.2 Combination with SYNERGYR central unit OZW30 ”.

12.7.2 Demand-compensated control

Demand-compensated control is used with plant types 4–x and 5–x.

The setpoint is delivered to the RVL482 via the data bus (LPB) in the form of a heat demand signal. The outside temperature as well as the effect of wind and the impact of solar radiation are not taken into consideration.

13 Function block "3-position actuator heating circuit"

This function block provides weather-compensated 3-position control of the heating circuit. It acts in plant types 1-x, 2-x and 3-x.

13.1 Operating lines

Line	Function, parameter	Factory setting (range)	Unit
81	Maximum limitation of flow temperature	--- (--- / 0...140)	°C
82	Minimum limitation of flow temperature	--- (--- / 0...140)	°C
83	Maximum rate of flow temperature increase	--- (--- / 1...600)	°C/h
84	Boost of flow temperature setpoint mixing valve	10 (0...50)	°C
85	Actuator running time	120 (30...873)	s
86	P-band of control (Xp)	32.0 (1...100)	°C
87	Integral action time of control (Tn)	120 (30...873)	s

13.2 Limitations

13.2.1 Flow temperature limitations

The following settings can be made:

- Maximum limitation of the flow temperature. At the limit value, the heating curve runs horizontally. This means that the flow temperature setpoint cannot exceed the maximum value
- Minimum limitation of the flow temperature: At the limit value, the heating curve runs horizontally. This means that the flow temperature setpoint cannot fall below the minimum value (exception: with locking signals)

If the setpoint is limited, the display shows:

\bar{f} = for maximum limitation

\bar{j} = for minimum limitation

Both limitations can be deactivated (setting ---).

13.2.2 Setpoint rise

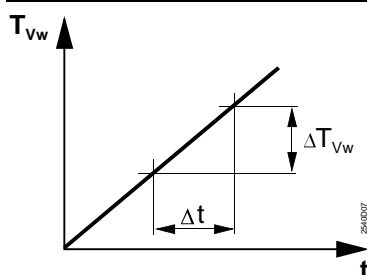

$$\text{Maximum rise: } = \frac{\Delta T_{vw}}{\Delta t}$$

- t Time
- Δt Unit of time
- T_{vw} Flow temperature setpoint
- ΔT_{vw} Rate of setpoint increase per unit of time

The rate of increase of the flow temperature setpoint can be limited to a maximum. In that case, the maximum rate of increase of the flow temperature setpoint is the selected temperature per unit of time (°C per hour).

This function:

- prevents cracking noises in the piping
- protects objects and construction materials that are sensitive to quick temperature increases (e.g. antiques)
- prevents excessive loads on heat generating equipment

This function can be deactivated (setting ---).

13.2.3 Impact of d.h.w. heating

Limitation of the rate of increase acts independently of d.h.w. heating.

13.3 3-position control

3-position control operates as weather- or demand-compensated PI flow temperature control. The flow temperature is controlled through a modulating actuating device (slipper or seat valve). Owing to the I-part, there is no control offset.

The controller's positioning commands to the actuating device are delivered to the output relays and indicated by LEDs.

13.4 Excess mixing valve temperature

An excess mixing valve temperature can be entered on the RVL482. This is a boost of the respective heating zone's flow temperature setpoint. The higher setpoint is delivered to the heat generating equipment as the heat demand signal.

The excess mixing valve temperature is set on the controller that drives the mixing valve (controller N2 in the example below) (operating line 84).

Example interconnected plant

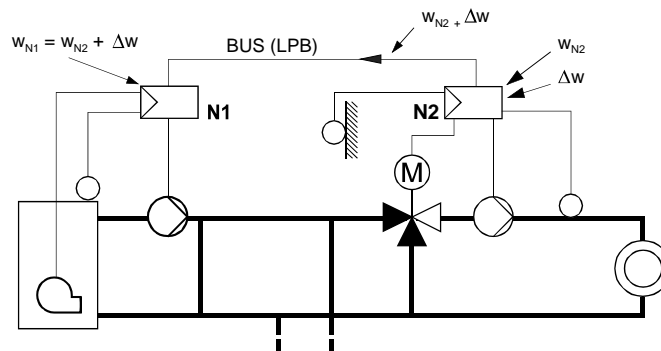

N1	Boiler temperature controller (heat generation)
N2	Flow temperature controller (heating zone)
w_{N1}	Setpoint of boiler temperature controller
w_{N2}	Setpoint of flow temperature controller
Δw	Excess mixing valve temperature (set on controller N2)

13.5 Pulse lock

If, during a period of time that equals 5 times the running time, the actuator has received only closing pulses, additional closing pulses delivered by the controller will be locked. This minimizes the strain on the actuator.

For safety reasons, the controller delivers a one-minute closing pulse at 10-minute intervals.

An opening pulse negates the pulse lock.

14 Function block "Boiler"

Function block "Boiler" acts as a 2- or 3-position controller and is used for direct burner control.

The function block operates as a demand-compensated boiler temperature controller of a common flow, which supplies heat to one or several consumers.

14.1 Operating lines





Line	Function, parameter	Factory setting (range)	Unit
91	Operating mode of the boiler	0 (0...2)	
92	Maximum limitation of the boiler temperature	95 (25...140)	°C
93	Minimum limitation of the boiler temperature	10 (5...140)	°C
94	Switching differential of the boiler	6 (1...20)	°C
95	Minimum limitation of the burner running time	4 (0...10)	min
96	Release limit for second burner stage	50 (0...500)	°C×min
97	Reset limit for second burner stage	10 (0...500)	°C×min
98	Waiting time for second burner stage	20 (0...40)	min

14.2 Operating mode

The boiler's operating mode for situations when there is no demand for heat (e.g. due to the ECO function) can be selected. 3 operating modes are available:

- With manual shutdown: The boiler will be shut down when there is no demand for heat and operating mode protection  is selected (setting 0 on operating line 91)
- With automatic shutdown: The boiler will be shut down when there is no demand for heat, irrespective of the selected operating mode (setting 1 on operating line 91)
- With no shutdown: The boiler will never be shut down; it always maintains the minimum setpoint (setting 2 on operating line 91)

Boiler operating modes, when there is no demand for heat.

Controller's operating mode	Boiler operating mode		
	With manual shut-down	With automatic shut-down	With no shut-down
 Protection	Boiler OFF	Boiler OFF	Boiler at minimum limit value
Auto  AUTO	Boiler at minimum limit value	Boiler OFF	Boiler at minimum limit value
 REDUCED	Boiler at minimum limit value	Boiler OFF	Boiler at minimum limit value
 NORMAL	Boiler at minimum limit value	Boiler OFF	Boiler at minimum limit value

With plant types 4-x and 5-x, it is not possible to select all operating modes (refer to section "3.7 Plant type and operating mode").

When there is demand for heat, the boiler always supplies heat, which means that the boiler's operating mode in that case is always ON.

14.3 Limitations

14.3.1 Maximum limitation of the boiler temperature

For maximum limitation of the boiler temperature, the maximum limit value can be adjusted. The switch-off point cannot exceed the maximum limit value. The switch-on point will then be lower by the amount of the set switching differential.

If the return temperature is limited to a maximum, the display shows \bar{f} .

This maximum limitation cannot be used as a safety function; for that purpose, thermostats, thermal reset limit thermostats, etc., must be used.

14.3.2 Minimum limitation of the boiler temperature

For minimum limitation of the boiler temperature, the minimum limit value can be adjusted. The switch-on point cannot fall below the minimum limit value. The switch-off point will then be higher by the amount of the set switching differential.

If the return temperature is limited to a minimum, the display shows \bar{j} .

14.3.3 Actions during d.h.w. heating

Both maximum and minimum limitation also act during d.h.w. heating.

14.4 Control with a multistage burner

When using a multistage burner, boiler temperature control is provided in the form of 2-position control.

2-position control maintains the required boiler temperature by switching a single- or 2-stage burner on and off.

The controller's commands to the burner or burner stages are delivered via the output relays and indicated by LEDs.

14.4.1 Control with a single-stage burner

For 2-position control with a single-stage burner, the variables that can be set are the switching differential and the minimum burner running time.

The controller compares the actual value of the boiler temperature with the setpoint. If the boiler temperature falls below the setpoint by half the switching differential, the burner will be switched on. If the boiler temperature exceeds the setpoint by half the switching differential, the burner will be switched off.

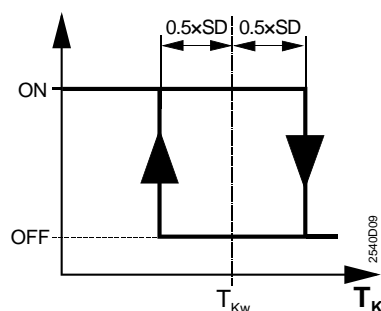

SD Switching differential
 T_K Boiler temperature
 T_{Kw} Boiler temperature setpoint

If there is no more deviation before the minimum burner running time has elapsed, the burner will nevertheless continue to operate until that time is completed (burner cycling protection).

This means that the minimum burner running time has priority. Maximum limitation of the boiler temperature will be maintained, however, which always leads to burner shut-down.

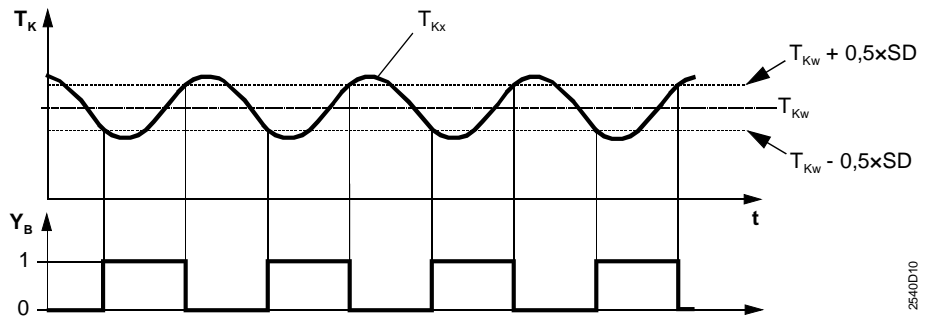

SD Switching differential
t Time
T_K Boiler temperature
T_{Kw} Boiler temperature setpoint
T_{Kx} Actual value of boiler temperature
Y_B Burner control signal

2540D10

Setting note

When controlling a single-stage burner, the reset integral of the second stage should be set to zero.

14.4.2 Control with a 2-stage burner

Setting parameters

For 2-position control with a 2-stage burner, the variables that can be set are the switching differential and the minimum burner running time – which now apply to both stages – plus the following variables:

- The release integral (FGI) for the second stage. This is the variable generated from the temperature (T) and time (t). If the maximum limit is exceeded, the second burner stage is released and can switch on, provided the minimum waiting time for the second stage has elapsed. Pre-requisite is that the minimum locking time for the second stage has elapsed.

$$FGI = \int_0^t \Delta T dt \quad \text{where: } \Delta T = (w - 0.5 \times SD - x) > 0$$

- The reset integral (RSI). This is the variable generated from the temperature (T) and time (t). If the maximum limit is exceeded, the burner will be locked and switches off

$$RSI = \int_0^t \Delta T dt \quad \text{where: } \Delta T = (x - w + 0.5 \times SD) > 0$$

- The minimum locking time for the second stage, which is the period of time on completion of which the second stage can switch on at the earliest

Control process

The controller compares the actual value of the boiler temperature with the setpoint. If it falls below the setpoint by half the switching differential ($x < w - 0.5 \times SD$), the first burner stage will be switched on. At the same time, the minimum waiting time for the second burner stage commences and the release integral is being generated. The controller ascertains for how long and by how much the boiler temperature remains below $w - 0.5 \times SD$. It continually generates the integral based on time and the progression of temperature.

If, on completion of the minimum locking time, the boiler temperature is below $w - 0.5 \times SD$, and if the release integral reaches the set maximum limit, the second burner stage will be released and switched on. The boiler temperature starts rising. When the boiler temperature has exceeded the setpoint by half the switching differential ($x = w + 0.5 \times SD$), the second burner stage is switched off again, but will remain released. The first stage continues to operate. If the boiler temperature drops, the second stage will be switched on again at $x < w - 0.5 \times SD$. The setpoint is now maintained by the second burner stage.

If, however, the boiler temperature continues to rise ($x > w + 0.5 \times SD$), the controller starts generating the reset integral. It determines for how long and to what extent the

boiler temperature stays above the setpoint by half the switching differential. It continually generates the reset integral based on time and the progression of temperature. When the reset integral reaches the set maximum limit, the second burner stage will be locked and the first stage switched off.

The minimum locking time and calculation of the release integral at $x < w - 0.5 \times SD$ are started when the switch-on command for the first burner stage is given.

Due to the time-temperature integral, it is not only the duration of the deviation that is considered, but also its extent, when deciding whether the second stage shall be switched on or off.

SD Switching differential
w Boiler temperature setpoint
x Actual value of boiler temperature

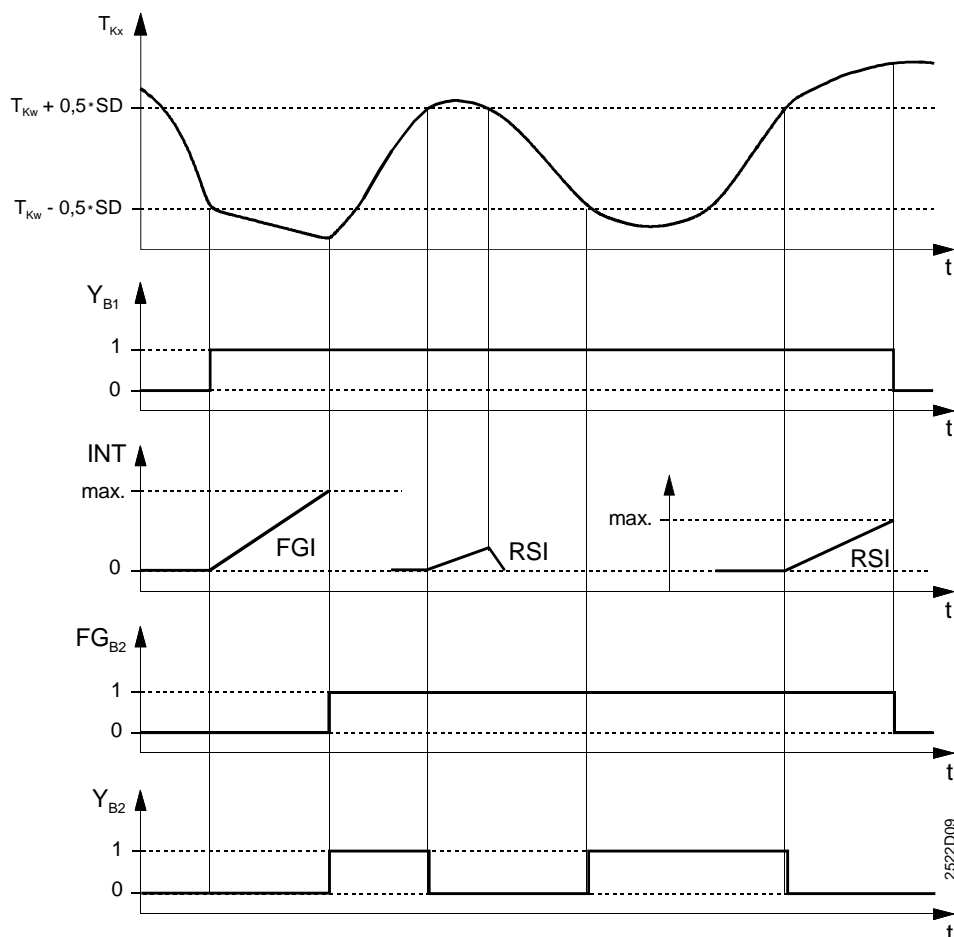

FG_{B2} Release of burner stage 2
FGI Release integral
INT Integral
RSI Reset integral
SD Switching differential
t Time
T_{Kw} Boiler temperature setpoint
T_{Kx} Actual value of boiler temperature
Y_{B1} Control signal for burner stage 1
Y_{B2} Control signal for burner stage 2

14.5 Control with a modulating burner

When using a modulating burner, the boiler temperature is controlled by switching the basic stage (2-position control) and by controlling the damper actuator of the modulating burner (3-position control).

14.5.1 Setting parameters

In addition to the adjustable variables used with the 2-stage burner, the setting parameters according to chapter "10 Function block "Modulating burner"" are required for the control of a modulating burner. Using these additional setting parameters, the control process can be matched to the behavior of the plant (controlled system).

14.5.2 Control

The functioning with regard to activation and deactivation of the basic stage corresponds to that of 2-stage burner operation. Release of modulation is analogous to the release of the second burner stage. Upon release of modulation, the burner's modulating operation is controlled in the form of 3-position control (PID mode).

The 3-position controller uses a neutral zone which has a band of ± 1 K about the current boiler temperature setpoint. If the boiler temperature remains within that neutral zone for more than 16 seconds, no more positioning pulses will be delivered for the burner's modulating operation.

If the boiler temperature does not stay long enough within the neutral zone, or if it lies outside, the damper actuator of the modulating burner will be opened or closed by positioning pulses.

14.6 Frost protection for the boiler

Frost protection for the boiler operates with fixed values:

- Switch-on point: 5 °C boiler temperature
- Switch-off point: Minimum limit of the boiler temperature plus switching differential

If the boiler temperature falls below 5 °C, the burner will always be switched on until the boiler temperature has crossed the minimum limit by the amount of the switching differential.

With plant types 3-x and 5-x, pump M4 is also switched on during that period of time.

14.7 Protective boiler startup

14.7.1 Plant types 2–x and 4–x:

If the boiler temperature falls below the minimum limit of the boiler temperature while the burner is running, the differential (minimum limit value minus actual value) will be integrated. From this, a critical locking signal will be generated and transmitted to the connected loads. This causes the loads to reduce their setpoints, thus consuming less energy. If the critical locking signal exceeds a defined value, pump M1 will be switched off in addition, depending on the setting made on operating line 99 (operating mode of pump M1). The locking signals have no impact on the bypass pump.

If the boiler temperature returns to a level above the minimum limit, the integral will be reduced, resulting in a reduction of the critical locking signal. If the integral falls below a defined level, pump M1 will be activated again if it had been deactivated. The connected loads will raise their setpoint values again.

When the integral reaches the value of zero, protective boiler startup will be deactivated, in which case the critical locking signal is zero.

Protective boiler startup can be interrupted to ensure that, in the event of a burner fault, for instance, frost protection for the plant will be provided.

In the case of protective boiler startup and simultaneous frost protection for the plant, the boiler temperature gradient must turn positive within 15 minutes. Otherwise, the locking signal will become invalid for at least 15 minutes.

On completion of the 15 minutes, protective boiler startup will become active again as soon as the boiler temperature gradient turns positive.

If the boiler effects protective boiler startup, the boiler temperature controller's display shows J .

Protective boiler startup cannot be deactivated.

Section "30.4.7 Gain of locking signal" provides information on who receives the boiler temperature controller's critical locking signal and how the loads respond to it.

Autonomous unit:



Interconnected plant:

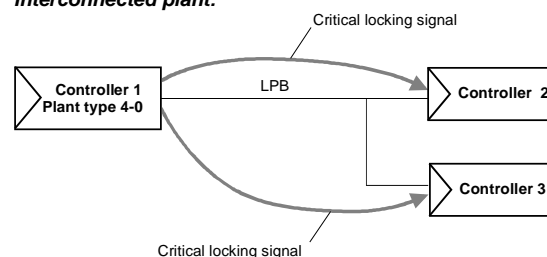

14.7.2 Plant types 3–x and 5–x

If – while the burner is running and there is a temperature demand from one of the loads – the boiler temperature falls below the minimum boiler limit value, no locking signal will be generated and the mixing valve in the boiler return will not be acted upon. Limitation will not be shown on the display.

If – while the burner is running and there is no temperature demand from one of the loads – the boiler temperature falls below the minimum boiler limit value, pump M4 will be activated and the mixing valve in the boiler return remains fully closed. The display shows the limitation as J . When the boiler temperature rises again, exceeding the boiler's minimum limit value by the switching differential (operating line 94), pump M4 and the burner will be switched off.

14.8 Protection against boiler overtemperatures

To prevent heat from building up in the boilers (protection against overtemperatures), the RVL482 offers a protective function.

When the first burner stage is switched off, the controller allows pump M1 to overrun for the set pump overrun time (operating line 174 on the boiler temperature controller), generating at the same time a forced signal to all loads (inside the controller on the data bus). If the boiler temperature controller is located in segment 0, the forced signal will be delivered to all loads in all segments. By contrast, if the boiler temperature controller is located in segment 1...14, the signal will only be sent to the loads in the same segment.

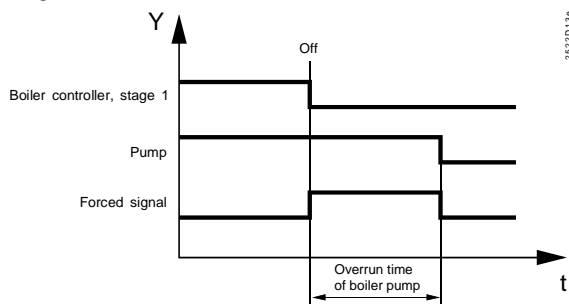

t Time
Y Control signal pump M1

All loads (heating and d.h.w. circuits) and heat exchangers that abruptly reduce their demand for heat watch the data bus during the set pump overrun time to see if a forced signal is being sent by the boiler.

- If no forced signal is received, the loads and the heat exchanger only make a pump overrun (refer to section "30.4.4 Pump overrun")
- If, in this time window, a forced signal is received, the loads continue to draw heat from the boiler in the following manner:
 - Plant types with heating circuits using a mixing valve maintain the previous set-point
 - Plant types with pump heating circuits allow the pumps to continue running

D.h.w. plant type 3 (instantaneous d.h.w. heating via heat exchanger) does not respond to forced signals since it can draw heat from the boiler only if there is demand for d.h.w. If the boiler sets the forced signal to zero, the loads and heat exchangers that have responded to the forced signal respond as follows:

- They close their mixing valves
- Their pumps run for the set pump overrun time and then stop

D.h.w. discharging protection has priority over protection against boiler overtemperatures.

15 Function block "Pump M1"

This function block provides control of pump M1. This pump can be used either as a circulating pump or bypass pump, each with selectable control criteria.

15.1 Operating lines

Line	Function, parameter	Factory setting (range)	Unit
99	Operating mode of pump M1	1 (0...3)	
100	Switching differential of bypass pump	6 (1...20)	°C

15.2 Description

Depending on the plant type, pump M1 is used either as a circulating or bypass pump.

15.2.1 Plant types 2-x and 4-x

With these plant types, pump M1 can be used either as a circulating pump or bypass pump. For that, the required operating mode is to be selected on operating line 99:

- Circulating pump with no deactivation (setting 0):
The circulating pump runs when one of the consumers calls for heat and when burner stage 1 is switched on, that is, also during protective boiler startup.
- Circulating pump with deactivation (setting 1):
The circulating pump runs when one of the consumers calls for heat. It is deactivated during protective boiler startup
- Bypass pump parallel to burner stage 1 (setting 2):
The bypass pump always runs when burner stage 1 operates
- Bypass pump with control via the return temperature (setting 3):
The bypass pump is controlled via return sensor B7:
 - The pump is switched on when the return temperature (B7) falls below the minimum return temperature (operating line 101) and one of the consumers demands heat from the boiler
 - The pump is switched off when the return temperature (B7) exceeds the minimum return temperature by the amount of the switching differential, or when none of the consumers demands heat from the boiler. The switching differential can be set on operating line 100

If, on function block "Setpoint of return temperature limitation", this function is deactivated (no minimum return temperature entered on operating line 101), the bypass pump will constantly be off.

Caution

If, with plant type 4-x, the selected device number is >1, settings 2 and 3 lead to an error message (error code 140).

15.2.2 Plant types 3-x and 5-x

With these plant types, this function block is deactivated. When there is a temperature demand from one of the consumers, pump M1 always runs, that is, also during protective boiler startup. When there is no temperature demand, the pump is off.

16 Function block "Setpoint of return temperature limitation"

On this function block, the setpoint of minimum and maximum limitation of the return temperature or the bivalent starting point can be set.

16.1 Operating line

<i>Line</i>	<i>Function, parameter</i>	<i>Factory setting (range)</i>	<i>Unit</i>
101	Setpoint of return temperature limitation / bivalent starting point	--- (--- / 0...140)	°C

16.2 Description

Operating line 101 is used to adjust the setpoints of the return temperature limitations (minimum or maximum) or the bivalent starting point.

When entering ---, the function is deactivated, which means that the return temperature will not be limited.

For more detailed information about these functions, refer to chapter "17 Function block "Type of limitation of return temperature""

17 Function block "Type of limitation of return temperature"

This function block is used to select the type of limitation with the plant types that permit a choice of minimum or maximum limitation of the boiler return temperature.

17.1 Operating line

Line	Function, parameter	Factory setting (range)	Unit
102	Type of limitation of return temperature	0 (0 / 1)	

17.2 Settings

The type of limitation with plant types 1-x, 2-x and 4-x can be selected:

0 = Minimal limitation

1 = Maximum limitation

With plant types with own mixing valve in the boiler return (3-x and 5-x), it is always the minimum limitation of the boiler return temperature that is active. Operating line 102 will then be hidden.

If the plant uses a bypass pump controlled via return sensor B7, that setting will be inactive. In that case, the type of limitation will be fixed at minimum limitation. When the setting on the operating line is changed, the display will show *OFF*.

17.3 Acquisition of measured values

A temperature sensor with a sensing element LG-Ni 1000 is required in the return. With plant type 1-x with return temperature minimum limitation, the return temperature can also be delivered via LPB. In this case, only one return temperature sensor per segment may be used in interconnected plants.

17.4 Minimum limitation of the return temperature

With the RVL482, minimum limitation of the return temperature can be accomplished in 3 different ways:

- Reduction of the consumer setpoints (only with plant types 1-x, 2-x and 4-x)
- Reduction of the consumer setpoints and inclusion of the bypass pump (only with plant types 2-x and 4-x)
- Own mixing valve in the boiler return (only with plant types 3-x and 5-x)

Minimum limitation of the boiler return temperature prevents boiler corrosion resulting from flue gas condensation.

17.4.1 Minimum limitation through reduction of the consumer setpoints

This minimum limitation acts with plant types 1-x, 2-x and 4-x.

If the return temperature falls below the set minimum limit value, the temperature differential between minimum limit value and actual value will be integrated.

From this, a critical locking signal will be generated and transmitted to the connected loads. This causes the loads to reduce their setpoints, thus consuming less energy.

If the return temperature climbs back to a level above the minimum limit, the integral will be reduced, resulting in a reduction of the critical locking signal. The connected loads rise their setpoint values.

When the integral reaches the value of zero, the minimum return temperature limitation will be deactivated, in which case the critical locking signal is zero.

If minimum limitation of the return temperature is active, the display shows J .
 Minimum limitation of the return temperature can be deactivated.
 Section "30.4.7 Gain of locking signal" provides information on which the critical locking signal is sent to and how the loads respond to it.
 The minimum limit value is to be set on operating line 101.
 Setting --- = (inactive)

17.4.2 Mode of operation with a single device (with no bus)

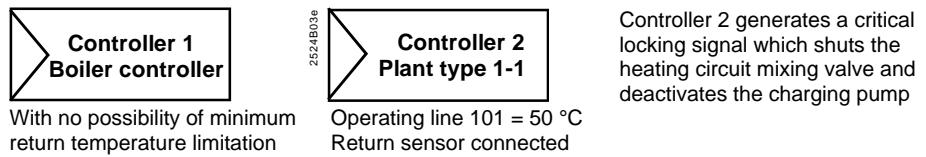

17.4.3 Mode of operation in interconnected plants

Central action of limitation

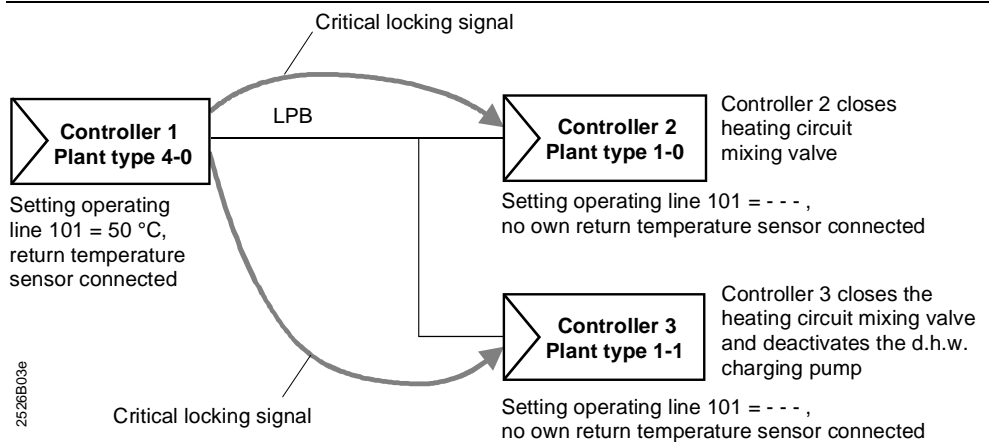

Local action of limitation

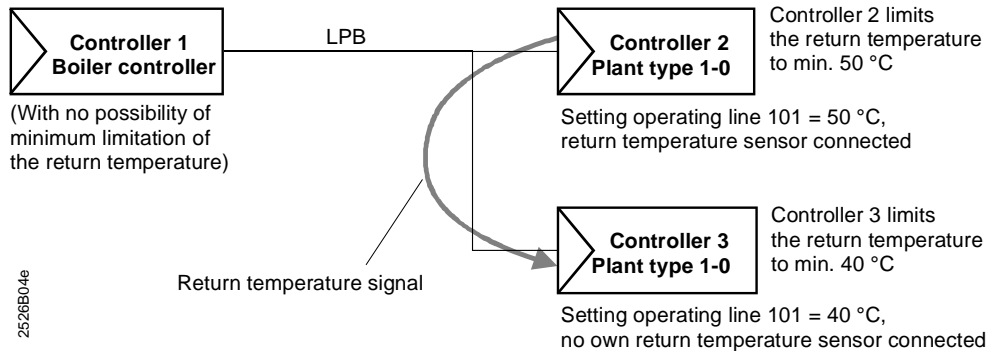

The zone controller with its own return temperature sensor (plant type 1-x) passes the return temperature to the other zone controllers in the same segment, which can provide minimum limitation of the return temperature on a local basis, depending on the settings made. This means they generate a critical locking signal internally. For response to critical locking signals, refer to section "30.4.7 Gain of locking signal"

17.4.4 Minimum limitation through reduction of the consumer setpoints, with inclusion of the bypass pump

This kind of minimum limitation only acts with plant types 2–x and 4–x. It comprises 2 functions:

- On the one hand, minimum limitation is accomplished through a reduction of the consumer setpoints. For a description of this function, refer to the preceding section "Limitation through reduction of the consumer setpoints"
- In addition to the delivery of critical locking signals to the consumers, the bypass pump will be activated and deactivated. Control takes place via return temperature B7 (operating line 99 = 3).
The function of the bypass pump is described in chapter "15 Function block "Pump M1""

17.4.5 Minimum limitation with mixing valve in the boiler return

This kind of minimum limitation is only possible with plant types 3–x and 5–x. The boiler return has its own mixing valve and boiler pump M4 for minimum limitation of the return temperature. The return temperature is acquired with sensor B7 and controlled to the setpoint adjusted on operating line 101 with an own control loop and mixing valve Y7. Locking signals resulting from minimum limitation of the return temperature will not be generated.

The control and boiler pump M4 operates only when there is demand for heat from one of the consumers or when burner stage 1 operates. If the burner stage operates with no demand for heat from one of the consumers, pump M4 runs, but the mixing valve in the boiler return remains shut.

If minimum limitation of the return temperature is active, the display shows \downarrow . Display \downarrow appears when the mixing valve receives a CLOSE command and disappears only when, during its running time, the mixing valve has only received OPEN commands from the controller.

The actuator's running time, the P-band and the integral action time can be set on function block "3-position actuator d.h.w. / return mixing" (chapter 13).

Minimum limitation of the return temperature can be deactivated on operating line 101.

17.5 Maximum limitation of the return temperature

With the RVL482, maximum limitation of the return temperature can be accomplished in 2 different ways:

- Maximum limitation of the return temperature acting on the mixing valve of the heating circuit (only with plant type 1–x)
- Maximum limitation of the return temperature acting on the boiler (only with plant types 2–x and 4–x)

17.5.1 Maximum limitation acting on the mixing valve in the heating circuit

This kind of maximum limitation is possible with plant types 1–x.

For certain types of heat sources (e.g. heat pumps), it may be practical to use maximum limitation of the heating circuit's return temperature. If the return temperature (sensor B7) exceeds the maximum value set on operating line 101, the heating circuit's flow temperature setpoint will be reduced. When the return temperature drops below the limit value, the reduction of the flow temperature setpoint will be negated again. This function is provided by an I-controller whose integral action time can be set on operating line 114.

If maximum limitation of the return temperature is active, the display shows \uparrow .

For this type of application, sensor B7 must be located in the heating circuit's return (upstream of the mixing point in the return), as shown below.

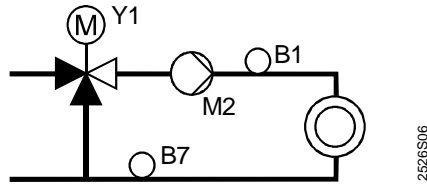

- B1 Heating circuit flow temperature sensor
- B7 Return temperature sensor
- M2 Heating circuit pump
- Y1 Heating circuit mixing valve

17.5.2 Maximum limitation acting on the boiler

This kind of maximum limitation is possible with plant types 2-x and 4-x. In the case of bivalent plant (e.g. oil-fired boiler and heat pump), it may be practical to use maximum limitation of the return temperature. If the return temperature (sensor B7) exceeds the limit value "Bivalent starting point" set on operating line 101, the boiler's setpoint will be reduced. Maximum setback of the boiler's setpoint is reached when the return temperature has attained the limit value "End point bivalent" set on operating line 104. The maximum reduction of the boiler's setpoint can be adjusted on operating line 103. But the boiler's setpoint cannot fall below the boiler's minimum temperature limitation (operating line 93).

When providing this function, boiler temperature control operates as a P-controller.

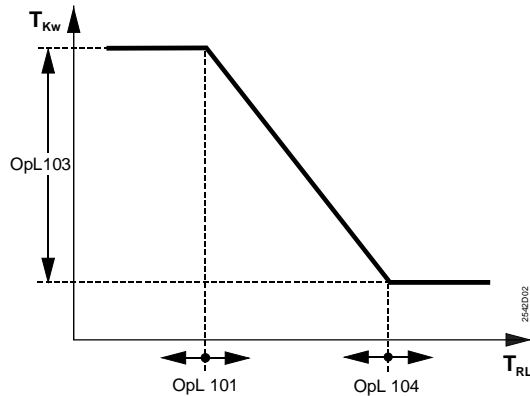

- OpL101 Operating line 101 (starting point bivalent)
- OpL 106 Operating line 103 (maximum setback of boiler temperature setpoint)
- OpL 104 Operating line 104 (end point bivalent)
- T_{Kw} Boiler temperature setpoint
- T_{RL} Return temperature

If maximum limitation of the return temperature is active, the display will show f .

For this type of application, sensor B7 must be located as shown below:

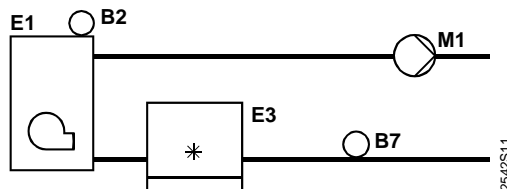

- B2 Boiler temperature sensor
- B7 Return temperature sensor
- E1 Boiler
- E3 Heat pump
- M1 Circulating pump

18 Function block "Bivalent maximum limitation of the return temperature"

This function block is used for setting the parameters required for the bivalent plant types 2-x and 4-x.

18.1 Operating lines

<i>Line</i>	<i>Function, parameter</i>	<i>Factory setting (range)</i>	<i>Unit</i>
103	Maximum setback of boiler setpoint	10 (1...50)	°C
104	End point bivalent	60 (0...140)	°C

18.2 Description

On operating line 103, maximum setback of the boiler setpoint can be set, and on operating line 104, "End point bivalent" for setting back the boiler's setpoint.

"Start point bivalent" for setting back the boiler's setpoint is to be entered on operating line 101 of function block "Setpoint of return temperature limitation".

For more detailed information about these functions, refer to section "17.5.2 Maximum limitation acting on the boiler"

19 Function block "3-position actuator mixing circuit"

This function block is used with plant types 3-x and 5-x to set the control parameters of the mixing circuit.

19.1 Operating lines

<i>Line</i>	<i>Function, parameter</i>	<i>Factory setting (range)</i>	<i>Unit</i>
108	Actuator running time	120 (30...873)	s
109	P-band of control (Xp)	32.0 (1...100)	°C
110	Integral action time of control (Tn)	120 (10...873)	s

19.2 Control

The 3-position controller provides PI control. The return temperature is controlled to the minimum return temperature setpoint through modulating control of the mixing valve. The actuator running time, P-band (Xp) and integral action time (Tn) can be adjusted.

20 Function block "Integral action time maximum limitation of the return temperature"

On this function block, the integral action time of maximum limitation of the return temperature can be set with plant types 1–x.

20.1 Operating lines

<i>Line</i>	<i>Function, parameter</i>	<i>Factory setting (range)</i>	<i>Unit</i>
114	Integral action time of maximum limitation of the return temperature	30 (0...60)	min

20.2 Description

On operating line 114, the integral action time of maximum limitation of the return temperature acting on the heating circuit's mixing valve can be set.

For more detailed information about these functions, refer to section "17.5.1 Maximum limitation acting on the mixing valve in the heating circuit".

21 Function block "Assignment of d.h.w. heating"

This function block is used to select the heating circuits for which the d.h.w. is heated and according to which program the d.h.w. circulating pump shall run.

21.1 Operating lines

<i>Line</i>	<i>Function, parameter</i>	<i>Factory setting (range)</i>	<i>Unit</i>
121	Assignment of d.h.w. heating	0 (0...2)	

21.2 Assignment of d.h.w. heating

Operating line 121 is used to select for which heating circuits the d.h.w. is heated, that is, which heating circuits draw their water from the same source.

<i>Operating line 121</i>	<i>Explanation</i>
0	D.h.w. heating is only provided for the heating circuit associated with the own controller. With plant types 4-x and 5-x, this setting makes no sense since no own heating circuit exists (no d.h.w. in that case).
1	D.h.w. heating is only provided for the heating circuits of the controllers with the same segment number that are connected to the data bus (LPB)
2	D.h.w. heating is provided for all heating circuits of the controllers connected to the data bus (LPB)

The setting is required in connection with operating lines 122 (circulating pump program) and 123 (release of d.h.w. heating).

22 Function block "Circulating pump"

Based on the settings made, function block "Circulating pump" determines at what times the circulating pump will run.

22.1 Operating line

Line	Function, parameter	Factory setting (range)	Unit
122	Program for the circulating pump	2 (0...3)	

22.1.1 General mode of operation

On operating line 122, it can be entered according to which time schedule the d.h.w. circulating program shall run. The use of a circulating pump is optional with all types of plant.

Important

With d.h.w. plant type x-3, "d.h.w. heating with heat exchanger", it is strongly recommended to use a circulating pump, the reason being control performance.

That circulating pump runs only when d.h.w. heating is switched on (button  lit). The circulating pump runs at the following times, depending on the setting made on operating line 122:





Operating line 122	The circulating pump runs
0	continuously (24 hours a day)
1	according to one or several heating programs
2	according to switching program 2 of own controller
3	according to switching program 3 of own controller

With setting 1, operation of the circulating pump depends on the setting made on operating line 121. In an interconnected plant with several controllers, that is, with several heating programs, the circulating pump runs when at least one of the controllers provides heating to the NORMAL temperature according to its heating program (independent of the operating mode) and is not in holiday mode.





The circulating pump runs with a forward shift against the times of the heating program; this means it is affected by optimum start control.

With plant types 4-x and 5-x and the setting of 0 (own controller) on operating line 121, the circulating pump never runs since these plant types have no own heating program. 2 examples are given below to show the behavior of the circulating pump when controllers A, B, C and D are interconnected via data bus:

Example 1

Operating line		Controllers	Operating mode	Heating program, holidays	Circulating pump
121	122				
2	1	A	Auto 	06:00...18:00	Circulating pump runs from 06:00 to 23:00
		B		07:00...23:00	
		C	Auto 	07:00...22:00	
		D	Auto 	03:00...22:00, holidays	

Example 2

Operating line		Controllers	Operating mode	Heating program, holidays	Circulating pump
121	122				
2	1	A	Auto 	06:00:00..0.18:00, optimum start control shifts forward by 2 hours	Circulating pump runs from 04:00 to 23:00
		B		08:00...23:00	
		C	Auto 	07:00...22:00	
		D		05:00...21:00	

22.2 Operation of circulating pump during the holiday period

During the holiday period, the circulating pump runs according to the setting made, as shown in the following table:

<i>Operation line 121</i>	<i>Operation line 122</i>	<i>Operation of circulating pump</i>
0	0, 1, 2, or 3	Circulating pump OFF, if own controller in holiday mode
1	0, 1, 2, or 3	Circulating pump OFF, if all controllers having the same segment number are in holiday mode
2	0, 1, 2, or 3	Circulating pump OFF, if all controllers in the interconnected system are in holiday mode

22.3 Frost protection for d.h.w.

Frost protection for d.h.w. provided by the RVL482 is assured by the sensors B3, B31 and B32. The behavior depends on the type of plant.

22.3.1 Frost protection in the d.h.w. storage tank

This type of frost protection is used with plant types x-1 and x-2. It always ensures a minimum switch-on temperature of 5 °C. If the temperature measured with sensor B31 or B32 falls below 5 °C, storage tank charging will immediately be started (independent of other settings), which generates a heat requisition to the precontroller. The switch-off temperature is at 5 °C plus the switching differential (set on operating line 128).

Important

When using thermostats, there is no frost protection for the d.h.w. storage tank.

22.3.2 Frost protection in the d.h.w. storage tank flow

This type of frost protection is used with plant types x-2.

If the d.h.w. flow temperature (acquired with sensor B3) falls below 5 °C, the charging pump starts to run. The mixing valve will not be opened and there will be no heat requisition to the precontroller.

The switch-off temperature is 6 °C.

22.3.3 Frost protection in the secondary d.h.w. flow

With plant types x-3, no frost protection for d.h.w. can be provided since it cannot be made certain that sensor B3 will acquire the temperature in the heat exchanger when d.h.w. heating is switched off (circulating pump OFF).

23 Function block "Release, priority and flow temperature setpoint of d.h.w."

Based on the settings made, function block "Release, priority and flow temperature setpoint of d.h.w." determines

- at what times d.h.w. is released to be heated to the NORMAL d.h.w. temperature setpoint
- the type of priority of d.h.w. heating (absolute, shifting, or parallel)
- generation of the setpoint of the common flow temperature (d.h.w., maximum selection)

23.1 Operating lines

Line	Function, parameter	Factory setting (range)	Unit
123	Release of d.h.w. heating	2 (0...2)	
124	D.h.w. priority, flow temperature setpoint	0 (0...4)	

23.2 Release

23.2.1 Function

On operating line 123, it can be selected at what times d.h.w. shall be released to be heated to the NORMAL d.h.w. temperature setpoint.

Released means:

- With plants equipped with a d.h.w. storage tank (plant types x-1 and x-2): Storage tank will be recharged as needed
- With plants using instantaneous d.h.w. heating (plant type x-3): The valve in the primary return is controlled such that the required d.h.w. temperature will be reached at sensor B3

This function allows d.h.w. heating to maintain the REDUCED d.h.w. setpoint during nonoccupancy times (at night), or to prevent d.h.w. heating (e.g. during holiday periods).

If d.h.w. heating in the summer takes place alternately with an electric immersion heater, the latter will be released continuously – independent of the setting made on operating line 123 – that is, 24 hours a day.

Mechanism of d.h.w. heating release:

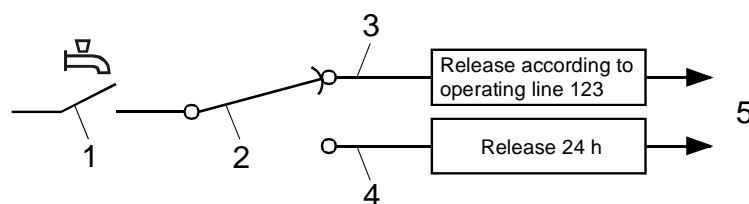

- 1 D.h.w. button
- 2 Type of charging (heating / electric immersion heater)
- 3 D.h.w. heating with hot water
- 4 D.h.w. heating with electric immersion heater
- 5 D.h.w. heating

With all plant types x-4, d.h.w. heating is always released as long as it is switched on.

23.2.2 Release programs

Depending on the setting made on operating line 123, release of d.h.w. heating takes place at the following times:

Setting	D.h.w. heating is released
0	Continuously (24 hours a day)
1	According to one or several heating programs
2	According to switching program 2 of own controller





With setting 1, d.h.w. release depends on the setting made on operating line 121. In an interconnected system of several controllers, that is, in the case of several heating programs, the circulating pump runs if at least one of the connected controllers provides heating to the NORMAL temperature according to its heating program (independent of the operating mode), and is not in holiday mode.

Release of d.h.w. heating is shifted forward in time by one hour against the times of the heating program. If optimum start control is active, the optimized switch-on times are used – and not the times entered.





With plant types 4–x and 5–x, and the setting of 0 (own controller) on operating line 121, d.h.w. heating will never be released since these plant types have no own heating program.

The release of d.h.w. heating is explained using 2 examples, in which controllers A, B, C and D are interconnected via the data bus:

Example 1

Operating line		Controllers	Operating mode	Heating program, optimization, holidays	Release
121	123				
2	1	A	Auto 	06:00...18:00, no optimization	D.h.w. heating is released from 04:00 to 23:00
		B		07:00...23:00	
		C	Auto 	07:00...22:00, optimum start control shifts forward by 2 hours	
		D	Auto 	03:00...22:00, holidays	

Example 2

Operating line		Controllers	Operating mode	Heating program, optimization, holidays	Release
121	123				
2	1	A	Auto 	06:00...18:00, no optimization	D.h.w. heating is released from 04:00 to 23:00
		B		08:00...23:00	
		C	Auto 	07:00...22:00, optimum start control shifts forward by 2 hours	
		D		05:00...21:00	

23.2.3 D.h.w heating during the holiday period

In holiday mode, d.h.w. heating is provided as follows:

Operating line 121	Operating line 123	D.h.w. heating
0	0, 1, or 2	No d.h.w. heating when own controller is in holiday mode
1	0, 1, or 2	No d.h.w. heating when all controllers in the same segment are in holiday mode
2	0, 1, or 2	No d.h.w. heating when all controllers in the interconnected system are in holiday mode

23.3 Priority and flow temperature setpoint

23.3.1 Settings

<i>Operating line 124</i>	<i>D.h.w. priority</i>	<i>Flow temperature setpoint according to</i>
0	Absolute	D.h.w.
1	Shifting	D.h.w.
2	Shifting	Maximum selection
3	None (parallel)	D.h.w.
4	None (parallel)	Maximum selection

23.3.2 D.h.w. priority

Depending on the capacity of the heat generating equipment, it may be practical to reduce the amount of heat drawn by the heating circuit(s) during d.h.w. heating, thus ensuring that the required d.h.w. temperature will be reached more quickly. This means that d.h.w. heating is given priority over space heating.

For this purpose, the controller offers 3 types of d.h.w. priority on operating line 124:

- Shifting priority
- Absolute priority
- No priority (parallel operation)

The priority is provided by delivering locking signals. The impact of the locking signals is described in section "30.4.7 Gain of locking signal".

23.3.3 Absolute priority

During d.h.w. heating, the heating circuits are locked, that is, they receive no heat.

- Controller with no bus connection:
During d.h.w. heating, the controller sends an uncritical locking signal of 100 % to its own heating circuit
- Controller with bus connection:
During d.h.w. charging, the controller informs the "Consumer master" that it presently performs d.h.w. charging with absolute priority. The consumer master is the unit with the same segment number as the controller with device number 1. The consumer master then sends an uncritical locking signal of 100 % to all controllers in the same segment. If the consumer master is in segment 0, the uncritical locking signal will be delivered to all controllers in all segments.

23.3.4 Shifting priority

During d.h.w. charging, the heating circuits will be throttled if the heat generating equipment (the boiler) is not able to maintain the required setpoint. In that case, the display of the boiler controller shows \downarrow .

- Controller with no bus connection:
If, during d.h.w. charging with shifting priority, the boiler is not able to maintain the setpoint, the differential between setpoint and actual value will be integrated and an integral-dependent uncritical locking signal in the range 0...100 % delivered to the own heating circuit.
Since shifting priority is determined by the boiler, this kind of priority is only possible with plant type 2-x. With plant types 1-x, setting "Shifting priority" has the same impact as setting "No priority".
- Controller with bus connection:
During d.h.w. heating, the controller signals the heat source in the same segment (controller and heat source could be identical) that it presently provides d.h.w. heating with shifting priority. If, now, the boiler is not able to maintain its setpoint, the differential between setpoint and actual value will be integrated and an integral-

dependent uncritical locking signal in the range 0...100 % generated. If the heat source is located in segment 0, it delivers the locking signal to all controllers in all segments. If the heat source is in segment 1...14, it only sends the locking signal to the controllers in the same segment.

23.3.5 No priority

No priority means parallel operation. D.h.w. charging has no impact on the heating circuits.

23.3.6 Flow temperature setpoint

With the types of priority "Shifting priority" and "No priority", the temperature setpoint of the common flow, which is used for both d.h.w. charging and space heating, can be generated in 2 different ways:

- Flow temperature setpoint according to the maximum selection
- Flow temperature setpoint according to the d.h.w. demand

Function assignment is made on operating line 124.

With plant types 1-x, the temperature setpoint of the common flow is transmitted to the precontroller via the data bus.

With plant types 2-x and 3-x, the temperature setpoint of the common flow is valid for sensor B2.

With the plant types that have no own heating circuit (4-x and 5-x), the heating circuit demand is transmitted to the controller via data bus.

23.3.7 Maximum selection

In the case of d.h.w. heating, the temperature setpoint of the common flow for the d.h.w. and the heating circuit is generated from the 2 demands by maximum selection.

Example

It is assumed that the mixing heating circuit calls for 40 °C, the d.h.w. circuit for 65 °C. With d.h.w. charging, the setpoint of the common flow temperature will then be the higher of the 2, namely 65 °C.

23.3.8 D.h.w.

With d.h.w. heating, the temperature setpoint of the common flow for the d.h.w. and the heating circuit is that required for the d.h.w. circuit.

Example

It is assumed that the mixing heating circuit calls for 80 °C, the d.h.w. circuit for 65 °C. With d.h.w. charging, the setpoint of the common flow temperature will then be that of the d.h.w. circuit, namely 65 °C.

24 Function block "D.h.w. storage tank"

Based on the settings made, this function block performs all d.h.w. functions required for the plant types with d.h.w. storage tank.

Although plant types x-4 have a d.h.w. storage tank, this function block is not active (except operating line 126), since the electric immersion heater provides the functions independent of the RVL482.

The settings for solar d.h.w. heating are listed in the corresponding function block (operating lines 201...208, refer to chapter "33 Function block "D.h.w. solar charging"").

24.1 Operating lines

Line	Function, parameter	Factory setting (range)	Unit
125	D.h.w. charging	0 (0...3)	
126	D.h.w. temperature sensor / control thermostat	0 (0...5)	
127	D.h.w. charging temperature boost	10 (0...50)	°C
128	Switching differential of the d.h.w. temperature	8 (1...20)	°C
129	Maximum d.h.w. charging time	60 (--- / 5...250)	min
130	Setpoint of the legionella function	--- (--- / 20...100)	°C
131	Forced charging	0 (0 / 1)	

24.2 D.h.w. charging

The type of d.h.w. charging is to be entered on operating line 125. There are 2 basic choices:

- D.h.w. charging with hot water
- D.h.w. charging alternately with hot water and the electric immersion heater

If the selected type of heat source is "Modulating burner" (operating line 54), operating line 125 will be locked. In that case, charging will always take place with hot water.

24.2.1 D.h.w. charging with hot water

The setting on operating line 125 is 0.

The d.h.w. storage tank is charged exclusively with hot water throughout the year.

24.2.2 Charging with hot water and electricity

The setting on operating line 125 is 1, 2, or 3.

In the winter, the d.h.w. storage tank is charged with hot water from the heating system and, in the summer, with the electric immersion heater.

Changeover takes place based on the following criteria:

- Changeover from hot water charging to the electric immersion heater takes place when there is no demand for space heating for at least 48 hours (changeover at midnight)
- Changeover from the electric immersion heater to hot water charging is effected when there is demand for space heating. Depending on the setting made on operating line 125 (1, 2, or 3), different types of heat demand are considered for the changeover criterion:

Operating line 125	Criterion for changeover
1	Demand for space heating from own heating circuit
2	Demand for space heating from all controllers connected to the data bus (LPB), having the same segment number , including those from the own heating circuit
3	Demand for space heating from all controllers connected to the data bus (LPB), including those from the own heating circuit

With plant types 4-x and 5-x, setting 1 on operating line 125 makes no sense, since there is no own heating circuit. In that case, changeover to the electric immersion heater would take place at midnight at the latest, after 48 hours of operation.

24.3 D.h.w. temperature and d.h.w. switching differential

The kind of d.h.w. storage tank temperature acquisition must be selected on operating line 126.

In plant types x-4 **without** solar heating, select setting 0, 1, 2 or 3 on operating line 126, although d.h.w. heating with electric immersion heater does not require either sensor or thermostat.

The storage temperature can be acquired via

- 1 or 2 sensors
- 1 or 2 thermostats
- 1 or 2 sensors **with** solar function; this activates function "Solar d.h.w. charging".

If temperature sensors are used, the switch-on / off temperature for charging is determined as follows:

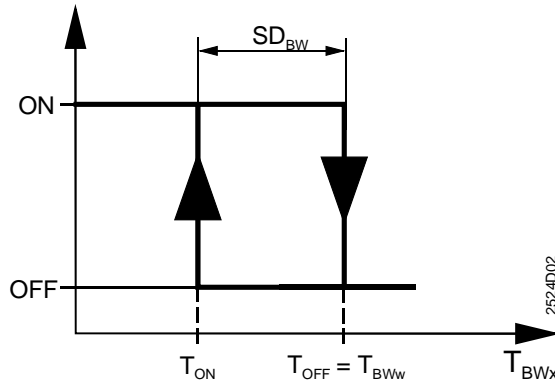

ON D.h.w. charging ON
 OFF D.h.w. charging OFF
 SD_{BW} Switching differential of d.h.w. charging
 T_{ON} Switch-on temperature
 T_{OFF} Switch-off temperature
 T_{BWw} D.h.w. temperature setpoint
 T_{BWx} D.h.w. temperature

If the d.h.w. storage tank uses thermostats for acquiring the temperature, the switch-on / off temperature is determined by them.

Determination of the switch-on temperature (start of d.h.w. charging):

Operating line 126	Measurement	Switching criterion
0	1 sensor	$T_{BWx1} < (T_{BWw} - SD_{BW})$
1	2 sensors	$T_{BWx1} < (T_{BWw} - SD_{BW})$ and $T_{BWx2} < (T_{BWw} - SD_{BW})$
2	1 thermostat	Thermostat contact B31 closed
3	2 thermostats	Both thermostat contacts B31 and B32 closed
4	1 sensor, solar d.h.w. heating	$T_{BWx1} < (T_{BWw} - SD_{BW})$
5	2 sensors, solar d.h.w. heating	$T_{BWx1} < (T_{BWw} - SD_{BW})$ and $T_{BWx2} < (T_{BWw} - SD_{BW})$

Determination of the switch-off temperature (end of d.h.w. charging):

Operating line 126	Measurement	Switching criterion
0	1 sensor	$T_{BWx1} > T_{BWw}$
1	2 sensors	$T_{BWx1} > T_{BWw}$ und $T_{BWx2} > T_{BWw}$
2	1 thermostat	Thermostat contact B31 open
3	2 thermostats	Both thermostats contact B31 and B32 open
4	1 sensor, solar d.h.w. heating	$T_{BWx1} > T_{BWw}$
5	2 sensors, solar d.h.w. heating	$T_{BWx1} > T_{BWw}$ and $T_{BWx2} > T_{BWw}$

SD_{BW} D.h.w. switching differential (operating line 128)
 T_{BWw} D.h.w. temperature setpoint (operating line 26 or 28)
 T_{BWx1} Measured value d.h.w. storage tank sensor 1 (B31)
 T_{BWx2} Measured value d.h.w. storage tank sensor 2 (B32)

From the 2 tables above, it is obvious that when using 2 sensors, it is irrelevant which of the 2 sensors is fitted at the top and which at the bottom of the d.h.w. storage tank.

24.4 Boost of the d.h.w. charging temperature

The boost of the d.h.w. charging temperature in °C can be set on operating line 127. The boost refers to the setpoint of the d.h.w. temperature. The lower the setting of this value, the longer d.h.w. charging takes.

$$T_{Lw} = T_{BWw} + T_{BW\Delta} \quad [^{\circ}\text{C}]$$

Example

Setpoint of the d.h.w. temperature (T_{BWw} , operating line 26)	= 50 °C
Boost of the d.h.w. charging temperature ($T_{BW\Delta}$, operating line 127)	= 10 °C
Resulting setpoint of the charging temperature TLw	= 60 °C

If thermostats are used, the boost of the d.h.w. charging temperature must still be set.

24.5 Maximum d.h.w. charging time

The maximum charging time for d.h.w. storage tanks can be set on operating line 129. This function is always active, independent of the type of d.h.w. priority (absolute, shifting, or parallel).

As soon as d.h.w. charging starts, a counter records the charging time. If charging is terminated before the set maximum charging time has expired, the counter will be set to zero. A new charging cycle can commence at any time.

However, if charging takes longer than the set maximum time, charging will be stopped and then locked for the same period of time. Then, charging will be resumed either until the setpoint is reached or maximum limitation terminates the charging time again.

This function can be deactivated, in which case the charging time will not be limited.

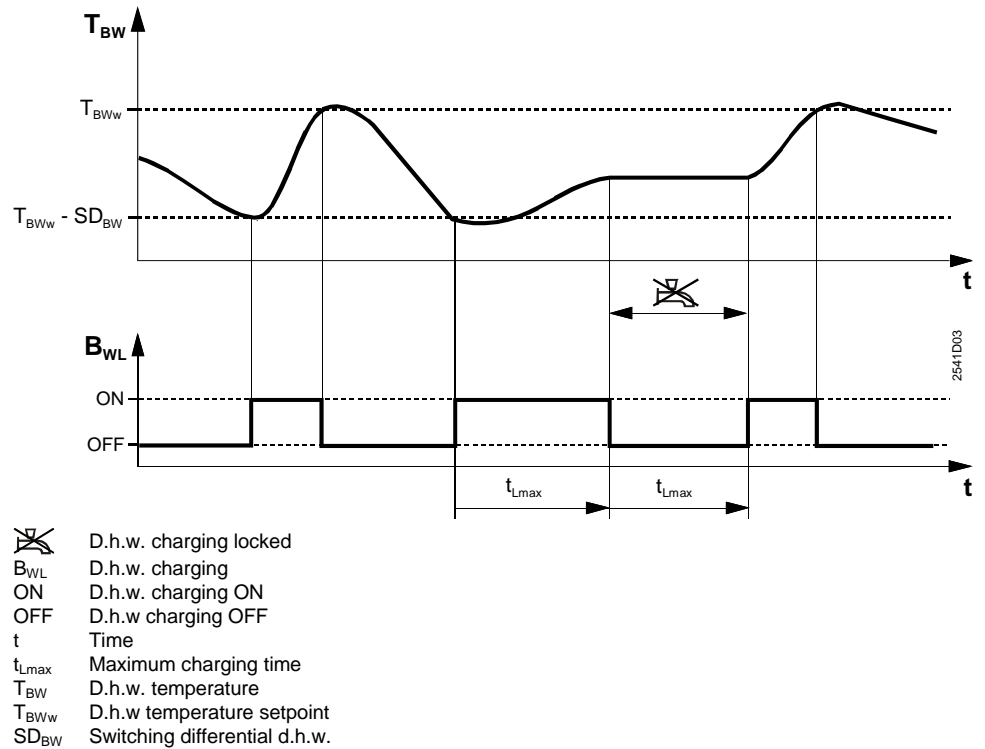

24.6 Setpoint of the legionella function

On operating line 130, the setpoint of the legionella function can be adjusted. This function raises the d.h.w. temperature periodically, thus making certain that legionella bacteria will be killed. For more information refer to chapter "28 Function block "Legionella function"".

When the function is activated, the d.h.w. temperature is raised to the adjusted legionella setpoint every Monday when d.h.w. charging is released for the first time. It is also active if a maximum charging time is set. If the legionella setpoint is not reached, the legionella function is interrupted and resumed at the end of the maximum charging time.

Preconditions for the legionella function:

- D.h.w. heating is switched on (button lit)
- The d.h.w. storage tank temperature is measured with a sensor. The legionella function cannot be provided when using a thermostat
- Charging takes place instantaneously with the heating water and not with the electric immersion heater

24.7 Forced charging

On operating line 131, it is possible to select whether or not forced charging of the d.h.w. storage tank shall take place daily when d.h.w. heating is released for the first time.

With forced charging, the d.h.w. storage tank is also charged when the d.h.w. temperature lies between the switch-on and the switch-off temperature. The switch-off point remains the same.

If d.h.w. heating is released 24 hours a day, forced charging takes place every day at midnight.

The activated legionella function also leads to forced charging.

24.8 Protection against discharging

24.8.1 Purpose

With plant types using a d.h.w. storage tank, protection against discharging is ensured during overrun of the d.h.w. charging pump. This function makes certain that the d.h.w. will not cool down again during pump overrun.

24.8.2 Mode of operation

With storage tank sensor(s)

If the flow temperature is lower than the d.h.w. storage tank temperature, pump overrun will be terminated prematurely (plant types x-1 and x-2).

If the storage tank is equipped with 2 sensors, the sensor acquiring the higher temperature is considered.

The flow temperature is acquired with sensors B2 and B3, depending on the type of plant, or obtained from the data bus (LPB) as the common flow temperature.

With thermostat(s)

If the flow temperature is lower than the d.h.w. setpoint temperature, pump overrun will be terminated prematurely (plant types x-1 and x-2).

24.8.3 Flow temperature

The flow temperature is ascertained as follows, depending on the type of plant and the bus connection:

<i>Plant type</i>	<i>Controller with no bus (LPB)</i>	<i>Controller with bus (LPB)</i>
1-1	No protection against discharging	Common flow temperature from data bus (if present), otherwise no protection against discharging
1-2	Sensor B3	Sensor B3
2-1	Sensor B2	Sensor B2
2-2	Sensor B3	Sensor B3
3-1	Sensor B2	Sensor B2
4-1	Sensor B2	Sensor B2
4-2	Sensor B3	Sensor B3
5-1	Sensor B2	Sensor B2

24.9 Manual d.h.w. charging

D.h.w. charging can be initiated manually by pressing the d.h.w. button  for 5 seconds. As a confirmation, the button will flash for 5 seconds.

Manual d.h.w. charging is also active when

- D.h.w. heating is not released
- The d.h.w. temperature lies inside the switching differential
- D.h.w. heating is switched off
- D.h.w. heating is switched off due to holiday mode
- D.h.w. heating is locked because the maximum charging time has been exceeded

Manually initiated charging of the NORMAL d.h.w. storage tank is stopped only if the d.h.w. temperature setpoint is reached, or if the maximum charging time is exceeded. After manual charging, d.h.w. heating always remains switched on, irrespective of whether or not it was switched on before the manual charging.

If d.h.w. heating shall be switched off again after the manual charging, the button must be pressed again after flashing (button extinguishes).

If the d.h.w. is heated with an electric immersion heater, manual charging is not possible.

25 Function block "3-position actuator for d.h.w."

With plant types x-2 and x-3, this function block provides 3-position control of d.h.w. heating.

25.1 Operating lines

Line	Function, parameter	Factory setting (range)	Unit
132	Flow temperature boost mixing valve / heat exchanger	10 (0...50)	°C
133	Actuator opening time	120 (10...873)	s
134	Actuator closing time	120 (10...873)	s
135	P-band of control (Xp)	32.0 (1...100)	°C
136	Integral action time of control (Tn)	120 (10...873)	s

25.2 Function

The 3-position controller is used for d.h.w. control (plant types x-2 and x-3).

25.2.1 Flow temperature boost

- Plant type x-2 (mixing valve):
For the temperature demand signal sent to the precontroller / heat source, the value of operating line 132 is added to the setpoint of d.h.w. flow sensor B3
- Plant type x-3 (heat exchanger):
For the temperature demand signal sent to the precontroller / heat source, the value of operating line 132 is added to the setpoint of d.h.w. sensor B3

25.2.2 D.h.w temperature control

The control process depends on the type of plant:

- Plant type x-2: The control mode is PI; the flow temperature is controlled by modulating the mixing valve
- Plant type x-3: The control mode is PID; the flow temperature is controlled by modulating the 2-port valve

Owing to the I-part of PI control, there is no offset. The opening and closing times of the actuator can be adjusted separately.

25.3 Pulse lock

If, during a period of time that equals five times the running time, the actuator has received only closing pulses, additional closing pulses delivered by the controller will be locked. This minimizes the strain on the actuator.

For safety reasons, the controller delivers a 1-minute closing pulse at 10-minute intervals. An opening pulse negates the pulse lock.

26 Function block "Derivative action time d.h.w. heating via heat exchanger"

With plant types x-3, this function block permits the entry of the D-part for d.h.w. control.

26.1 Operating line

<i>Line</i>	<i>Function, parameter</i>	<i>Factory setting (range)</i>	<i>Unit</i>
137	Derivative action time of control (Tv)	0 (0...255)	s

26.2 Description

The 3-position controller provides PID control. The derivative action time Tv (D-part) can be adjusted on operating line 137.

A deviation of the flow temperature from the setpoint is offset by incremental adjustment of the 2-port valve. The ideal runtime of the actuator is 10...35 seconds. In the case of d.h.w. heating via heat exchanger, it is best to set operating lines 133...137 as follows:

<i>Operating line</i>	<i>Parameter</i>	<i>Setting value</i>
133	Actuator opening time	35 s
134	Actuator closing time	35 s
135	P-band of control (Xp)	35 °C
136	Integral action time of control (Tn)	35 s
137	Derivative action time of control (Tv)	16 s

27 Function block "Multifunctional relay"

The RVL482 has a multifunctional relay whose function is to be selected on this block. This relay is also used for control of the electrical immersion heater for d.h.w. and for the CLOSE signal required for the damper actuator of the modulating burner. This means that, if the parameters of the controller are set to "Electrical actuator only" (plant type x-4), or to changeover operation, the relay cannot be used for any other functions. The settings on that block are then inactive.

27.1 Operating lines

Line	Function, parameter	Factory setting (range)	Unit
141	Function of multi-functional relay	0 (0...7)	
142	Manually ON / OFF	0 (0 / 1)	
143	Outside temperature switch, switch-off value for occupancy time	5.0 (-35...+35)	°C
144	Outside temperature switch, switch-off value for non-occupancy time	-5.0 (-35...+35)	°C
145	Outside temperature switch, switching differential	3 (1...20)	°C
146	Selection time switch	3 (1...3)	

27.2 Functions

The following functions can be assigned to the multifunctional relay:

Operating line 141	Function
0	No function
1	Outside temperature switch
2	ON / OFF according to the time switch
3	Relay energized in the event of fault
4	Relay energized during occupancy time according to the heating program (with no optimization)
5	Relay energized during occupancy time according to the heating program (including optimizations)
6	Relay energized, if there is demand for heat
7	Manually ON / OFF

27.2.1 No function

No function is assigned to the multifunctional relay.

27.2.2 Outside temperature switch

Using the outside temperature switch, any pieces of equipment can be controlled as a function of the outside temperature. This function requires an outside sensor or an outside temperature signal that is delivered via the data bus.

2 different switch-off values can be set for both the occupancy and nonoccupancy time (operating lines 143 and 144). The switch-on point lies below the switch-off point, the difference being the set switching differential (operating line 145). Depending on the setting made on operating line 146, the occupancy and nonoccupancy times may be those of

- The heating program (setting 0)
- Switching program 2 (setting 1)
- Switching program 3 (setting 2)

With plant types that have no own heating circuit (4-x and 5-x), the setting "Occupancy or nonoccupancy time according to the heating program" makes no sense, since these types of plant have no heating program. In that case, the multifunctional relay is always de-energized.

27.2.3 ON / OFF according to the time switch



The multifunctional relay is energized and deenergized according to the time switch entered on operating line 146.

With the plant types that have no own heating circuit (4-x and 5-x), the setting "According to the heating program" makes no sense, since these types of plant have no heating program. In that case, the multifunctional relay is always deenergized.

27.2.4 Relay energized in the event of fault



If, at the RVL482, an error message is present, either from the controller itself or from the data bus (LCD displays ) , the multifunctional relay will be energized. Switching on takes place with a delay of 2 minutes. When the fault is corrected, that is, when the error message is no longer present, the relay will be deenergized with no delay.

27.2.5 Relay energized during occupancy time

If the own heating circuit is maintained at operational level  – independent of the operating mode – the multifunctional relay is energized. In operating mode ^{Auto} , no consideration is given to optimum start / stop control.

With the plant types that have no own heating circuit (4-x and 5-x), the setting "Relay energized during occupancy time" makes no sense. In that case, the multifunctional relay is always deenergized.

27.2.6 Relay energized during occupancy time (including optimizations)

If the own heating circuit is maintained at operational level  – independent of the operating mode – the multifunctional relay is energized (LCD displays ). In operating mode ^{Auto} , consideration is given to optimum start / stop control.

With the plant types that have no own heating circuit (4-x and 5-x), the setting "Relay energized during occupancy time" makes no sense. In that case, the multifunctional relay is always deenergized.



27.2.7 Relay energized, if there is demand for heat

If the own heating circuit or the d.h.w. circuit calls for heat, the multifunctional relay will be energized.

In interconnected plants, the relay is energized when the controller receives a demand for heat.

27.2.8 Manually ON / OFF

On operating line 142, the multifunctional relay can be manually energized and deenergized with the setting buttons.

<i>Press button</i>	<i>Effect</i>
	Multifunctional relay will be energized
	Multifunctional relay will be de-energized

28 Function block "Legionella function"

When using d.h.w. systems with storage tank, this function prevents legionella bacteria. This is accomplished by periodically raising the d.h.w. temperature to a higher level.

28.1 Operating lines

<i>Line</i>	<i>Function, parameter</i>	<i>Factory setting (range)</i>	<i>Unit</i>
147	Periodicity of the legionella function	1 (0...7)	
148	Point in time of legionella function	05:00 (00:00...24.00)	hh:mm
149	Dwelling time at the legionella setpoint	30 (0...360)	min
150	Circulating pump operation during the legionella function	1 (0 / 1)	

28.1.1 Periodicity of the legionella function

Periodicity can be selected on operating line 147.

- When choosing setting 0, the d.h.w. temperature will be raised to the legionella setpoint once a day
- When choosing setting 1 to 7, the d.h.w. temperature will be raised to the legionella setpoint once a week. With setting 1, the d.h.w. temperature will be raised on Monday; with setting 2 on Tuesday, etc.

28.1.2 Point in time of the legionella function

The time when the legionella function shall be started can be set on operating line 148.

28.1.3 Dwelling time at the legionella setpoint

On operating line 149, it will be defined for what period of time the actual value of the d.h.w. temperature will have to lie above the legionella setpoint (operating line 130) for the function to be satisfied.

28.1.4 Circulating pump operation during the legionella function

On operating line 150, it is possible to select whether the legionella function shall act on the d.h.w. circulating pump.

- When choosing setting 0, the legionella function will not act on the d.h.w. circulating pump
- When choosing setting 1, the legionella function will act on the d.h.w. circulating pump

28.2 Mode of operation

Preconditions for the legionella function:

- The d.h.w. storage tank temperature is acquired with 1 or 2 sensors (the legionella function cannot be provided when using thermostats)
- Charging takes place instantaneously with the heating water and not with the electric immersion heater
- A legionella setpoint is adjusted
- D.h.w. heating is switched on (button  lit)

If the criteria of periodicity and time are satisfied, the legionella function will be released. Release of the legionella function means that the d.h.w. temperature setpoint will be raised to the level of the legionella setpoint and that forced charging will be triggered. If d.h.w. heating is switched off, or the holiday function or operating mode changeover active, the legionella function will be released, but not setpoint boost. On completion of the overriding function, d.h.w. charging to the legionella setpoint will be triggered since release of the legionella function will be maintained.

The behavior of the legionella function as a function of the d.h.w. temperature is as follows:

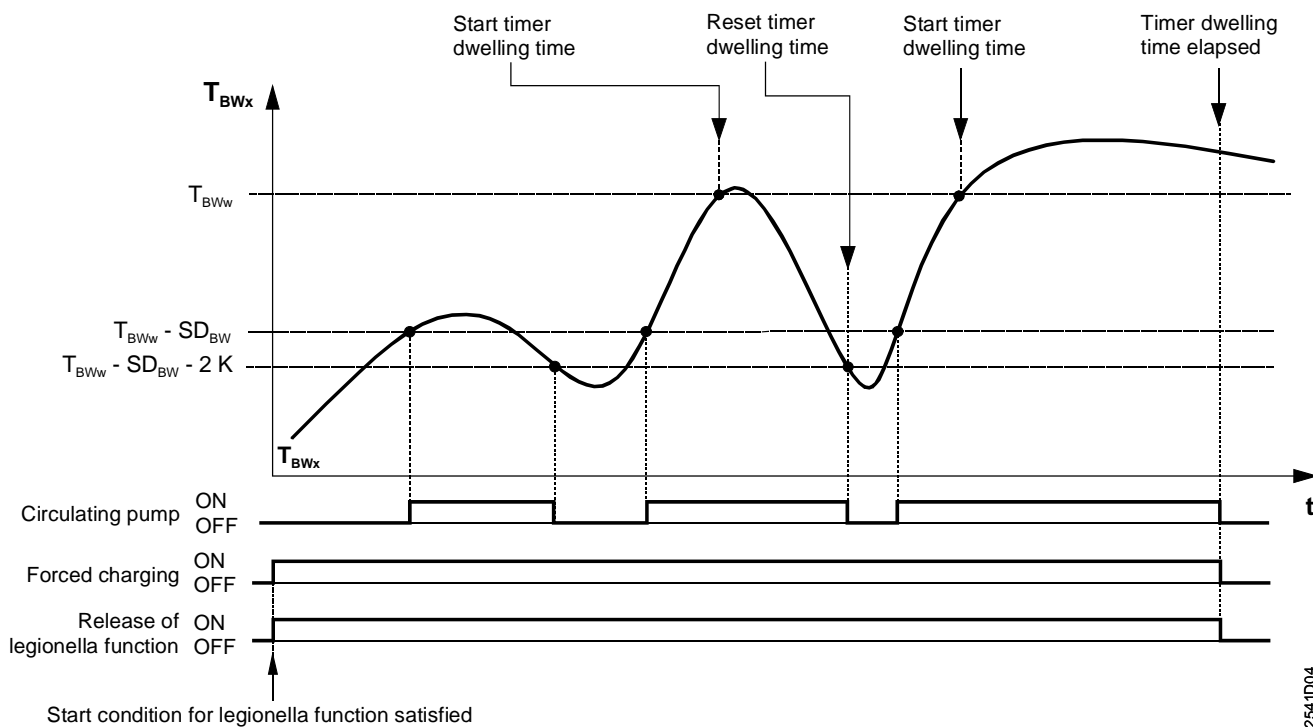

T_{BWx}	D.h.w. temperature
T_{BWw}	D.h.w. temperature setpoint
SD_{BW}	Switching differential of d.h.w. charging
t	Time

It is also active if a maximum d.h.w. charging time is set. If the legionella setpoint is not reached, the legionella function is interrupted and resumed on completion of the maximum charging time.

2541D04

29 Function block "Switching program 3"

Switching program 3 of this function block can be used for one or several of the following functions:

- As a time switch program for the circulating pump (operating line 122)
- As a time switch program for the multifunctional relay (operating lines 141 and 146)

29.1 Operating lines

<i>Line</i>	<i>Function, parameter</i>	<i>Factory setting (range)</i>	<i>Unit</i>
151	Weekday (for switching program 3)	1-7 (1...7 / 1-7)	
152	Start of first ON period	06:00 (--:-- / 00:00...24:00)	hh:mm
153	End of first ON period	22:00 (--:-- / 00:00...24:00)	hh:mm
154	Start of second ON period	--:-- (--:-- / 00:00...24:00)	hh:mm
155	End of second ON period	--:-- (--:-- / 00:00...24:00)	hh:mm
156	Start of third ON period	--:-- (--:-- / 00:00...24:00)	hh:mm
157	End of third ON period	--:-- (--:-- / 00:00...24:00)	hh:mm

29.2 Description

Switching program 3 of the RVL482 affords a maximum of 3 on periods per day; also, every day of week may have different on periods.

As with the heating program, it is not the switching times that are entered, but periods of time during which the program or the controlled function shall be active.

Using setting "1-7" on operating line 151, it is possible to enter a heating program that applies to all days of the week. This simplifies the settings: If the weekend times differ, enter the times for the entire week first, and then change days 6 and 7 as required.

The entries are sorted and overlapping ON periods combined.

30 Function block "Service functions and general settings"

This function block is used to combine various displays and setting functions that are of assistance in connection with commissioning and service work. In addition, a number of extra functions are performed.

The service functions are independent of the type of plant.

30.1 Operating lines

<i>Line</i>	<i>Function, parameter</i>	<i>Factory setting (range)</i>	<i>Unit</i>
161	Outside temperature simulation	--.- (--.- / -50...+50)	°C
162	Relay test	0 (0...13)	
163	Sensor test	Display function	
164	Test of H-contacts	Display function	
165	Flow temperature setpoint	Display function	
166	Resulting heating curve	Display function	
167	Outside temperature for frost protection for the plant	2.0 (--.- / 0...25)	°C
168	Flow temperature setpoint for frost protection for the plant	15 (0...140)	°C
169	Device number	0 (0...16)	
170	Segment number	0 (0...14)	
171	Flow alarm	--:-- (--:-- / 1:00...10:00)	hh:mm
172	Operating mode when terminals H1-M are bridged	0 (0...9)	
173	Gain of locking signal	100 (0...200)	%
174	Pump overrun time	6 (0...40)	min
175	Pump kick	0 (0 / 1)	
176	Winter- / summertime changeover	25.03 (01.01...31.12)	dd:MM
177	Summer- / wintertime changeover	25.10 (01.01...31.12)	dd:MM
178	Clock mode	0 (0...3)	
179	Bus power supply	A (0 / A)	
180	Outside temperature source	A (A / 00.01...14.16)	
182	DC 0...10 V heat demand signal U1	130 (30...130)	°C
183	DC 0...10 V heat demand signal U2	130 (30...130)	°C

30.2 Display functions

30.2.1 Flow temperature setpoint

Displayed is the current flow temperature setpoint which is made up of the following variables:

- Flow temperature setpoint as a function of the composite outside temperature and the heating curve
- Position of the knob for room temperature readjustments
- Parallel displacement of the heating curve (setting on operating line 72)

With demand-compensated control (plant types 4-x and 5-x), the display shows ---.

Generation of the flow temperature setpoint

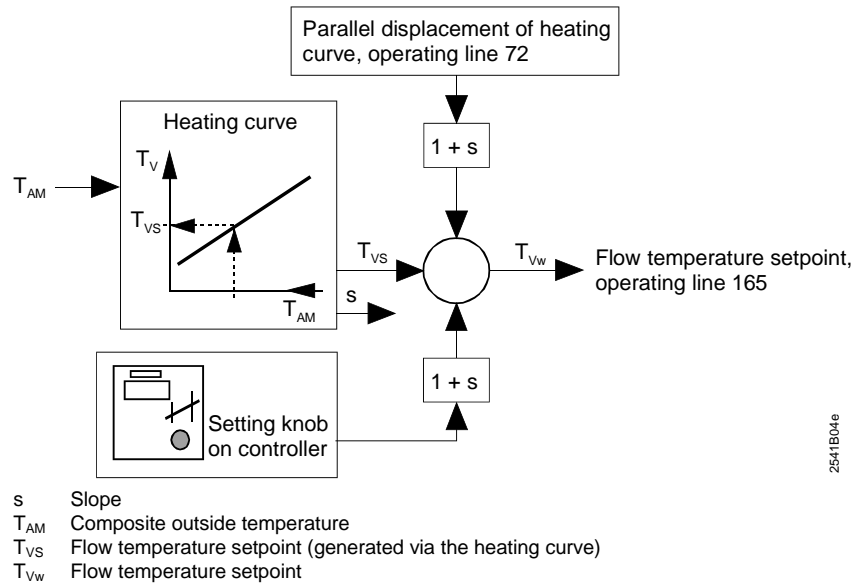

2541B04e

30.2.2 Heating curve

The display shows the current heating curve which is made up of the following variables:

- Basic setting made with the little bar or setting made on operating lines 14 and 15
- Position of the knob for room temperature readjustments
- Parallel displacement of the heating curve (setting on operating line 72)

The display also shows the 2 flow temperature setpoints:

- TV1: Current setpoint at an outside temperature of +15 °C
- TV2: Current setpoint at an outside temperature of -5 °C

With demand-compensated control (plant types 4-x and 5-x), the display shows --- ---.

Display of heating curve data

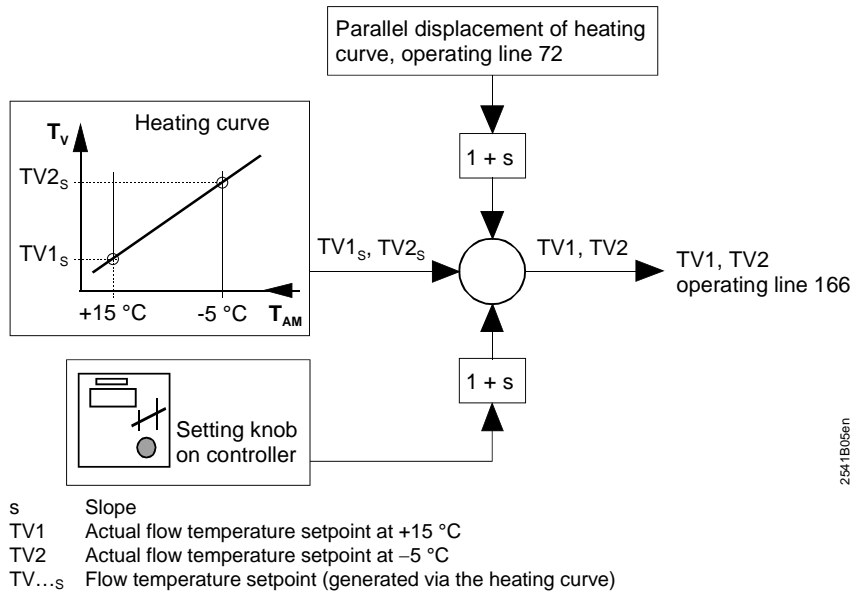

2541B05en

30.3 Commissioning aids

30.3.1 Simulation of the outside temperature

To facilitate commissioning and fault tracing, outside temperatures in the range -50 to +50 °C can be simulated. This simulation has an effect on the actual, the composite and the attenuated outside temperature.

$$\text{Simulated } T_A = \text{actual } T_A = \text{composite } T_A = \text{attenuated } T_A$$

During the temperature simulation, the actual outside temperature (as acquired by the sensor or via LPB) will be overridden.

When the simulation is terminated, the actual outside temperature will gradually readjust the composite and the attenuated temperatures to their correct values. The simulation of the outside temperature therefore causes a reset of the attenuated and the composite outside temperatures.

There are 3 choices to terminate the simulation:



- Entry of --.-
- Leaving the setting level by pressing the Info button or any of the operating mode buttons
- Automatically after 30 minutes

30.3.2 Relay test

The 8 output relays can be individually energized. Depending on the type of plant, the following codings apply:

<i>Input</i>	<i>Reaction of the relay</i>
0	Normal operation
1	All contacts open
2	Burner stage 1 ON (K4)
3	Burner stages 1 ON (K4) and 2 ON / damper actuator of the modulating burner OPEN (K5)
4	Circulating pump / bypass pump ON (M1)
5	Charging pump ON (M3)
6	Heating circuit mixing valve OPEN (Y1)
7	Heating circuit mixing valve CLOSED (Y2)
8	Heating circuit pump ON (M2)
9	Boiler pump / circulating pump ON (M4)
10	Multifunctional relay energized / damper actuator of the modulating burner CLOSED (K6)
11	D.h.w. valve / return mixing valve OPEN (Y7)
12	D.h.w. valve / return mixing valve CLOSED (Y8)
13	Collector pump ON (M5)

There are 4 choices to terminate the relay test:

- Entry of 0 on the operating line
- Leaving the setting level by pressing button  or 
- Leaving the setting level by pressing the Info button or any of the operating mode buttons
- Automatically after 30 minutes

30.3.3 Sensor test

The connected sensors can be checked on operating line 163. In addition, if available, the current setpoints and limit values are displayed.

On the display, the current setpoints are identified by SET, the actual values by ACTUAL (also refer to chapter "36 Handling").

The 9 temperatures can be called up by entering 0...8:

<i>Input</i>	<i>Display SET</i>	<i>Display ACTUAL</i>
0	No display	Actual value of outside sensor at terminal B9. If the outside temperature is delivered via the data bus, the display shows ---
1	Flow temperature setpoint. If there is no demand for heat, the display shows ---	Actual value of flow temperature sensor at terminal B1



<i>Input</i>	<i>Display SET</i>	<i>Display ACTUAL</i>
2	Setpoint of room temperature. With the plant types with no heating circuit, the display shows ---	Actual value of room temperature sensor at terminal B5
3	Setpoint of room temperature. With the plant types with no rooms, the display shows ---	Actual value of room unit sensor at terminal A6
4	Minimum limit value of the return temperature. If no return temperature limitation is used, the display shows ---	Actual value of return temperature sensor at terminal B7. If the return temperature is delivered via data bus, the display shows ---
5	Maximum limit value of the return temperature. If no return temperature limitation is used, the display shows ---	Actual value of return temperature sensor at terminal B7.
6	Setpoint of the d.h.w. flow temperature. With plant types with no d.h.w. flow or if there is no demand for heat, the display shows ---	Actual value of d.h.w. flow temperature sensor at terminal B3
7	Setpoint of the d.h.w. temperature. With plant types with no storage tank, the display shows ---	Actual value of storage tank temperature sensor / thermostat at terminal B31
8	Setpoint of the d.h.w. temperature. With plant types with no storage tank, the display shows ---	Actual value of storage tank temperature sensor / thermostat at terminal B32
9	Setpoint of the boiler temperature (switch-off point). If there is no demand for heat, the display shows ---	Actual value of boiler temperature sensor at terminal B2.
A	Actual value storage tank temperature B32	Actual value of the temperature at the collector, terminal B6

Faults in the measuring circuits are displayed as follows:

<i>Display</i>	<i>Sensor</i>	<i>Control thermostat</i>
000	Short-circuit	Contact closed
- - -	Open-circuit	Contact open

30.3.4 Test of contacts H

The connected contacts H can be checked on operating line 164. It is always the current status that is indicated (contact open, contact closed).

The contacts can be individually selected by pressing  and .

<i>Input</i>	<i>Contact</i>
H1	Overriding the operating mode (contact H1)
H2	Manually generated heat demand (contact H2)

The contact's status is displayed as follows:

<i>Display</i>	<i>Contact state</i>
000	Contact closed
- - -	Contact open

30.4 Auxiliary functions

30.4.1 Frost protection for the plant

The plant can be protected against frost. For that, the controller and the heat source must be ready to operate (mains voltage present!).

The following settings are required:

- The outside temperature at which frost protection shall respond
- The minimum flow temperature that shall be maintained by the frost protection function

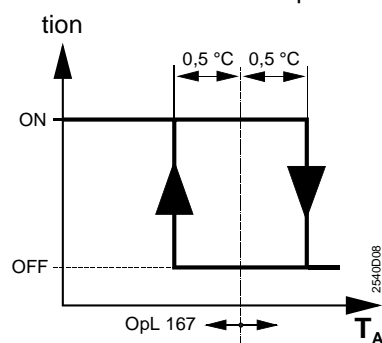

OpL167 Operating line 167
TA Outside temperature
OFF Frost protection OFF
ON Frost protection ON

Plant types 1-x, 2-x, 3-x

If the outside temperature falls below the limit value (setting on operating line 167 minus 0.5 °C), the RVL482 will switch the heating circuit pump M2 on and maintain the flow temperature at the adjusted minimum level. A respective heat demand is sent to the heat generating equipment. The control is switched off when the outside temperature exceeds the limit value by 0.5 °C.

Plant types 4-x, 5-x

If the outside temperature falls below the limit value (setting on operating line 167 minus 0.5 °C), the RVL482 will switch the circulating pump M1 on and maintain the boiler temperature at the selected minimum level (lowest possible level is the minimum limit value). The control is switched off when the outside temperature exceeds the limit value by 0.5 °C.

Frost protection for the plant can be deactivated.

30.4.2 Flow alarm

The flow alarm triggers an error message if the flow temperature or boiler temperature (depending on the type of plant) does not reach the required setpoint band (setpoint \pm a defined switching differential) within a defined period of time – provided there is a demand for heat. This period of time can be set on operating line 171.

- Plant types 1-x, 2-x, 3-x: Decisive is the temperature acquired by sensor B1. The switching differential corresponds to the neutral zone (± 1 °C)
- Plant types 4-x and 5-x: Decisive is the temperature acquired by sensor B2. The switching differential corresponds to the set boiler switching differential ($\pm 0.5 \times SD$; operating line 94)

The display shows the error message as , and error code 120 on operating line 50 gives more detailed information.

The flow alarm can be deactivated by entering --:--.

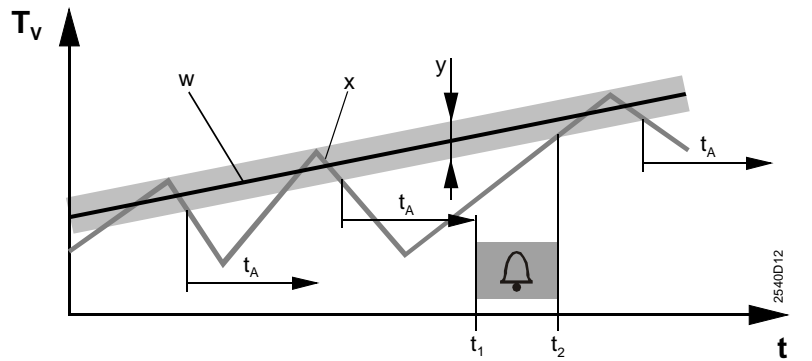

t	Time	T _V	Flow or boiler temperature
t ₁	Start of error display	w	Setpoint
t ₂	End of error display	x	Actual value
t _A	Waiting time (set on operating line 171)	Y	Setpoint band

- At t₁, an error message is triggered; during the period of time t_A (set on operating line 171), the actual value stayed below the setpoint band “y”
- At t₂, the error message is reset; the actual value “x” has reached the setpoint band “y”

30.4.3 Manual overriding of operating mode (contact H1)

Using a simple remote operation facility, the operating mode of the heating circuit and that of d.h.w. can be overridden. This is accomplished by bridging terminals H1–M. It is possible to select the operating mode to be used when H1–M are bridged:

Setting	Operating mode heating circuit	Operating mode d.h.w.
0	⏸ Protection	OFF
1	Auto ⏴ AUTO	OFF
2	☾ REDUCED	OFF
3	☀ NORMAL	OFF
4	⏸ Protection	ON
5	Auto ⏴ AUTO	ON
6	☾ REDUCED	ON
7	☀ NORMAL	ON
8	Auto ⏴ AUTO	continuously (24 hours a day)
9	☀ NORMAL	continuously (24 hours a day)

As long as this function is active, the LED of the respective operating mode button flashes at a low frequency (approx. 0.5 Hz). The buttons themselves are however inoperable.

Once this function is deactivated, the RVL482 will resume the operating mode previously selected.

With plant types 4–x and 5–x, contact H1 only acts on the d.h.w. circuit.

30.4.4 Pump overrun

To prevent heat from building up, a common pump overrun time can be set for all pumps associated with the controller (with the exception of the circulating pump) on operating line 174. In that case, the pumps overrun for the set period of time.

D.h.w. discharging protection has priority over pump overrun.

In interconnected plants, the time set also affects the forced signals that a boiler can deliver to ensure overtemperature protection.

For detailed information, refer to section "14.7.2 Plant types 3–x and 5–x".

30.4.5 Pump kick

To prevent pump seizing during longer off periods (e.g. in the summer), it is possible to activate periodic pump runs: The input is either 0 or 1:

0 = no periodic pump kick

1 = periodic pump kick activated

If the pump kick is activated, all pumps run for 30 seconds, one after the other, every Friday morning at 10:00, independent of all other functions and settings.

30.4.6 Winter- / summertime changeover

The change from wintertime to summertime, and vice versa, is made automatically. If international regulations change, the dates need to be reentered. The entry to be made is the earliest possible changeover date. The weekday on which changeover occurs is always a Sunday.

Example

If the start of summertime is given as "The last Sunday in March", the earliest possible changeover date is March 25. The date to be entered on operating line 176 is then 25.03.

If no summer- / wintertime changeover is required, the 2 dates are to be set such that they coincide.

30.4.7 Gain of locking signal

Fundamentals

The functions "Maintained boiler return temperature", "Protective boiler startup" and "D.h.w. priority" use locking signals that are sent to the heat exchangers and loads. With the heat exchanger and load controllers, using operating line 173 (Amplification of locking signal), it is possible to set to what degree they shall respond to locking signals. This locking signal gain is adjustable from 0 % to 200 %.

<i>Setting</i>	<i>Response</i>
0 %	Locking signal will be ignored
100 %	Locking signal will be adopted 1-to-1
200 %	Locking signal will be doubled

There are 2 types of locking signals:

- Uncritical locking signals
- Critical locking signals

The response of the loads depends on the kind of load.

Uncritical locking signals

Uncritical locking signals are generated in connection with the d.h.w. priority (absolute and shifting) and only act on the heating circuits.

The response of the heating circuit depends on the type of heating circuit:

- Heating circuit with mixing valve:
In the heating circuit, the flow temperature setpoint will be reduced as a function of the set locking signal gain. The mixing valve closes.
- Heating circuit with pump:
In case of a defined value of the uncritical locking signal, the heating circuit pump will be deactivated, independent of the set locking signal gain.

Critical locking signals

Critical locking signals are generated by the boiler temperature controller during protective boiler startup and during minimum limitation of the boiler return temperature. If the boiler temperature controller is located in segment 0, the critical locking signal will be sent to all loads and heat exchangers in the bus network and – if present – to its own heating and d.h.w. circuit. If the boiler temperature controller is in segment 1...14, it will deliver the critical locking signal only to all loads in the same segment and – if present – to its own heating and d.h.w. circuit.

Minimum limitation of the return temperature can also be provided locally by a controller with plant type 1–x. In that case, the critical locking signal only acts inside the controller and is only delivered to the own heating and d.h.w. circuit.

With regard to the response of the consumers and heat converters, there are 2 choices:

- Heat converters and consumers with mixing valves:
The flow temperature setpoint will be reduced as a function of the set locking signal gain. Heat exchanger and load close their mixing valve.
- Consumers with pump circuit:
When a defined value of the critical locking signal is reached, the pump will be deactivated, independent of the set locking signal gain

30.5 Entries for LPB

30.5.1 Source of time of day

Depending on the master clock, different sources for the time of day can be used. The source must be entered with setting 0...3 on the RVL482, on operating line 178:

0 = Autonomous clock in the RVL482

1 = Time of day from the bus; clock (slave) with no remote readjustment

2 = Time of day from the bus; clock (slave) with remote readjustment

3 = Time of day from the bus; central clock (master)

The effect of the individual entries is as follows:

Input	Effect	Diagram
0	<ul style="list-style-type: none"> • The time of day on the controller can be readjusted • The controller's time of day is not matched to the system time 	
1	<ul style="list-style-type: none"> • The time of day on the controller cannot be readjusted • The controller's time of day is automatically and continually matched to the system time 	
2	<ul style="list-style-type: none"> • The time of day on the controller can be readjusted and, at the same time, readjusts the system time since the change is adopted by the master • The controller's time of day is nevertheless automatically and continually matched to the system time 	
3	<ul style="list-style-type: none"> • The time of day on the controller can be readjusted and, at the same time, readjusts the system time • The controller time is used as a pre-setting for the system 	

In each system, only one controller may be used as a master. If several controllers are set as masters, an error message will be delivered (error code 100).

30.5.2 Outside temperature source

If, in interconnected plants, the outside temperature is delivered via the bus, the temperature source can be addressed either automatically or directly (operating line 180).

- Automatic addressing:

<i>Display, entry</i>		<i>Explanation</i>
SET	A	(For automatic addressing)
ACTUAL	xx.yy	Display of source address selected by automatic addressing: xx = segment number yy = device number

- Direct addressing:

To be entered is the source address: xx.yy

xx = Segment number

yy = Device number

If the controller is operated autonomously (with no bus), there will be no display and no entry can be made.

If the controller is used in an interconnected plant **and** if it has its own outside sensor, it is not possible to enter an address (if an entry is made, the display shows OFF). In that case, the controller always uses the outside temperature signal delivered by its own sensor. The address displayed is its own.

For detailed information about addressing of the wind speed source, refer to Data Sheet N2030.

30.5.3 Addressing the devices

Each device connected to the data bus (LPB) requires an address. This address is comprised of a device number (1...16, operating line 169) and a segment number (0...14, operating line 170).

In an interconnected plant, each address may be assigned only once. If this is not observed, proper functioning of the entire plant cannot be ensured. In that case, an error message will be generated (error code 82).

If the controller is operated autonomously (with no bus), the device number must be set to zero.

Since the device address is also associated with control processes, it is not possible to use all possible device addresses in all types of plant:

<i>Plant type</i>	<i>G = 0 S = any (no bus)</i>	<i>G = 1 S = 0...14</i>	<i>G = 2...16 S = any</i>
1-x	Permitted	Permitted	Permitted
2-x	Permitted	Permitted	Not permitted
3-x	Permitted	Permitted	Not permitted
4-x	Not permitted	Permitted	Permitted *)
5-x	Not permitted	Permitted	Permitted

G = Device number

S = Segment number

*) Settings 2 and 3 of operating line 99 (operating mode pump M1) are not permitted here. An error message will appear (error code 140).

If an inadmissible address has been entered, an error message will appear (error code 140).

For detailed information about the addressing of devices, refer to Data Sheet N2030.

30.5.4 Bus power supply

In interconnected plants with a maximum of 16 controllers, the bus power supply may be decentralized, that is, power may be supplied via each connected device. If a plant contains more than 16 devices, a central bus power supply is mandatory.

On each connected device, it is then necessary to set whether the data bus is powered centrally or decentrally by each controller.

With the RVL482, this setting is made on operating line 179. The display shows the current setting as SET and the current bus power supply status as actual.

Display		Bus power supply
SET	0	Bus power supply is central (no power supply via the controller)
SET	A	Bus power supply is decentral via the controller
ACTUAL	0	Presently no bus power supply available
ACTUAL	1	Bus power supply presently available

The word BUS appears on the display only when the bus address is valid and when bus power supply is available. This means the display indicates whether or not data traffic via the data bus is possible.

30.5.5 Bus loading number

The bus loading figure E for the LPB of the RVL482 is 9. The total of all E-numbers of the devices connected to the same bus may not exceed the limit of 300.

30.6 Heat demand inputs DC 0...10 V

Operating lines 182 and 183 are described in section "32.3.2 Input U1 and section "32.3.3 Input U2 ".

31 Function block "Contact H2"

This function block is used to enter the plant section on which the heat demand of contact H2 acts.

31.1 Operating lines

<i>Line</i>	<i>Function, parameter</i>	<i>Factory setting (range)</i>	<i>Unit</i>
184	Function when terminals H2–M are bridged	0 (0 / 1)	

31.2 Description

Flow / boiler control can be overridden by using a simple remote operation facility. This is accomplished by bridging terminals H2–M.

With plant types 1–x, 2–x, and 3–x – using operating line 184 – it is possible to select where the heat demand signal shall be passed:

Setting 0 = Heat demand signal to the heat source

Setting 1 = Heat demand signal to the heating circuit

With plant types 4–x and 5–x, the heat demand signal is always passed to the heat source.

On operating line 185, it is possible to adjust the setpoint required when bridging H2–M:

0 = constant setpoint of flow / boiler; the RVL482 maintains this fixed setpoint.

1 = minimum setpoint of flow / boiler; the RVL482 maintains at least this minimum setpoint, even if other heat demand signals call for a lower setpoint.

The setpoint can be adjusted on operating line 186.

As long as this function is active, the LED of the respective operating mode button flashes at high frequency (approx. 2 Hz).

When contact H1 is closed, contact H2 is inactive, that is, contact H1 is given priority.

If contact H2 acts on a heating circuit, it might not be possible to maintain the temperature demanded by contact H2, depending on the type of d.h.w. priority.

32 Function block "External inputs"

This function block handles the external inputs and some of the display functions.

32.1 Operating lines

Line	Function, parameter	Factory setting (range)	Unit
185	Impact when connection terminals H2–M are bridged	0 (0 / 1)	
186	Temperature demand when connection terminals H2–M are bridged	70 (0...140)	°C
187	Values of voltage inputs	Display function	
188	Function of voltage input 1 (U1)	0 (0...2)	
189	Impact of solar radiation	0 (0...20)	°C
190	Source of solar radiation	A (A / 00.01...14.16)	
191	Function of voltage input 2 (U2)	0 (0...2)	
192	Effect of wind speed	0 (0...20)	°C
193	Source of wind speed	A (A / 00.01...14.16)	
194	Hours run counter	Display function	
195	Controller's software version	Display function	
196	Identification code of room unit	Display function	

32.2 Contact H2

For details, refer to chapter "31 Function block "Contact H2"".

32.3 Voltage inputs

32.3.1 Display

On operating line 187, the following values of the voltage inputs can be called up:

- 0 = Solar radiation in W/m²
- 1 = Wind speed in m/s
- 2 = Heat demand at input U1 in °C
- 3 = Heat demand at input U2 in °C

32.3.2 Input U1

On operating line 188, the function of voltage input U1 can be selected.

- 0 = Input is not used
- 1 = Connection of QLS60 solar impact sensor
- 2 = Heat demand signal DC 0...10 V

Solar radiation

If a solar sensor is used, it can be connected to its own controller or, in the case of interconnected plant, to some other controller. The solar radiation signal can be delivered via the data bus (LPB).

The impact of solar radiation on the heating circuit is to be set on operating line 189. Entry of between 0 and 20 °C corresponds to the room setpoint reduction with a solar radiation of 1000 W/m². For the impact of the room setpoint reduction on the control, refer to section "12.7 Generation of setpoint".

If, in interconnected plant, the solar radiation signal is delivered via the data bus, the temperature source can be addressed either automatically or directly (operating line 190).

- Automatic addressing:

Display, entry		Explanation
SET	A	(For automatic addressing)
ACTUAL	xx.yy	Display of source address selected by automatic addressing: xx = segment number yy = device number

- Direct addressing:
To be entered is the source address: xx.yy
xx = segment number
yy = device number

If the controller is operated autonomously (with no bus), there will be no display and no entry can be made.

If the controller is used in an interconnected plant **and** if its operating line 188 is set to solar sensor, it is not possible to enter an address (if an entry is made, the display shows OFF). In that case, the controller always uses the solar radiation signal delivered by its own sensor. The address displayed is its own.

For detailed information about addressing of the wind speed source, refer to Data Sheet N2030.

When connected to the RVL482, the solar sensor must be powered by an external source. For detailed information, refer to the Data Sheet of the solar sensor.

Heat demand signal U1

A heat demand signal can be delivered to the controller via the DC 0...10 V voltage input U1. The temperature value of the heat demand signal corresponding to DC 10 V can be entered on operating line 182. With plant types 1-x, this demand signal is delivered via the data bus to the precontroller and, with plant types 2-x, 3-x, 4-x and 5-x, to the boiler.

Relationship of voltage signal:

<i>Voltage</i>	<i>Temperature, when operating line 182 = 80 °C</i>	<i>Temperature, when operating line 182 = 130 °C</i>
DC 0 V	0 °C	0 °C
DC 5 V	40 °C	65 °C
DC 10 V	80 °C	130 °C

Signals below DC 0.4 V are interpreted by the controller as "no demand".

If 2 heat demand signals are used, the controller makes a maximum selection.

32.3.3 Input U2

On operating line 191, the function of voltage input U2 can be selected.

0 = Input not used

1 = Connection of a wind sensor (commercially available, DC 0...10 V)

2 = Heat demand signal DC 0...10 V

Wind speed

If a wind sensor is used, it can be connected to its own controller or, in interconnected plant, to some other controller. The wind speed signal can be delivered via the data bus (LPB).

The impact of the wind speed on the heating circuit is to be set on operating line 192. Entry of between 0 and 20 °C corresponds to the room setpoint boost at a room setpoint of 20 °C, a wind speed of 20 m/s and an outside temperature of -5 °C. For the impact of setpoint changes on the control, refer to section "12.7 Generation of setpoint". In addition to the room setpoint change, the ECO heating limits are also shifted upwards and downwards.

If, in interconnected plant, the wind speed signal is delivered via the bus, the source can be addressed either automatically or directly (operating line 193).

- Automatic addressing:

<i>Display, entry</i>		<i>Explanation</i>
SET	A	(For automatic addressing)
ACTUAL	xx.yy	Display of source address selected by automatic addressing: xx = segment number yy = device number

- Direct addressing:
To be entered is the source address: xx.yy
xx = segment number
yy = device number

If the controller is operated autonomously (with no bus), there will be no display and no entry can be made.

If the controller is used in interconnected plant **and** if its operating line 191 is set to wind effect sensor, it is not possible to enter an address (if an entry is made, the display shows OFF). In that case, the controller always uses the wind speed signal delivered by its own sensor. The address displayed is its own.

For detailed information about addressing of the wind speed source, refer to data sheet N2030.

When connected to the RVL482, the wind sensor must be powered by an external source. For more detailed information, refer to the data sheet of the wind sensor.

Heat demand signal U2

A heat demand signal can be delivered to the controller via the DC 0...10 V voltage input U2. The temperature value of the heat demand signal corresponding to DC 10 V can be set on operating line 183. With plant types 1-x, this heat demand signal is delivered to the precontroller (via the data bus) and, with plant types 2-x, 3-x, 4-x and 5-x, to the boiler.

Relationship of voltage signal:

<i>Voltage</i>	<i>Temperature, when operating line 183 = 80 °C</i>	<i>Temperature, when operating line 183 = 130 °C</i>
DC 0 V	0 °C	0 °C
DC 5 V	40 °C	65 °C
DC 10 V	80 °C	130 °C

Signals below DC 0.4 V are interpreted by the controller as "no demand".

If 2 heat demand signals are used, the controller makes a maximum selection.

32.4 Hours run counter

The number of controller operating hours is displayed. Whenever operating voltage is present, the RVL482 counts the hours.

The maximum reading is limited to 500,000 hours (57 years).

32.5 Software version

The controller displays the software version in use.

32.6 Identification number of room unit

Based on the number shown on the display, the type of room unit used can be identified.

The types of room units that can currently be used with the RVL482 carry the following numbers:

82 = QAW50

83 = QAW70

The RVL482 ignores room units that cannot be used (e.g. QAW20) and generates an error message (error code 62).

33 Function block "D.h.w. solar charging"

The RVL482 supports solar d.h.w. heating with the d.h.w. plant types 1, 2 and 4. The function is activated on operating line 126 by selecting the d.h.w. temperature sensor. This always enables solar d.h.w. charging, carried out via the collector pump based on the temperature differential between d.h.w. storage tank and collector temperature. The lower storage tank sensor B32 is used for solar charging control. If the sensor is missing, the upper storage tank sensor B31 is used automatically (if available). Symbol ☀ on the displays indicates solar d.h.w. charging.

Note

In the event of boiler support for solar d.h.w. heating, select setting 4 (1 sensor with solar) on operating line 126 and still connect both storage tank sensors. This results in solar d.h.w. charging based on the lower sensor (B32), and boiler support via the upper sensor (B31). As a result, only the upper portion of the storage tank is charged via boiler.

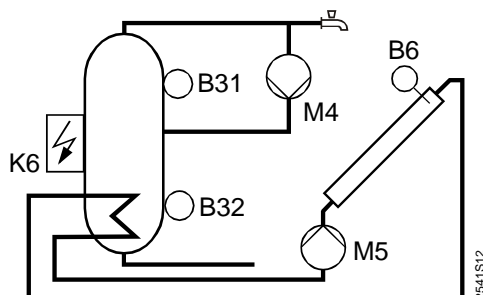

- B31 Storage tank sensor 1
- B32 Storage tank sensor2
- B6 Collector sensor
- K6 Electric immersion
- M4 Circulation pump
- M5 Collector pump

33.1 Operating lines

Line	Function, parameter	Factory setting (range)	Unit
201	Temperature differential ON solar	8 (0...40)	°C
202	Temperature differential OFF solar	4 (0...40)	°C
203	Collector frost protection	--- (--- / -20...5)	°C
204	Collector over temperature protection	105 (--- / 30...260)	°C
205	Evaporation heat carrier	140 (--- / 60...260)	°C
206	D.h.w. charging temperature maximum limitation	80 (8...100)	°C
207	D.h.w. storage tank temperature maximum limitation	90 (8...100)	°C
208	Collector start function gradient	--- (--- / 1...20)	min/°C

33.2 Functions

33.2.1 Temperature differential ON/OFF solar

Operating lines 201 and 202 allow for setting the temperature differential to enable or disable solar d.h.w. charging.

A sufficiently large temperature differential between collector and d.h.w. storage tank must exist for storage tank charging; in addition, the collector must have reached a minimum charging temperature.

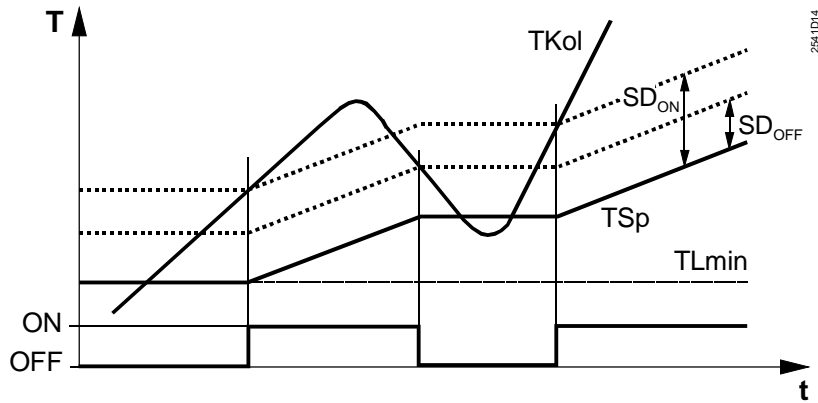

TKol Collector temperature
 ON/OFF Collector pump
 SD_{ON} Temperature differential ON
 SD_{OFF} Temperature differential OFF
 TSp Storage tank temperature
 TLmin Minimum charging temperature
 T Temperature
 t Time

- The storage tank is charged if the collector temperature exceeds the current storage temperature by the switch-on differential:
 $TKol > TSp + SD_{ON}$
- Storage tank charging is stopped if the collector temperature drops below the temperature differential:
 $TKol < TSp + SD_{OFF}$

33.2.2 Minimum charging temperature

The collector pump is commissioned only if the collector has a minimum temperature of 30 °C and the required temperature differential is reached.

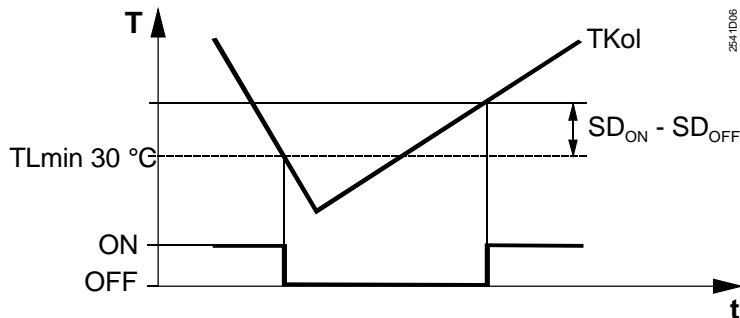

TKol Collector temperature
 ON/OFF Collector pump
 SD_{ON} Temperature differential ON
 SD_{OFF} Temperature differential OFF
 TLmin Minimum charging temperature
 T Temperature
 t Time

- Charging is stopped (even if the switch-on differential is reached) if the collector temperature is below the charging temperature:
 $TKol < TLmin$
- Charging takes place if the collector temperature exceeds the minimum charging temperature (and if the required switch-on differential is reached) by the switch-on differential ($SD_{ON} - SD_{OFF}$):
 $TKol > TLmin + (SD_{ON} - SD_{OFF})$

33.2.3 Minimum runtime

When the collector pump is switched on, it remains on for min. runtime $t_{Min} = 20$ s. This minimum runtime is enabled for all functions activating the collector pump.

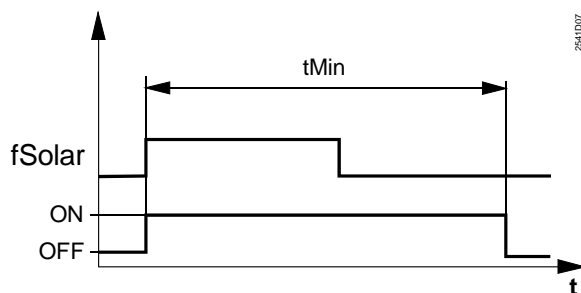

fSolar Solar function
ON/OFF Collector pump
tMin Minimum runtime

Special case: Frost protection

Collector pump switch-off is delayed by the minimum runtime after the frost protection limit is reached to rinse the flow pipe between collector to storage tank with hot water.

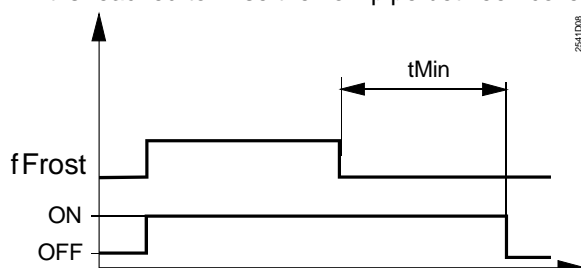

fFROST Frost protection function solar
ON/OFF Collector pump
tMin Minimum runtime

33.2.4 Collector frost protection temperature

Operating line 203 is used to set the frost protection temperature for the collector. The collector pump is operated if there is a risk of frost at the collector to prevent the heat carrier from freezing.

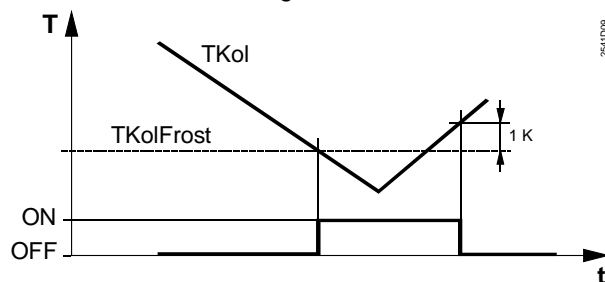

TKol Collector temperature
TKoIFrost Collector frost protection temperature
ON/OFF Collector pump
T Temperature
t Time

- The collector pump switches on if the collector temperature drops below the frost protection temperature: $TKol < TKoIFrost$
- The collector pump is switched off if the collector pump rises above the frost protection temperature by 1 K: $TKol > TKoIFrost + 1K$.
- The frost protection function is stopped if d.h.w. storage tank temperature drops below 8 °C.

Setting --- switches off the collector frost protection function.

33.2.5 Collector temperature to protect against overheating

Operating line 204 allows for setting the temperature protecting the collector against overheating.

If there is a risk of overheating at the collector, storage tank charging is continued past the charging temperature maximum limitation (set on operating line 206) to the storage tank temperature maximum (set on operating line 207) to reduce the amount of surplus heat.

Collector overheating protection is no longer possible and the collector pump is switched off after the storage tank temperature maximum limitation is reached.

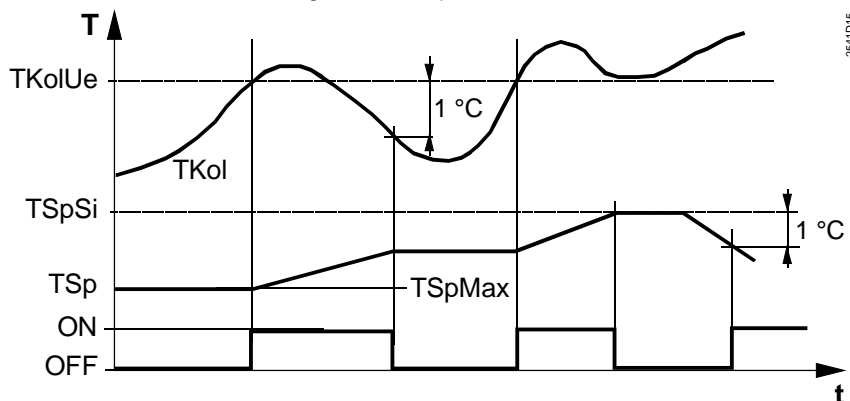

TSpSi	Storage tank temperature maximum limitation
TSp	Storage tank temperature
TKolUe	Collector overheating protection temperature
TSpMax	Charging temperature maximum limitation
TKol	Collector temperature
ON/OFF	Collector pump
T	Temperature
t	Time

- The collector pump is switched on if the collector temperature exceeds the collector temperature overheating protection temperature and if the storage tank temperature maximum limitation is not yet reached: $TKol > TKolUe$ and $TSp < TSpSi$.
The collector pump is switched off if the collector temperature drops by 5 K below the overheating protection temperature: $TKol < TKolUe - 5 K$
- The collector pump is switched off if the current storage tank temperature reaches the maximum limitation:
 $TSp > TSpSi$
The collector pump is again switched on if the storage tank temperature drops by 1 K below the d.h.w. storage tank temperature maximum limitation:
 $TSp < TSpSi - 1 K$

In the case of two storage tank sensors, the hotter of the two is the decisive sensor.
Setting --- switches off collector overheating protection.

33.2.6 Storage tank recooling

Function "Storage tank recooling" cools down d.h.w. storage tank – after collector overheating protection – to a lower temperature level.

Storage tank recooling is carried out via collector surface. In this case, the energy of the d.h.w. storage tank is emitted in the environment via the collector surface by switching on the collector pump.

The recooling setpoint (TRk) is set to a fixed 80 °C.

The switching differential for recooling (SDON) corresponds to the value of the switch-on differential (operating line 201) of charge control, but is limited to min. 3 K for recooling.

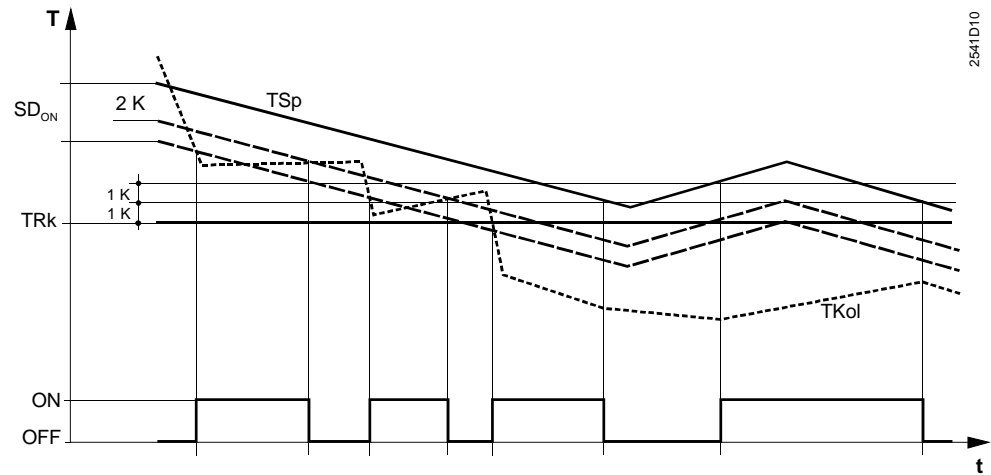

SD _{ON}	Temperature differential ON
TRk	Recooling setpoint
TSp	Storage tank temperature
TKol	Collector temperature
ON/OFF	Collector pump
T	Temperature
t	Time

- The collector pump is switched on if the storage tank temperature is at least 2 K above the recooling setpoint and above the collector temperature by temperature differential ON.
 $T_{Sp} > TRk + 2\text{ K}$ and $T_{Sp} > TKol + SD_{ON}$
- The collector pump is switched off if the collector temperature rises to 2 K of the storage tank temperature.
 $TKol > T_{Sp} - 2\text{ K}$
- The function is stopped if the storage tank temperature reaches the recooling setpoint to 1 K.
 $T_{Sp} < TRk + 1\text{ K}$

33.2.7 Evaporation temperature of heat carrier

Operating line 205 allows for setting the evaporation temperature of the heat carrier. If there is a risk of evaporation at the heat carrier (due to the high collector temperature), the collector pump is switched off to prevent it from running hot. This is a pump protection function.

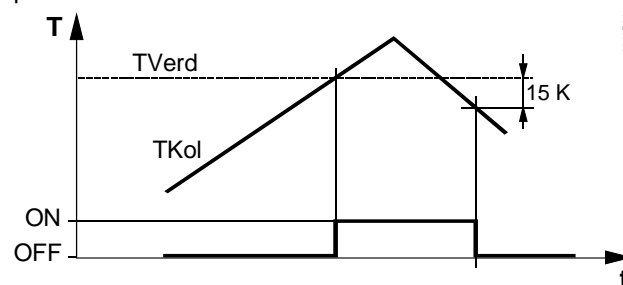

TVerd	Evaporation temperature of heat carrier
TKol	Collector temperature
ON/OFF	Collector pump
T	Temperature
t	Time

- The collector pump is switched off if the collector temperature exceeds the evaporation temperature:
 $TKol > TVerd$
- The collector pump is again switched on if the collector temperature drops below the evaporation temperature by 15 K:
 $TKol < TVerd - 15 K$

Setting --- switches off the pump protection function.

The heat carrier evaporation protection (pump off) takes priority over overheating protection which would switch on the pump.

33.2.8 Maximum limitation of charging temperature

Operating line 206 allows for setting the maximum limitation for charging temperature. The collector pump is switched off if the maximum charging temperature in the storage tank is reached.

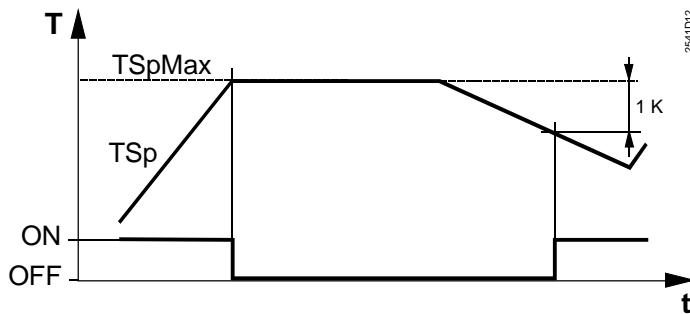

TSp	Storage tank temperature
TSpMax	Maximum limitation of the charging temperature-
ON/OFF	Collector pump
T	Temperature
t	Time

- Charging is stopped if the storage tank temperature exceeds the maximum limitation:
 $TSp > TSpMax$
- Charging is again released if the storage tank temperature drops below the maximum limitation by 1 K:
 $TSp < TSpMax - 1 K$

Note

The collector overheating protection function can again activate the collector pump until the storage tank temperature maximum limitation is reached.

33.2.9 Storage tank temperature maximum limitation

Operating line 207 allows for setting the d.h.w. storage tank temperature maximum limitation.

The storage tank is never charged in excess of the set temperature (refer to section "33.2.5").

Caution

The storage tank maximum limitation function is not a safety function!

33.2.10 Collector start function gradient

The pump must periodically be switched on, as the temperature at the collector (primarily vacuum pipes) cannot be measured reliably when the pump is off.

Operating line 208 allows for setting the collector start gradient function.

The pump is switched on if the collector temperature increases by less than the set gradient. The pump remains on if the required temperature increase at the collector is reached within one minute.

The pump is again switched off if the collector temperature does not reach the required level or continues to drop.

The gradient corresponds to the time period required to increase the collector's stationary temperature by 1 °C.

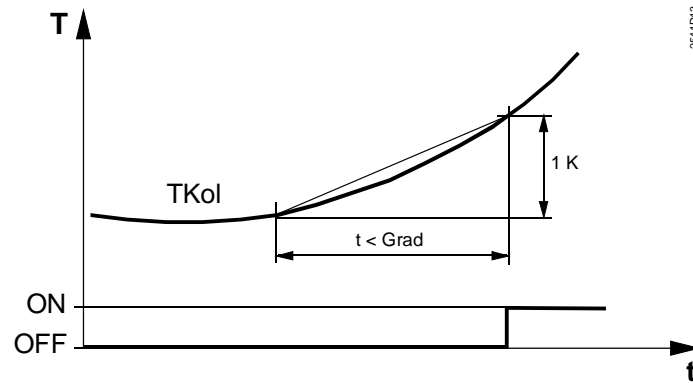

2541D13

TKol	Collector temperature
Grad	Gradient
ON/OFF	Collector pump
T	Temperature
t	Time

Setting --- switches off the collector start function.

34 Function block "Locking functions"

Function block "Locking functions" allows all settings to be locked on the software side.

34.1 Operating line







<i>Line</i>	<i>Function, parameter</i>	<i>Factory setting (range)</i>	<i>Unit</i>
248	Locking of settings	0 (0 / 1)	

34.2 Description

On operating line 248, the settings made on the controller can be locked on the software side. This means that the settings made can still be called up on the controller, but cannot be changed. Locking comprises all settings.

The settings can be changed via the bus.

The procedure is the following:

1. Press buttons  and  together until **[od]** appears on the display.
2. Press buttons , ,  and , one after the other.
3. Now, operating line 248 appears on the display. The numbers on the display have the following meaning:
0 = No locking; all settings can be readjusted
1 = All settings are locked

After locking all settings, the following setting elements remain operative:

- The buttons for selecting the operating lines
- The info button

No longer operative will be:

- The buttons for the readjustment of values
- The little bar for changing the basic setting of the heating curve
- The knob for readjusting of the room temperature
- The operating mode buttons
- The manual mode button

35 Communication

35.1 Combination with room units

35.1.1 General

- Room units can be used with the RVL482 only if one of the plant types 1-x, 2-x, or 3-x has been selected on the controller
- The room temperature acquired by a room unit is adopted by the RVL482 at terminal A6. If the room temperature signal delivered by the room unit shall not be considered by the control functions, the respective source needs to be selected (operating line 65). The other room unit functions will then be maintained
- The connection of an inadmissible room unit is detected by the RVL482 as a fault and displayed as such on operating line 50 (error code 62)
- Faults that the room unit detects in itself are displayed by the RVL482 on operating line 50 (error code 61)
- The identification number of the room unit can be queried on operating line 196

35.1.2 Combination with room unit QAW50



Room unit QAW50 with room temperature sensor and room temperature readjustment (setting knob)

The QAW50 can act on the RVL482 as follows:

- Overriding the operating mode of the heating circuit
- Readjustment of room temperature

For this purpose, the QAW50 has 3 operating elements:

- Operating mode slider
- Economy button (also called presence button)
- Knob for room temperature readjustments







Overriding the heating circuit's operating mode

From the QAW50, the operating mode of the RVL482 can be overridden. This is accomplished with the operating mode slider and the economy button.

To enable the room unit to act on the RVL482, the following operating conditions must be satisfied on the controller:

- AUTO mode for heating circuit
- No holiday period active, no manual operation

The impact of the QAW50's operating mode slider on the RVL482 is as follows:

Operating mode QAW50	Heating circuit's operating mode RVL482
	Auto  ; temporary overriding with QAW50 economy button possible
	Continuously NORMAL  or continuously REDUCED  heating, depending on the economy button, permanent overriding
	Protection 

Knob for room temperature readjustments

Using the knob of the QAW50, the room temperature setpoint of NORMAL heating can be readjusted by ± 3 °C.

The adjustment of the room temperature setpoint on the controller's operating line 1 will not be affected by the QAW50.

35.1.3 Combination with room unit QAW70



Room unit QAW70 with room temperature sensor, time switch, setpoint adjustment and room temperature readjustment (setting knob)

Using the QAW70, the following functions can be performed or the room unit can act on the RVL482 as follows:

- Overriding the heating circuit's operating mode
- Readjustment of room temperature setpoints
- Readjustment of the d.h.w temperature setpoint
- Readjustment of the room temperature
- Entry of time of day
- Overriding the heating program
- Display of the actual values acquired by the RVL482

For this purpose, the QAW70 has the following operating elements:







- Operating mode buttons
- Economy button (also called presence button)
- Knob for room temperature readjustments
- Buttons for selecting the operating lines
- Buttons for changing the values

Overriding the heating circuit's operating mode

From the QAW70, the heating circuit's operating mode of the RVL482 can be overridden. This is accomplished with the operating mode button and the economy button. To enable the room unit to act on the RVL482, the following operating conditions must be satisfied on the controller:

- AUTO mode for heating circuit
- No holiday period active, no manual operation

The impact of the QAW70's operating mode buttons on the RVL482 is as follows:

<i>Operating mode QAW70</i>	<i>Heating circuit's operating mode RVL4821</i>
	Auto  ; temporary overriding with economy button possible
	Continuously NORMAL  or continuously REDUCED  heating, depending on the economy button, permanent overriding
	Protection 

Knob for room temperature readjustments

With the knob of the QAW70, the room temperature setpoint of NORMAL heating can be readjusted by ± 3 °C.

The adjustment of the room temperature setpoint on the controller's operating line 1 will not be affected by the QAW70.

Effect of individual QAW70 operating lines on the RVL482

If 1 (slave with no remote operation) is entered on operating line 178 (source of time of day) of the RVL482, the time of day on the QAW70 cannot be changed.

<i>Line QAW70</i>	<i>Function, parameter</i>	<i>Impact on the RVL482, notes</i>
1	Setpoint of NORMAL heating	Changes operating line 1 on the RVL482
2	Setpoint of REDUCED heating	Changes operating line 2 on the RVL482
3	D.h.w temperature setpoint	Changes operating line 26 on the RVL482 with plant types that include d.h.w. heating
4	Weekday (entry of heating program)	Corresponds to operating line 4 on the RVL482
5	1. Third heating period, start of NORMAL heating	Changes operating line 5 on the RVL482
6	1. Third heating period, start of REDUCED heating	Changes operating line 6 on the RVL482
7	2. Third heating period, start of NORMAL heating	Changes operating line 7 on the RVL482
8	2. Third heating period, start of REDUCED heating	Changes operating line 8 on the RVL482
9	3. Third heating period, start of NORMAL heating	Changes operating line 9 on the RVL482
10	3. Third heating period, start of REDUCED heating	Changes operating line 10 on the RVL482
11	Display of weekdays 1...7	Cannot be adjusted (refer to subsection "7.3 Time of day and date")
12	Entry of time of day	Changes operating line 38 on the RVL482
13	Display of the d.h.w. temperature	Only with plant types that include d.h.w. heating (corresponds to line 27)
14	Display of the boiler temperature acquired with sensor B2	Only with plant types that include boiler control (only with plant types 1-x) ---
15	Display of the flow temperature acquired with sensor B1	Only with plant types with mixing valve. Display with plant types 4-x and 5-x: ---
16	Holidays	RVL482 changes to protection mode
17	Reset to default values	QAW70 default values are used
51	Bus address	With the RVL482, the bus address to be entered on the room unit is 1
52	Identification of room unit	Display on operating line 196 of the RVL482
53	Operating lock on QAW70	No impact on the RVL482
58	Type of setpoint display	No impact on the RVL482

Note

For detailed information about the QAW70 room unit, refer to installation instructions G1637 (74 319 0173 0).

Overriding the QAW70 entries from the RVL482

If the RVL482 with a connected QAW70 is isolated from the mains network and then reconnected, the following parameters on the QAW70 will be overwritten with the settings made on the RVL482:

- Time of day and weekday
- Complete heating program
- Room temperature setpoint of REDUCED heating
- Room temperature setpoint of REDUCED heating
- Normal setpoint of the d.h.w. temperature

This means that the RVL482 is always the data master.

35.2 Combination with SYNERGYR central unit OZW30

Based on the room temperature of the individual apartments, the OZW30 central unit (software version 3.0 or higher) generates a load compensation signal. This signal is passed on via the LPB to the RVL482 where it produces an appropriate change of the flow temperature setpoint.

35.3 Communication with other devices

The RVL482 offers the following communication choices:

- Delivery of the heat demand signal to the heat source
- Exchange of locking and forced signals
- Exchange of measured values such as outside temperature, return temperature and flow temperature, as well as clock signals
- Controller RVL481 is not compatible with the RVL469; RVL479 is downward compatible
- Exchange of error messages

For detailed information about the communication via LPB, refer to the following pieces of documentation:

- Data sheet N2030, Basic System Data
- Data sheet N2032, Basic Engineering Data

36 Handling

36.1 Operation

36.1.1 General

Operating elements

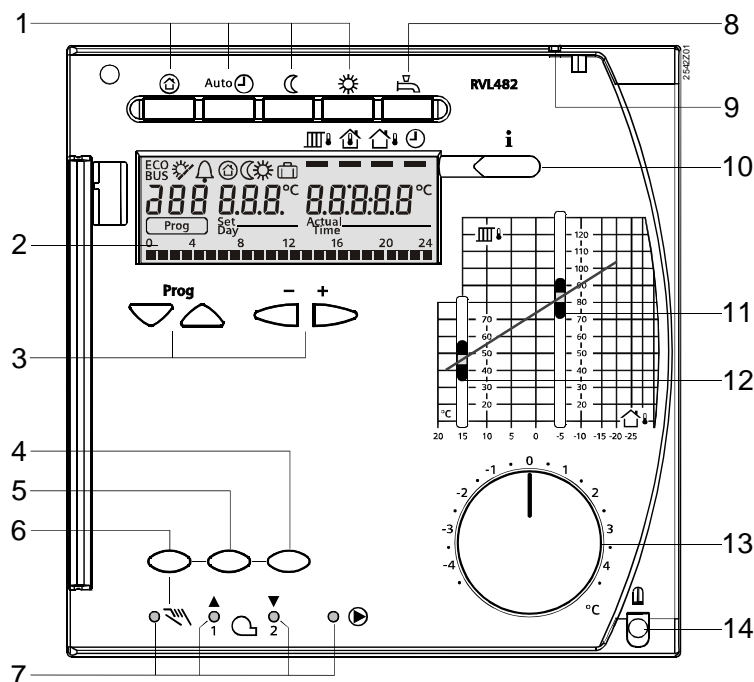

- 1 Operating mode buttons (selected button is lit)
- 2 Display (LCD)
- 3 Buttons for operating the display:
Prog = selection of operating line
- + = adjustment of displayed value
- 4 Button for "Close heating circuit mixing valve" or reduce modulation, or burner stage 2 ON/OFF in manual operation
- 5 Button for "Open heating circuit mixing valve" or increase modulation in manual operation
- 6 Button for manual operation
- 7 LEDs for:
 - ☰ Manual operation
 - ☐ / ▲ Heating circuit mixing valve opens / burner modulation actuator opens / burner stage 1 ON
 - ☐ / ▼ Heating circuit mixing valve closes / burner modulation actuator closes / burner stage 2 ON
 - Pump runs
- 8 Button for d.h.w. heating ON/OFF (ON = button lit)
- 9 Sealing facility in the cover
- 10 Info button for the display of actual values
- 11 Setting slider for flow temperature setpoint at an outside temperature of -5 °C
- 12 Setting slider for flow temperature setpoint at an outside temperature of 15 °C
- 13 Setting knob for readjustment of room temperature
- 14 Fixing screw with sealing facility

Display

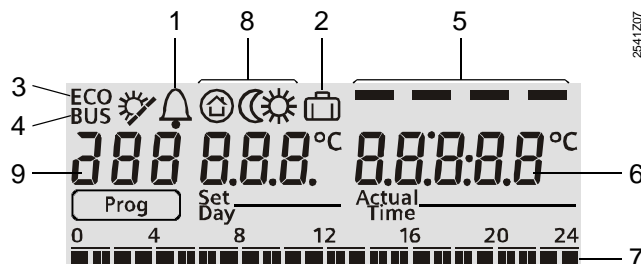

- 1 Display of fault status messages
- 2 Display of "Holiday program active"
- 3 Display of "ECO function active"
- 4 Display of "Bus power supply available"
- 5 Cursor for Info button (display of temperatures)
- 6 Display of temperatures, times, etc.
- 7 Display of the current heating program
- 8 Display of operational level
- 9 Display of the current operating line number

Operating instructions

The operating instructions are inserted in a holder at the rear of the cover. When in their proper place, the list of operating lines that can be selected by the enduser is visible.

The operating instructions are designed for use by janitors and endusers. They also contain tips on energy savings and troubleshooting.

36.1.2 Analog operating elements

Buttons for selecting the heating circuit's operating mode

For the selection of the operating mode, there are 4 buttons available. The required operating mode is activated by pressing the respective button. Each button has an LED integrated; the currently active operating mode is indicated by the respective LED.

D.h.w. button

A button is used to switch d.h.w. heating on and off. By pressing the respective button, d.h.w. heating is switched on or off. The button is lit when d.h.w. heating is switched on. Manual d.h.w. charging is also triggered by pressing the same button.

Heating curve

For the direct setting of the heating curve, the little bar is used, which has proven its worth over many years. The slider on the left is used to set the required flow temperature at an outside temperature of +15 °C, the slider on the right to set it at -5 °C.

The link between the 2 sliders represents the heating curve.

The heating curve can also be entered via the operating lines. In that case, the position of the little bar is of no importance.

Knob for room temperature readjustments

A knob is used for manual room temperature readjustments. Its scale gives the room temperature change in °C.

By turning the knob, the heating curve is displaced parallel (functionally), but the bar maintains its position.

Buttons and displays for manual operation

3 buttons are used for manual operation:

- One button for activating manual operation. An LED indicates manual operation. Manual operation is quit by pressing the same button again or by pressing any at the operating mode buttons
- 2 buttons for manual positioning commands.
 - In plants using mixing valves, the actuating device can be driven to any position by pressing the respective button .
 - In plants with direct burner control:
 - In the case of a 2-stage burner, burner stage 2 can be switched on and off by pressing the ▼ button
 - In the case of a modulating burner, the burner's damper actuator can be driven to any position by pressing the respective button

When pressing a button, the associated LED is lit.

Display of positioning commands

The LEDs by the ▲ and ▼ symbols indicate the positioning commands:

☒ / ▲ = Heating circuit mixing valve OPENS, or damper actuator of the modulating burner OPENS, or burner stage 1 ON

☒ / ▼ = Heating circuit mixing valve CLOSES, or damper actuator of the modulating burner CLOSES, or burner stage 2 ON

Display "Heating operates"

The LED by the pump symbol  is lit when the heating circuit pump M2 (plant types 1-x, 2-x, 3-x) or the circulating pump/bypass pump M1 (plant types 4-x, 5-x) is running.

36.1.3 Digital operating elements





Operating line principle

The entry and readjustment of all setting parameters, the activation of optional functions and the reading of actual values and states are based on the operating line principle. An operating line with an associated number is assigned to each parameter, each actual value and each optional function.

The selection of an operating line and readjustment of the display is always made with a pair of buttons.



Buttons

To select and readjust setting values, the procedure is the following:

<i>Buttons</i>	<i>Procedure</i>	<i>Impact</i>
Line selection buttons	Press button 	Selection of the next lower operating line
	Press button 	Selection of the next higher operating line
Setting buttons	Press button 	Decrease of the displayed value
	Press button 	Increase of the displayed value





The value set will be adopted:

- When selecting the next operating line
- By pressing the Info button
- By pressing any of the operating mode buttons

If entry of --.- or --:-- is required, button  or  must be pressed until the required display appears. Then, the display maintains --.- or --:--.





Block skip function

The operating lines are grouped as blocks. To reach a specific operating line of a block quickly, the other blocks can be skipped, so that it will not be necessary to select all the other lines one by one. This is accomplished by using 2 combinations of buttons:

<i>Procedure</i>	<i>Effect</i>
Keep  depressed and press 	Selection of the next higher function block
Keep  depressed and press 	Selection of the next lower function block

Info button

The Info button is used to obtain basic information about the plant. Pressing this button, the cursor  in the display is placed below the required symbol. The numbers on the display have the following meaning:











<i>Symbol</i>	<i>Display of</i>
	Flow or boiler temperature
	Room temperature
	Outside temperature
	Time of day

It is always the information selected last that is continuously displayed.

36.1.4 Setting levels and access rights

Setting levels

The operating lines are assigned to 3 different levels. Assignment and access are as follows:

<i>Level</i>	<i>Operating lines</i>	<i>Access</i>
End-user	1...50	Press  or  together
Heating engineer	51...197	Press  and  for 3 seconds
Locking level	248	 Press  and together until  appears; then, press  ,  ,  and  one after the other

Access rights

- The enduser can access all analog operating elements. This means that he can select the operating mode, set the heating curve, readjust the room temperature with the setting knob, and activate manual operation.
Also, he can access operating lines 1 to 50
- The heating engineer can access all operating elements and all operating lines



36.2 Commissioning

36.2.1 Installation instructions

The RVL482 is supplied complete with Installation Instructions, which give a detailed description of installation, wiring and commissioning with functional checks and settings. They have been written for trained specialists. Each operating line has an empty field in which the selected value can be entered.

The Installation Instructions should not be thrown away after use but kept together with the plant documentation.

36.2.2 Operating lines

Selecting operating line "Plant type"

The most important work to be performed when commissioning the plant is entering the required type of plant. This entry activates all functions and settings required for the respective plant type.

Setting the other operating lines

All operating lines contain proven and practice-oriented values. Coding, guide values, explanations, etc., are given in the Installation Instructions where required.

Operating lines for functional checks

Function block "Service functions" and general settings contains 4 operating lines that are especially suited for making functional checks:

- Operating line 161 permits simulation of the outside temperature
- On operating line 162, each of the output relays can be energized
- On operating line 163, all actual sensor values can be called up
- On operating line 164, the states of the H-x contacts can be called up

If the display shows , the fault can be pinpointed via the error code on operating line 50.

36.3 Installation

36.3.1 Mounting location

The ideal location for the controller is a dry room, such as the boiler room. Its degree of protection is IP42 to EN 60529, which means that the controller is protected against dripping water.

The permissible ambient temperature is 0...50 °C.

The RVL482 can be fitted as follows:

- In a control panel (on the inner wall or on a top hat rail)
- On a panel front
- In the control panel front
- In the sloping front of a control desk

36.3.2 Mounting choices

The RVL482 can be mounted in one of 3 different ways:

- Wall mounting: The base is secured to a flat wall with 3 screws
- Rail mounting: The base is snapped on a top hat rail
- Flush panel mounting: The base is fitted in a panel cutout measuring 138 x 138 mm (+1 mm / -0 mm). The thickness of the front panel may be 3 mm maximum

36.3.3 Electrical installation



- Local regulations for electrical installations must be complied with
- Only qualified staff may carry out electrical installations
- The cable lengths should be chosen such that there is sufficient space to open the control panel door
- Cable tension relief must be ensured
- The cables of the measuring circuits carry extra low-voltage
- The cables from the controller to the actuating device and the pump carry mains voltage
- The cables to the sensors must not be run parallel to mains carrying cable (e.g. power supply for the pump) (protection class II EN 60730)

37 Engineering

37.1 Connection terminals

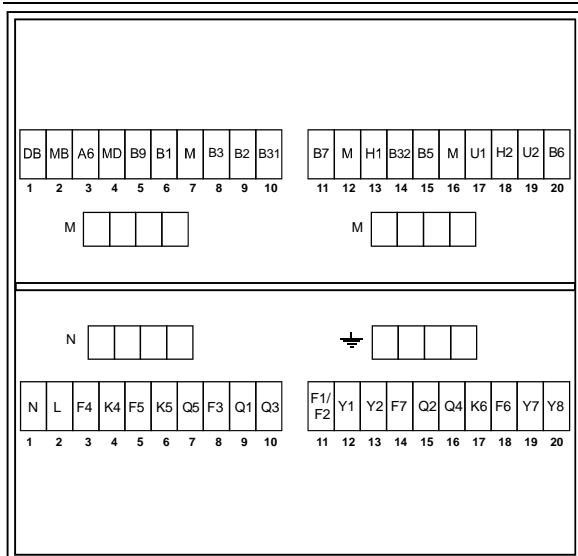

37.1.1 Low-voltage side

DB	Data LPB
MB	Ground for LPB
A6	PPS (point-to-point interface), connection of room unit
MD	Ground for PPS
B9	Outside sensor
B1	Flow sensor
M	Ground for sensors, changeover contacts and signal inputs (4 times)
B3	D.h.w. flow sensor
B2	Boiler sensor
B31	Storage tank sensor / thermostat 1
B7	Return sensor
H1	Changeover contact "Operating mode"
B32	Storage tank sensor / thermostat 2
B5	Room sensor
U1	Solar sensor or heat demand signal DC 0...10 V
H2	Changeover contact "flow temperature setpoint"
U2	Wind sensor or heat demand signal DC 0...10 V
B6	Collector sensor

In addition to the standard connection terminals, there are 2 auxiliary terminals M available.

37.1.2 Mains voltage side

N	Neutral AC 230 V
L	Live AC 230 V
F4	Input for K4
K4	1. Burner stage ON
F5	Input for K5
K5	2. Burner stage ON / damper actuator of modulating burner OPENS
Q5	Collector pump
F3	Input for Q5, Q1, and Q3
Q1	Circulating pump / bypass pump ON
Q3	Charging pump ON
F1/F2	Input for Y1 and Y2
Y1	Heating circuit mixing valve OPENS
Y2	Heating circuit mixing valve CLOSES
F7	Input for Q2, Q4 and K6
Q2	Heating circuit pump ON
Q4	Boiler pump / circulating pump ON
K6	Multifunctional relay energized / damper actuator of modulating burner CLOSES
F6	Input for Y7 and Y8
Y7	D.h.w circuit mixing valve or mixing valve for the boiler return limitation OPENS
Y8	D.h.w circuit mixing valve or mixing valve for the boiler return limitation CLOSES

In addition to the standard connection terminals, there are 2 auxiliary terminals for N and --- available.

37.2 Connection diagrams

Low-voltage side

Basic connections for plant types with external heat demand signals

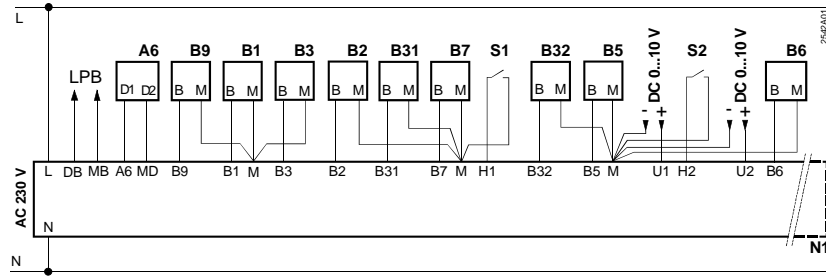

Basic connections for plant types with solar sensor and wind sensor

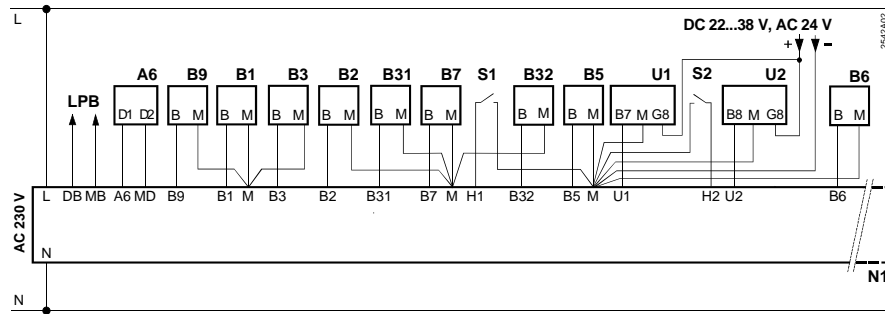

Mains voltage side

Basic connections for plant types using a 2-stage burner

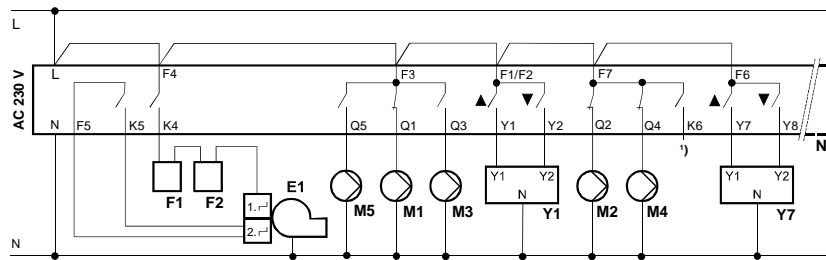

Basic connections for plant types using a modulating burner

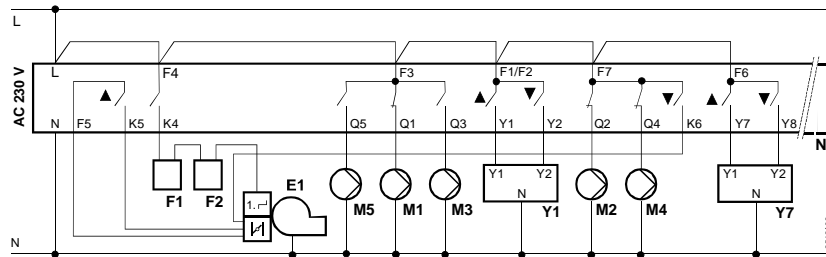

- | | | | |
|-----|--------------------------------------|----|---|
| A6 | Room unit | M1 | Circulating pump / bypass pump |
| B1 | Flow sensor | M2 | Heating circuit pump |
| B2 | Boiler sensor | M3 | Charging pump |
| B3 | D.h.w. flow sensor | M4 | Boiler pump / circulating pump |
| B31 | Storage tank sensor / thermostat 1 | M5 | Collector pump |
| B32 | Storage tank sensor / thermostat 2 | N1 | Controller RVL482 |
| B5 | Room sensor | S1 | Remote operation "Operating mode" |
| B6 | Collector sensor | S2 | Remote operation "Flow temperature setpoint" |
| B7 | Return sensor | U1 | Solar sensor |
| B9 | Outside sensor | U2 | Wind sensor |
| E1 | 2-stage or modulating burner | Y1 | Actuator heating circuit |
| F1 | Thermal reset limit thermostat | Y7 | Actuator d.h.w. circuit / actuator boiler return mixing valve |
| F2 | Manual reset safety limit thermostat | | |
| LPB | Data bus | 1) | Multifunctional output |

38 Mechanical design

38.1 Basic design

The controller consists of a controller insert, which accommodates the electronics, the power section, the output relays and – on the front – all operating elements, and the base, which carries the connection terminals. The operating elements are located behind a lockable transparent cover. On the inner side of the cover, there is a holder in which the Operating Instructions can be inserted.

All values are read in the display (LCD) featuring background lighting.

The transparent cover is lockable and can be sealed.

The RVL482 has standard overall dimensions 144 x 144 mm.

It can be mounted in one of 3 different ways:

- Wall mounting
- Rail mounting
- Flush-panel mounting

Whichever mounting method is chosen, the base must always be mounted and wired first. To ensure orientation will be correct, the upper side of both the base and the controller housing carry the marking TOP. Both the top and the bottom side of the base have 5 knockout holes for cable entries, and there are 10 knockout holes in the floor. The controller insert is placed in the base. The controller insert has 2 fixing screws with rotating levers. If, after insertion of the controller insert, one of the screws is tightened, the lever engages in an opening in the base. When the screws are further tightened (alternately), the controller pulls itself into the base so that it is secured.

The fixing screw at the bottom can be sealed: insert the grommet (attached to the key ring) in the screw hole, introduce a safety wire through the 2 lugs and seal.

38.2 Dimensions

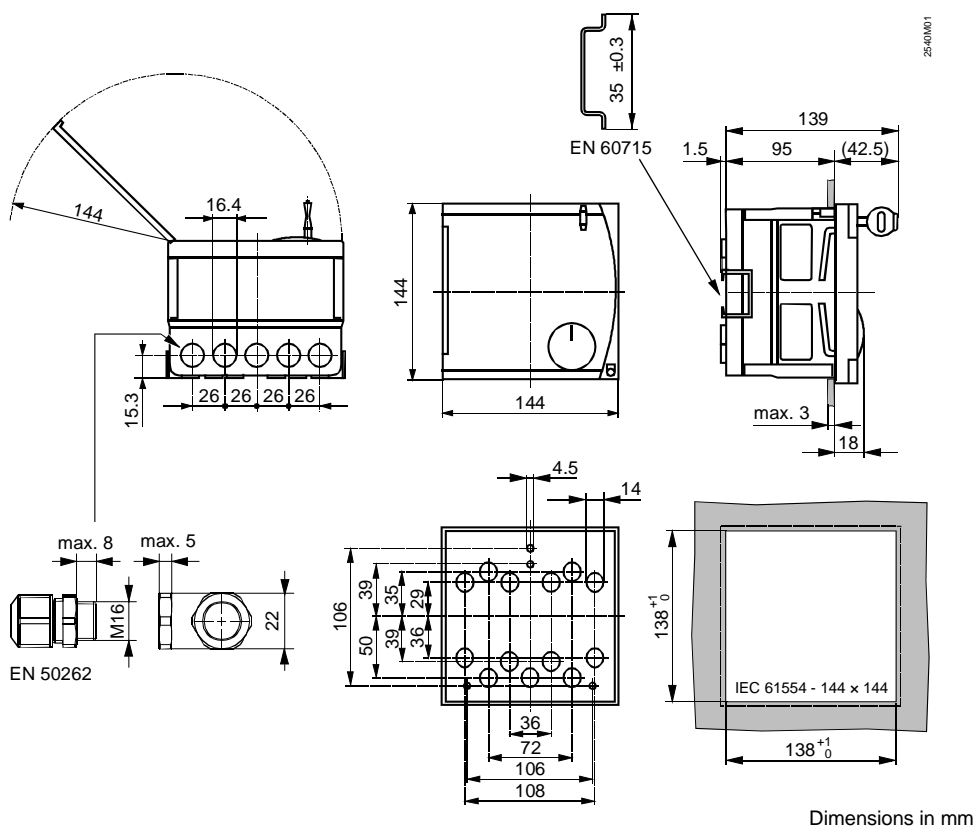

39 Technical data

Power supply	Rated operating voltage	AC 230 V (±10 %)		
	Frequency	50 Hz		
	Power consumption (no external load)	max. 9 VA		
	Supply line fusing	10 A		
Output relays	Switching capacity	AC 24...230 V		
	Switching current K4, K5, Q1, Y1, Y2, Y7, Y8	AC 0.02...2 (2) A		
	Switching current Q5, Q3, Q2 Q4, K6	AC 0.02...1 (1) A		
	Rated current of ignition transformer	max.1 A (max. 30 s)		
	Switch-on current of ignition transformer	max.10 A (max. 10 ms)		
Permissible cable lengths to sensors and room unit	Copper cable 0.6 mm Ø	20 m		
	Copper cable 0.5 mm ²	50 m		
	Copper cable 1.0 mm ²	80 m		
	Copper cable 1.5 mm ²	120 m		
Connection terminals	Screw terminals for wire section	up to 2.5 mm ²		
Communication by wire	Bus protocol/type	LPB		
	Bus loading characteristic E	9		
Backup	Backup of controller clock	12 h		
Standards	CE-conformance to EMC directive	2004/108/EC		
	– Immunity	– EN 61000-6-1 / -2		
	– Emissions	– EN 61000-6-3 / -4		
	Low voltage directive	2006/95/EC		
	– Safety	– EN 60730-1 / EN 60730-2-9		
Protective data	Safety class	II to EN 60730		
	Degree of protection (cover closed)	IP42 to EN 60529		
	Degree of contamination	2 to EN 60730		
Dimensions		refer to "Dimensions"		
Weight	Unit (net)	1.2 kg		
Colors	Controller insert	Light grey RAL 7035		
	Terminal base	Pigeon blue RAL 5014		
Environmental conditions		<i>Operation</i>	<i>Transport</i>	<i>Storage</i>
		EN 60721-3-3	EN 60721-3-2	EN 60721-3-1
	Climatic conditions	class 3K5	class 2K3	class 1K3
	Temperature	0...+50 °C	–25...+70 °C	–20...+65 °C
	Humidity	<95 % r.h. (non-condensing)	<95 % r.h.	<95 % r.h. (non-condensing)
	Mechanical conditions	class 3M2	class 2M2	class 1M2
	Use above sea level	max. 3000 m above sea level		

Index

2	
2-position control.....	55
3	
3-position actuator d.h.w.....	81
3-position actuator maximum limitation of the return temperature.....	67
3-position control.....	52
A	
absolute priority.....	74
access rights.....	116
acknowledgment.....	36
acquisition of measured values.....	27
acquisition of the d.h.w. storage tank temperature ...	77
actual outside temperature	41
addressing the devices	96
analog operating elements.....	115
assignment of d.h.w. heating	69
attenuated outside temperature	41
automatic operation	24
auxiliary terminals	119
B	
backup of time switch.....	122
bar.....	48
base	121
basic heating curve setting	48
bivalent maximum limitation of the return temperature	66
bivalent starting point	61
block skip function.....	116
boiler operating mode	53
boiler temperature.....	28
boost heating	46
boost of the d.h.w. charging temperature	78
building time constant	41
burner cycling protection.....	54
burner running time.....	54
bus loading number	97
bus power supply	97
buttons for selecting the heating circuit's operating mode	115
bypass pump.....	60, 62, 64
C	
cascade slave	40
CE conformity	122
central unit OZW30	113
charging temperature max. limitation solar	107
charging with hot water and electricity	76
circulating pump	70
collector frost protection	104
collector pump.....	104
collector start function	107
collector stationary temperature.....	107
collector temperature	31
collector temperature	103
combination with room units.....	110
commissioning	117
commissioning aids.....	89
communication	14, 113
compensating variables	13
compensating variables and auxiliary variables.....	41
connection diagrams	120
connection terminals	119
contact H1	93
contact H2.....	98
contacts H	91
continuously NORMAL.....	24
continuously REDUCED	24
control with a 2-stage burner.....	55
control with a single-stage burner	54
controller insert.....	121
critical locking signal	62
critical locking signals.....	94
D	
d.h.w temperature control	81
d.h.w. button	115
d.h.w. charging.....	76
d.h.w. flow temperature	29
d.h.w. heating.....	24
d.h.w. operating modes.....	24
d.h.w. plant types	21
deflection of heating curve	49
derivative action time	82
development of outside temperature.....	41
digital operating elements	116
dimensions	121
direct burner control	53
display	114
display functions.....	88
display setpoints (heating curve).....	50
documentation.....	14

E			
ECO function	41	function block modulating burner.....	39
ECO heating limits.....	42	function block multifunctional relay.....	83
economy button.....	111	function block plant type	37
economy button.....	110	function block pump M1.....	60
electric immersion heater	83	function block release, priority and flow temperature setpoint of d.h.w.	72
electronics	121	function block service functions and general settings	88
end point bivalent	66	function block setpoint of return temperature limitation	61
engineering.....	119	function block switching program 3	87
entries for LPB.....	95	function block three-position actuator heating circuit	51
error messages	36	function block type of heat source	38
evaporation temperature of heat carrier	106	function block type of limitation of return temperature	62
excess mixing valve temperature	52	function blocks.....	17, 23
		functions	15
F		G	
features	13	gain factor of room influence	47
field of use	15	gain of locking signal	94
flow alarm	92	generation of setpoint	50
flow temperature.....	27	gradient collector start function.....	107
flow temperature setpoint, display.....	88	H	
flush-panel mounting	117	handling faults	27, 28
forced charging.....	79	heat demand.....	14, 84
forced signal	59	heat demand inputs	97
frost protection for d.h.w.	71	heat demand signal	100
frost protection for the boiler.....	57	heat exchanger.....	82
frost protection for the building	32	heat source cascade	40
frost protection for the plant.....	92	heat storage capacity	41
Frost protection function solar	104	heating circuit operating modes.....	24
function block	102	heating circuit plant types	19
function block "space heating"	41	heating curve	48, 51, 115
function block 3-position actuator for d.h.w.	81	heating curve, display	89
function block 3-position actuator maximum limitation of the return temperature.....	67	heating limits.....	42
function block assignment of d.h.w. heating.....	69	heating program	32
function block bivalent maximum limitation of the return temperature.....	66	heating up brake	51
function block boiler.....	53	holiday mode	24, 33
function block cascade slave.....	40	holiday period	33
function block circulating pump	70	holiday program.....	33
function block contact H2	98	hot run of collector pump	106
function block d.h.w. storage tank	76	hours run counter	101
function block derivative action time d.h.w. heating via heat exchanger.....	82		
function block enduser d.h.w.	34	I	
function block enduser general	35	identification number	110
function block enduser space heating	32	identification of room unit.....	101
function block external inputs	99	inadmissible room units	101
function block integral action time maximum limitation of the return temperature.....	68	indication of errors	36
function block legionella function.....	85	info button	116
function block locking functions.....	109	installation.....	117

installation instructions.....	117
integral action time maximum limitation of the return temperature.....	68
K	
key features	13, 17
knob	115
L	
legionella function	79, 85
line selection buttons	116
locked on the software side	109
locking functions	109
locking settings	109
LPB	95
M	
manual d.h.w. charging.....	80
manual operation	25
manual operation buttons	25, 115
manual positioning commands	115
manually ON / OFF	84
master clock.....	95
max. limitation charging temperature solar	107
maximum charging time.....	78
maximum limitation acting on the boiler.....	65
maximum limitation acting on the mixing valve in the heating circuit.....	64
maximum limitation of boiler temperature	54
maximum limitation of setpoint rise.....	51
maximum limitation of the flow temperature	51
maximum limitation of the rate of setpoint increase..	51
maximum limitation of the return temperature	64
maximum limitation of the room temperature.....	47
maximum selection common flow	75
mechanical design	121
minimum charging temperature solar	103
minimum limitation of the boiler temperature	54
minimum limitation of the flow temperature	51
minimum limitation of the return temperature	62
minimum limitation with mixing valve in the boiler return.....	64
minimum runtime collector pump	104
modulating burner	39, 57
mounting location.....	117
multifunctional relay	83
N	
no priority	75
nonoccupancy time	83

O	
occupancy time	83, 84
ON periods	87
open-circuit.....	27
operating instructions	115
operating line principle	116
operating lines	117
operating lines QAW70	112
operating mode continuously NORMAL heating	24
operating mode continuously REDUCED heating.....	24
operating state	26
operational level.....	26
optimization	43
optimum shut-down	45
optimum start control.....	45
optimum stop control.....	45
output relays.....	121
outside sensor	28
outside temperature	28
outside temperature source	96
outside temperature switch	83
overlapping heating periods	32
overriding of operating mode	93
overrun	80
overrun time	93

P	
parallel displacement	89
parallel displacement of heating curve.....	49
parallel operation.....	75
periodic pump run	94
periodicity of the legionella function	85
plant types.....	17, 18
protection	24
protection against boiler overtemperatures.....	59
protection against collector overheating.....	105
protection against discharging	80
protective boiler startup.....	58
protective startup.....	58
pulse lock	81
pulse lock heating circuit control	52
pump kick	94
pump M1	60
pump overrun	80, 93
pump overrun time	59

Q	
QAW70 operating lines	112
quick setback	45

R	
rail mounting.....	117

recooling storage tank (solar).....	105
reduction of the flow temperature setpoint	47
relay test.....	90
release integral for boiler sequence	40
release limit	55
reset integral for the boiler sequence	40
reset limit	55
return temperature.....	29
room influence.....	47
room model	27, 44
room model temperature	44
room temperature.....	27
room temperature deviation	47
room temperature sensor	27
room temperature setpoint boost	46
room temperature source	43
room unit QAW50.....	110
room unit QAW70.....	111

S

safety functions	54
sealing	121
selection of plant type.....	37
sensor test.....	90
service functions.....	88
setback of boiler setpoint.....	66
setpoint of holiday mode	32
setpoint of the common flow.....	75
setpoint return temperature limitation.....	61
setpoint rise	51
setpoints	32
setting buttons	116
setting knob for readjustments QAW70.....	111
setting levels.....	23, 116
setting ranges.....	122
shifting priority	74
short-circuit.....	27
simulation of the outside temperature	89
software version	101
solar radiation.....	99
solar sensor.....	31

source of solar radiation	99
source of time of day	95
storage tank recooling (solar)	105
storage tank temperature	30
Storage tank temperature maximum limitation	107
storage tank thermostat.....	77
storage temperature maximum limitation	105
stored heat.....	41
suitable actuators	14
suitable room units	14
suitable sensors.....	13
summertime.....	35, 94
switching differential of the d.h.w. temperature	77
switching program 2	35
switching program 3	87

T

technical data	122
temperature differential solar	102
test of contacts H.....	91
the composite outside temperature	41
time switch ON / OFF	84
TV1, TV2	89
type of heat source	38
type of limitation of return temperature.....	62
types of buildings.....	15
types of heating systems	15

U

uncritical locking signals	94
----------------------------------	----

V

voltage inputs	99
----------------------	----

W

wall mounting.....	117
wind sensor	31
wind speed	31, 100
winter- / summertime changeover	94
wintertime	35, 94
wiring	117

Siemens Switzerland Ltd
Building Technologies Group
International Headquarters
Gubelstrasse 22
CH – 6301 Zug
Tel. +41 41 724 24 24
Fax +41 41 724 35 22
www.sbt.siemens.com

© 2008 Siemens Switzerland Ltd
Subject to alteration

127/127