

# SIEMENS

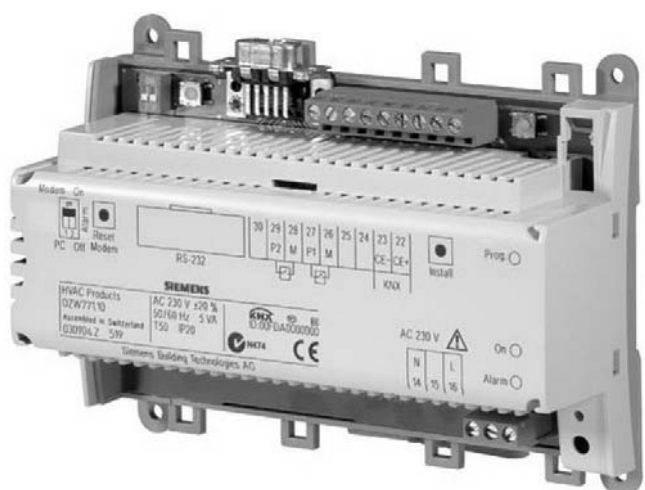

## Synco™ Central Communication Unit OZW771... Basic Documentation



Edition 1.10  
Version OZW771 1.10  
CE1P3117en  
15.09.2005

Building Technologies  
HVAC Products







Siemens Switzerland Ltd  
Building Technologies Group  
International Headquarters  
HVAC Products  
Gubelstrasse 22  
CH -6301 Zug  
Tel. +41 41 724 724 24 24  
Fax +41 41 724 724 35 22  
[www.sbt.siemens.com](http://www.sbt.siemens.com)









© 2004 Siemens Switzerland Ltd  
Subject to alteration



2/76

# Contents

---

<b>1</b>	<b>Summary .....</b>	<b>7</b>
1.1	Product range .....	7
1.2	Accessories .....	7
1.3	Synco™ topology .....	7
1.4	Equipment combinations .....	8
1.4.1	Synco™ devices .....	8
1.4.2	Plant operating software ACS7 .....	9
1.4.3	Konnex bus .....	9
1.5	Product documentation .....	9
1.6	Functions .....	9
1.7	Important notes .....	10
<b>2</b>	<b>Introduction.....</b>	<b>11</b>
2.1	Communication links .....	11
2.1.1	General .....	11
2.1.2	Communication via Konnex bus .....	11
2.1.3	Communication via RS-232 port .....	12
2.1.4	Communication via the telephone network .....	13
2.2	Operating elements of the central communication unit .....	14
2.3	Terms and symbols .....	15
<b>3</b>	<b>Local commissioning of the central communication unit .....</b>	<b>18</b>
3.1	Prerequisites .....	18
3.2	Preparations .....	18
3.3	Creating the device list .....	18
3.4	Restoring the default state .....	19
<b>4</b>	<b>Commissioning the central communication unit with ACS7... software .....</b>	<b>20</b>
4.1	 Commissioning .....	20
4.1.1	Introduction .....	20
4.1.2	Prerequisites .....	20
4.1.3	Preparations .....	20
4.1.4	Starting the ACS .....	21
4.2	 Central communication unit .....	22
4.3	 Communication .....	24
4.3.1	 Konnex .....	24
4.3.2	Clock function .....	24
4.3.3	 Modem .....	25
4.3.4	Fundamentals of modem entries .....	26
4.4	 Device list .....	27

4.4.1	General information about the device list.....	27
4.4.2	Generating the device list .....	27
4.4.3	Updating device information .....	29
4.4.4	Editing the device list .....	29
4.4.5	 Device 1, device 2, etc. ....	30
4.5	 Message receivers .....	32
4.5.1	Fundamentals .....	32
4.5.2	Modem connection.....	32
4.5.3	Receiver type .....	32
4.6	 Faults.....	37
4.6.1	Fault inputs .....	37
4.6.2	Central communication unit .....	38
4.6.3	Konnex.....	39
4.7	 System report .....	39
4.8	 Text .....	40
4.9	Replacement of central communication unit.....	41
<b>5</b>	<b>Completing commissioning.....</b>	<b>42</b>
5.1	Central communication unit and connections .....	42
5.2	Wiring the fault inputs .....	42
<b>6</b>	<b>Plant operation.....</b>	<b>43</b>
6.1	Fault indication on the central communication unit.....	43
6.2	Faults and messages.....	43
6.2.1	Faults on the plant and their messages .....	43
6.2.2	System report of plant.....	43
6.3	Representation of messages .....	43
6.3.1	Fault status messages to ACS Alarm .....	43
6.3.2	Fault status messages to mobile phone (SMS) .....	46
6.3.3	Fault status messages to pager.....	48
6.3.4	Fault status messages to other receivers .....	51
6.3.5	System report to the ACS .....	52
6.3.6	System report to mobile phone (SMS).....	53
6.3.7	System report to pager .....	53
6.3.8	System report to other receivers.....	54
6.4	Plant operation with ACS7... ..	54
6.4.1	Creating a new plant with ACS Operation .....	55
6.4.2	Updating an existing plant.....	56
6.5	 Inputs.....	57
6.6	 Time of day / date.....	57
6.6.1	System time fault .....	57
6.7	 Faults.....	58
6.7.1	Fault inputs .....	58
6.7.2	Central communication unit .....	58
6.7.3	Konnex.....	59
6.7.4	 Device 1, device 2, etc. ....	60

6.7.5	Fault handling through the central communication unit .....	62
6.8	Message receivers .....	63
6.8.1	Functions .....	63
6.8.2	Modem connection .....	63
6.8.3	Substitution of characters in text messages .....	65
6.9	 Device information .....	67
6.9.1	 Central communication unit .....	67
6.9.2	 Konnex .....	68
6.10	Behavior when turning power on and off .....	68
6.10.1	Sequence of functions when turning power on .....	68
6.10.2	Data storage when turning power off .....	69
6.11	Quick onsite checks .....	69



# 1 Summary

## 1.1 Product range

Name	Type reference	Data Sheet no.
Central communication unit for 4 Synco™ devices	<b>OZW771.04</b>	N3117
Central communication unit for 10 Synco™ devices	<b>OZW771.10</b>	N3117
Central communication unit for 64 Synco™ devices	<b>OZW771.64</b>	N3117

## 1.2 Accessories

Name	Ordering no.	Data Sheet no.
Terminal covers	<b>74 111 0028 0</b>	N3117

The terminal covers are mandatory if the device is mounted outside the control panel or cabinet.

Supply of the terminal covers includes the covers for the mains and the low-voltage side as well as the cable ties for fixing.

## 1.3 Synco™ topology

For the topologies depicted below, following applies:

- Several central communication units can be connected to the Konnex bus in parallel
- The central communication unit can and should be put into operation with the help of the OCI700.1 service tool

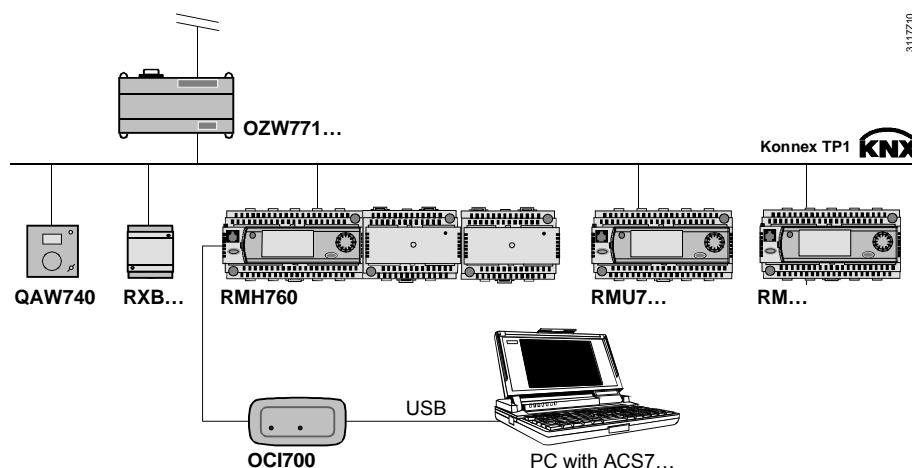

Topology of a Synco™ plant including the central communication unit at the time of commissioning with the OCI700 service interface.

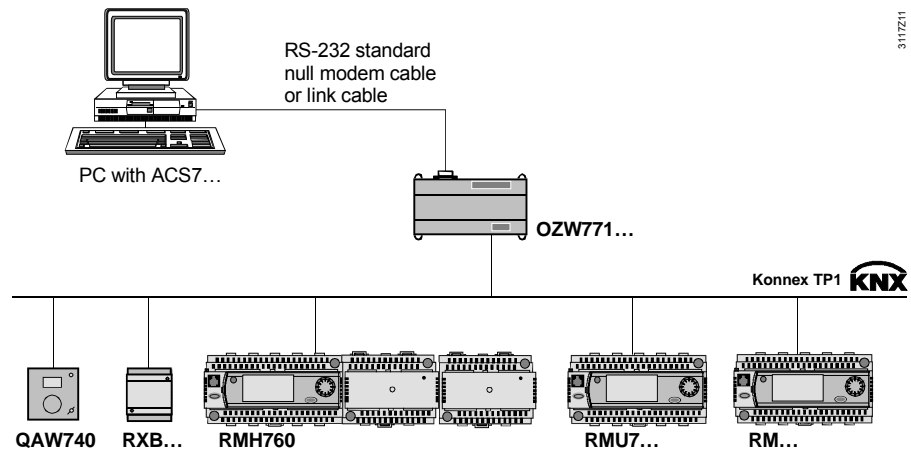

Topology of a Synco™ plant in operation, with direct communication via RS-232.

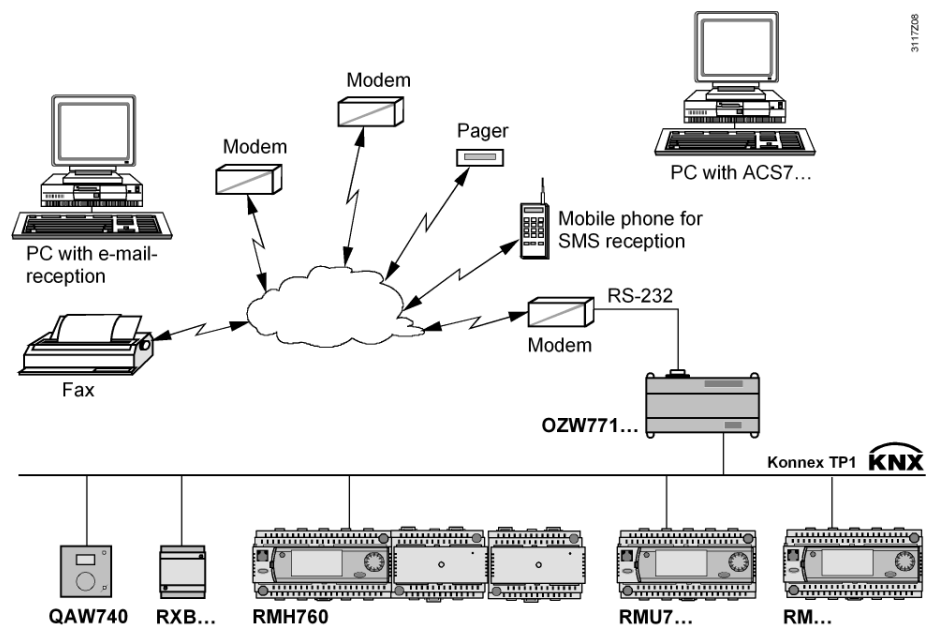

Topology of a Synco™ plant in operation, with communication via modems and the telephone network.

## 1.4 Equipment combinations

### 1.4.1 Synco™ devices

The following types of Synco™ devices with Konnex bus connection facility can be connected to the central communication unit:

- Heating controllers RMH7... and RMK7...
- Universal controllers RMU7...
- Central control units RMB7...
- Room units QAW7...
- Individual room controllers RXB... (only those with the Konnex logo)
- Service tool OC1700.1

The Synco™ family of devices is continuously extended. For an overview of the Synco™ family of products, refer to the following documentation:

Type of document	Classification no.
Product range description "HVAC controllers with Konnex interface"	<b>S3110</b>



## 1.4.2 Plant operating software ACS7...

With the ACS7... plant operating software installed, a PC can be used as an operator station:

- Connected to the Konnex bus interface via the OCI700 service interface
- Connected to the RS-232 port, either directly or via modem

For detailed descriptions of the ACS7... plant operating software, refer to the following pieces of documentation:

<i>Type of document</i>	<i>Classification no.</i>
Data Sheet "Plant operating software ACS7..."	<b>N5640</b>
Operating Instructions "Operating software, service software"	<b>U5640</b>
Operating Instructions "Alarm software"	<b>U5641</b>
Operating Instructions "Batchjob software"	<b>U5642</b>

## 1.4.3 Konnex bus

For detailed information about the Konnex bus, refer to the following pieces of documentation:

<i>Type of document</i>	<i>Classification no.</i>
"Konnex bus KNX"	<b>P3127</b>
Data Sheet "Konnex bus KNX"	<b>N3127</b>
Engineering Instructions "Konnex S-mode datapoints"	<b>Y3110</b>

## 1.5 Product documentation

<i>Type of document</i>	<i>Classification no.</i>
Data Sheet no.	<b>N3117</b>
Basic Documentation	<b>P3117</b>
Installation Instructions	<b>G3117</b>
Environmental Declaration	<b>E3117</b>
Declaration of Conformity (CE)	<b>T3117</b>

## 1.6 Functions

The central communication unit:

- Identifies connected Synco™ devices via the automated search run
- Facilitates direct access to the Synco™ devices with the help of an operator station connected either directly or via modem
- Monitors the Synco™ devices and 2 fault inputs for potential-free contacts
- Signals faults to a PC, either directly or via modem
- Signals faults to SMS receivers, fax machines\*, pagers and e-mail receivers\* via modem
- Provides a clock function for signaling faults
- Supports the function of a system clock and that of a clock time master

\* Only possible with GSM modem, depending on the telephone provider

## 1.7 Important notes

---



This symbol draws your attention to special safety notes and warnings. If such notes are not observed, personal injury and / or considerable damage to property can occur.

<b>Field of use</b>	Synco™ products may only be used for the control and supervision of heating, ventilation, air conditioning and chilled water plant.
<b>Correct use</b>	Prerequisites for flawless and safe operation of Synco™ products are proper transport, installation and commissioning, as well as correct operation.
<b>Electrical installation</b>	Fuses, switches, wiring and earthing must be in compliance with local safety regulations for electrical installations.
<b>Commissioning</b>	Preparation for use and commissioning of Synco™ products must be undertaken by qualified staff who have been appropriately trained by Siemens Building Technologies.
<b>Operation</b>	Synco™ products may only be operated by staff who have been instructed by Siemens Building Technologies or their delegates and whose attention has been drawn to potential risks.
<b>Wiring</b>	When wiring the system, the AC 230 V section must be strictly segregated from the AC 24 V safety extra low-voltage (SELV) section in order to ensure protection against electric shock hazard!
<b>Storage and transport</b>	For storage and transport, the limits given in the relevant Data Sheets must always be observed. If in doubt, contact your supplier or Siemens Building Technologies.
<b>Maintenance</b>	Synco™ products are maintenance-free, apart from cleaning at regular intervals. System sections accommodated in the control panel should be freed from dust and dirt whenever normal service visits are due.
<b>Faults</b>	Should system faults occur and you are not authorized to make diagnostics and to rectify faults, call the service staff of Siemens Building Technologies.
	 Only authorized staff are permitted to make diagnostics, to rectify faults and to restart the plant. This also applies to work carried out within the control panel (e.g. safety checks or changing fuses).
<b>Disposal</b>	The products contain electrical and electronic components and must not be disposed of together with domestic waste. <b>Current local legislation must be observed.</b>

## 2 Introduction



Synco™ devices may only be operated by staff who have been instructed by Siemens Building Technologies or their delegates and whose attention has been drawn to potential risks.

The OZW771 central communication unit can be operated via the ACS7... plant operating software, either locally or with a PC.

### 2.1 Communication links

#### 2.1.1 General

Parameterization of the central communication unit and its operation can take place from a PC which is used as a central operator station. For that purpose, the ACS7... plant operating software must be installed on the PC.

The central communication unit can communicate with the PC as follows:

- Via Konnex with the help of the OCI700 service interface
- Directly via the RS-232 port. In that case, a standard null modem cable or link cable between PC and central communication unit is required
- With a modem via the public telephone network

#### 2.1.2 Communication via Konnex bus

The service or operating software facilitates direct data exchange with the Konnex bus users (Synco™ devices) via the PC's USB port and the service interface. We recommend to commission the central communication unit using this type of data exchange.

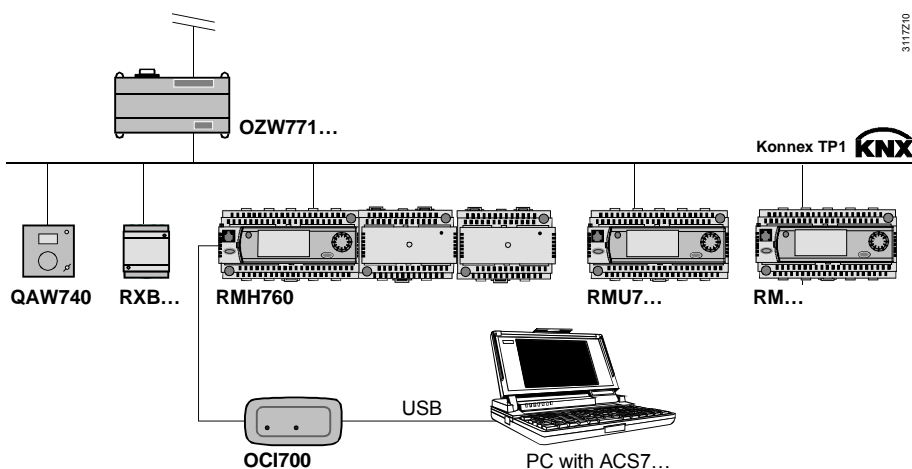

## 2.1.3 Communication via RS-232 port

### Connection

The direct connection necessitates a standard null modem between central communication unit and PC.

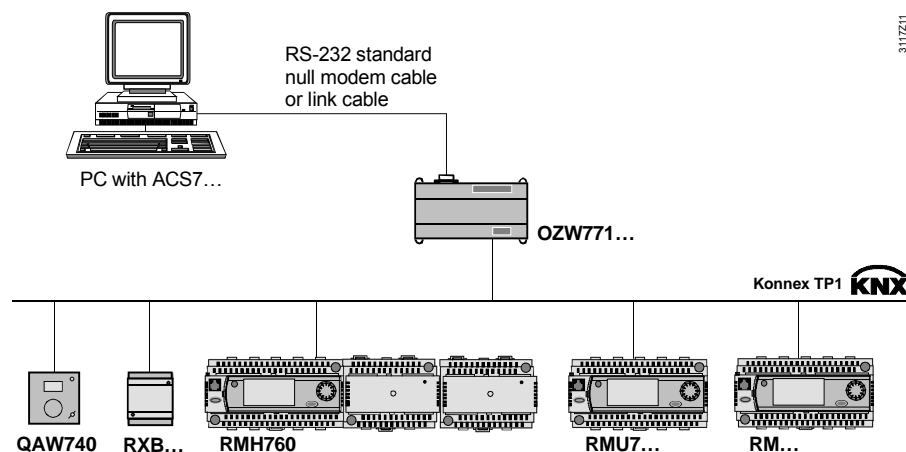

### Standard null modem

There are 2 types of cable available.

Standard null modem cable				Link cable			
9 pins		9 pins		9 pins		9 pins	
Female Terminal 1	Female Terminal 2	Female Terminal 1	Female Terminal 2	Female Terminal 1	Female Terminal 2	Female Terminal 1	Female Terminal 2
TD (3)	(3)	TD (3)	(3)	TD (3)	(3)	TD (3)	(3)
RD (2)	(2)	RD (2)	(2)	RD (2)	(2)	RD (2)	(2)
RTS (7)	(7)	RTS (7)	(7)	RTS (7)	(7)	RTS (7)	(7)
CTS (8)	(8)	CTS (8)	(8)	CTS (8)	(8)	CTS (8)	(8)
DSR (6)	(6)	DSR (6)	(6)	DSR (6)	(6)	DSR (6)	(6)
GND (5)	(5)	GND (5)	(5)	GND (5)	(5)	GND (5)	(5)
DCD (1)	(1)	DCD (1)	(1)	DCD (1)	(1)	DCD (1)	(1)
DTR (4)	(4)	DTR (4)	(4)	DTR (4)	(4)	DTR (4)	(4)

5963Z10

5963Z11

Both types of cable can be used.

## 2.1.4 Communication via the telephone network

### Connection

In the case of communication via the telephone network, the combinations contained in the following table must be taken into consideration.

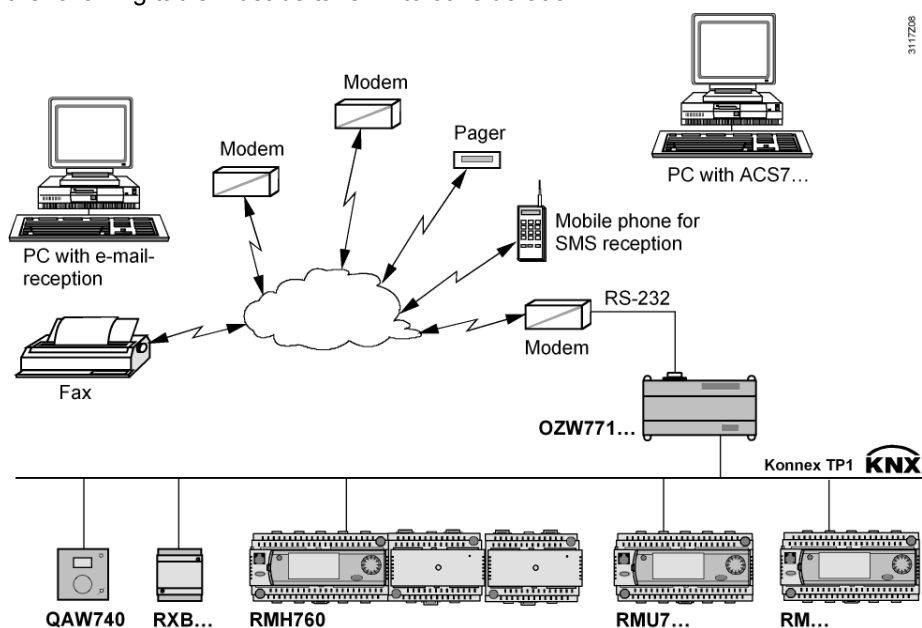

3117206

### Modem and protocol support

<i>Message receiver</i>	<i>Protocol support of the telephone provider</i>	<i>Type of modem required</i>
PC with ACS	No special requirements	Hayes-compatible analog, ISDN or GSM modem
SMS receiver	Fixed network provider which supports the UCP or the TAP protocol	
Pager	Fixed network provider which supports the TAP protocol	GSM modem (e.g. Siemens TC35)
SMS receiver	GSM telephone provider	
Fax machines	GSM telephone provider which supports the redirection of short messages to fax machines	
Pager	GSM telephone provider which supports the redirection of short messages to pagers	
E-mail receiver	GSM telephone provider which supports the redirection of short messages to e-mail receivers	

## 2.2 Operating elements of the central communication unit

In contrast to the Synco™ 700 controllers, the OZW771 central communication unit has no clear-text display. It features the following indicating and operating elements:

- 1 DIP switch
- 3 LEDs
- 2 buttons

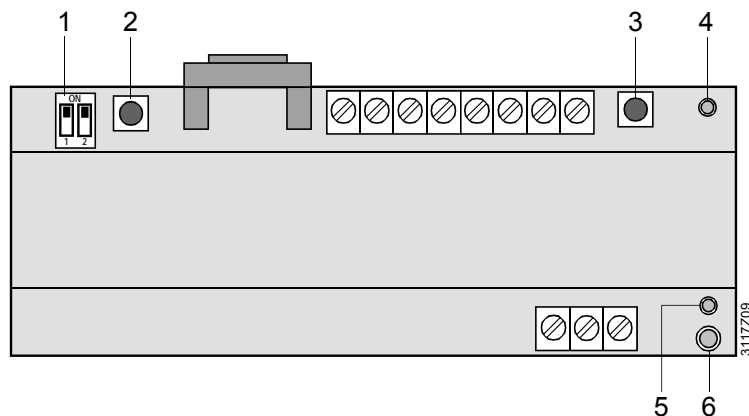

- 1 RS-232 selector S1: "Modem" / "PC"  
Message selector S2 "Alarm": "On" / "Off"
- 2 Modem reset button "Reset Modem"
- 3 Konnex bus button "Install"
- 4 Program LED "Prog" (red)
- 5 Operation LED "On" (green)
- 6 Fault LED "Alarm" (red)

### RS-232 selector S1

The RS-232 selector has 2 positions: "Modem" and "PC".

It is used to select the way the central communication unit's RS-232 port will be connected:

**Modem** = connection via modem

**PC** = direct connection to a PC

### Message selector S2

The unit's message selector is marked "Alarm" and has 2 positions: "On" and "Off".

It is used to select whether or not pending faults or system reports shall be delivered to the message receiver.

**On** = deliver

**Off** = do not deliver

### Modem reset button

The modem reset button "Reset Modem" is used to reinitialize the modem.

Initialization takes place by pressing the button for more than 6 seconds.

After initialization, the central communication unit opens a connection to all parameterized message receivers and delivers a system report. This system report is always delivered to all parameterized message receivers, independent of the current parameterization of the system report.

### Konnex bus button

The Konnex bus button is marked "Install".

- The device list is generated by pressing the button for more than 6 seconds
- The change from normal mode to programming mode for adopting the device address from the ETS is made by pressing the button for less than 2 seconds

The central communication unit changes to programming mode only if power is available on the Konnex bus. This way, the correct functioning of the Konnex bus can be checked.

## Programming LED

The red programming LED, marked “Prog”, indicates whether the central communication unit is in programming mode:

- LED dark: Normal mode
- LED lit: Programming mode

The LED extinguishes when the device address from the ETS (EIB Tool Software) has been adopted.

## Operation LED

The green operation LED is marked “On” and indicates the relevant operating state of the central communication unit:

- LED dark: No mains voltage
- LED lit: Mains voltage present
- LED flashes: Communication via RS-232 port

## Fault LED

The red fault LED is marked “Alarm” and indicates faults in the plant:

- LED dark: No fault
- LED lit: 1 or several Synco™ devices on the Konnex bus faulty
- LED flashes: Fault at the fault inputs or internal fault of the central communication unit

## 2.3 Terms and symbols

### Device view

In addition to the central communication unit, the device view shows the Synco™ devices entered on the device list as device 1, device 2, etc. On the device view, these devices (device addresses 107 and 56 in the example) follow the central communication unit (device address 253 in the example).

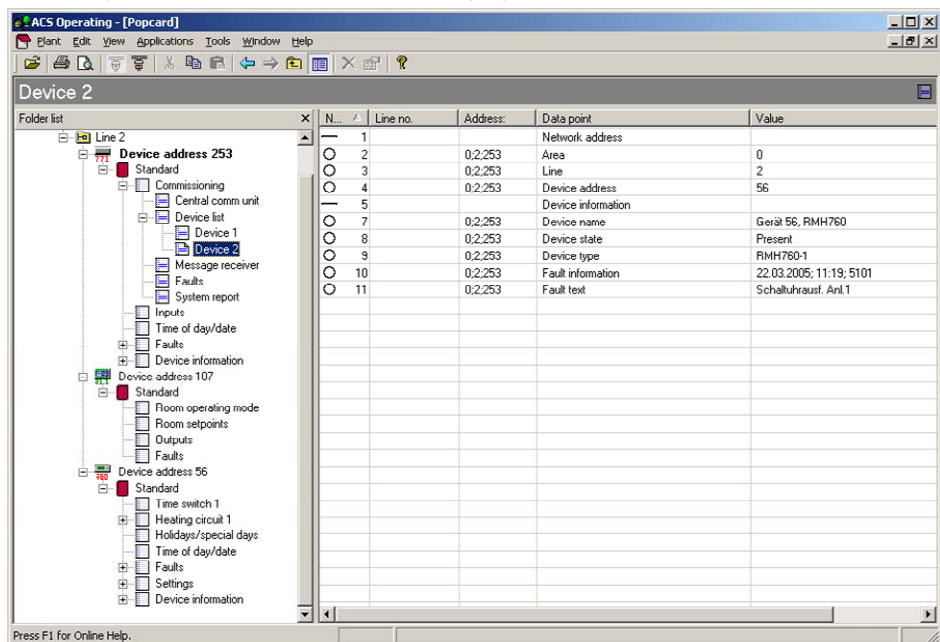

Representation of the central communication unit and the Synco™ devices in the form of a menu tree.

### Menu tree

For each device, the datapoints are shown on different operating pages  of a menu tree. To simplify operation, the operating pages are assigned to different operating levels. Each operating page can contain several datapoints.

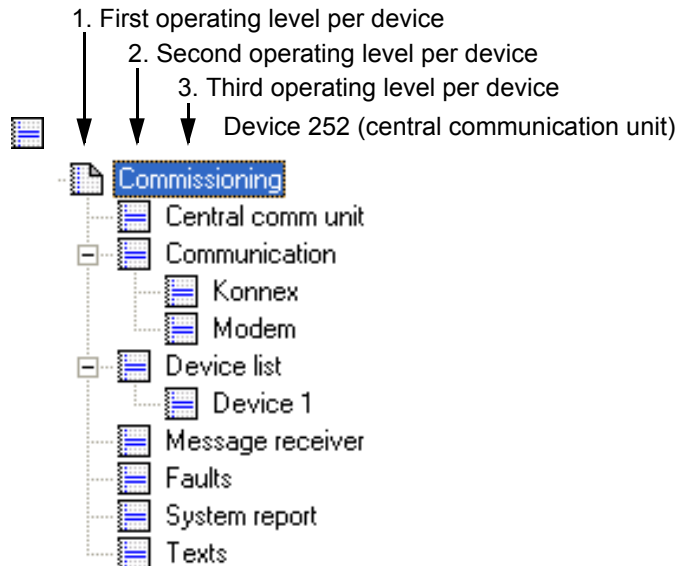

**Definition of “datapoint”**

Datapoint in this document is referred to as a value that can be displayed and / or readjusted with the ACS7... plant operating software.

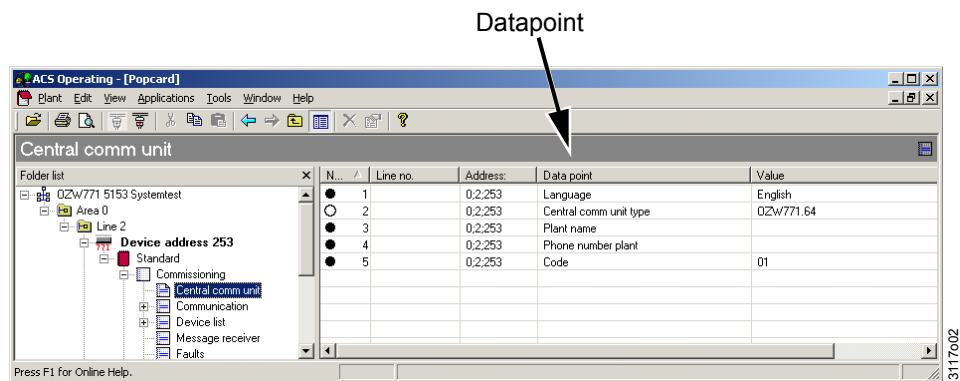

**User levels**

The datapoints can be viewed and adjusted depending on the user level selected with the ACS7... software. The following user levels are available:

- Administrator
- Service
- Enduser

**Example “Service level”**

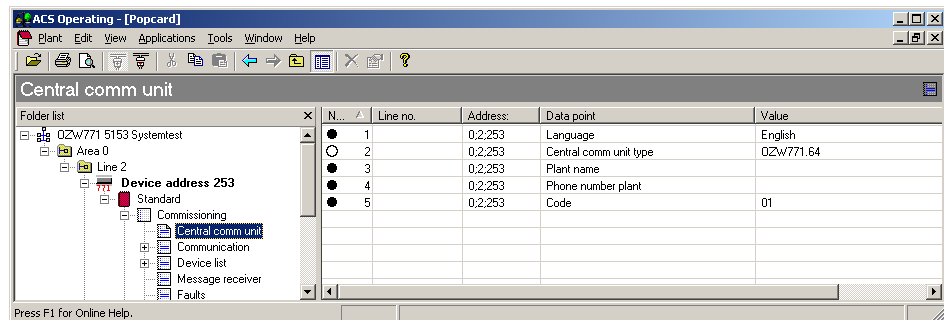

**Service level (ACS view, menu tree, central communication unit).**

The service engineer can access 5 datapoints 4 of which can be changed.



## Example “Enduser level”

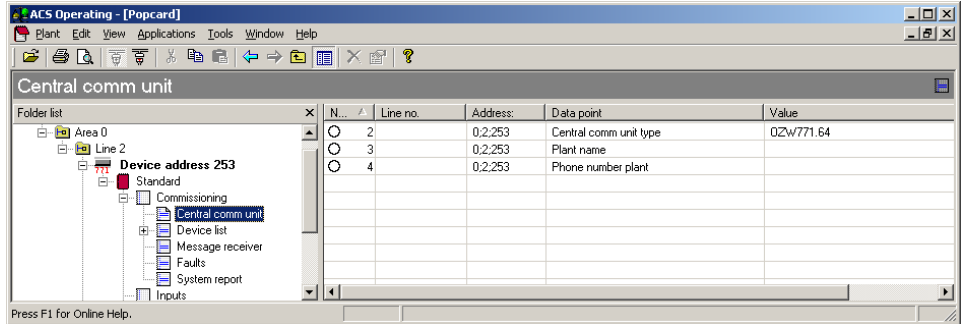









### Enduser level (ACS view, menu tree, central communication unit)

The enduser can access 3 datapoints; none of them can be changed.

## Symbols

The symbols used with the datapoints have the following meaning:

-  = datapoint on the service level
-  = datapoint on the enduser level
-  = write-and-read datapoint; setting can be changed
-  = reference write-and-read datapoint; setting can be changed; other datapoints are displayed depending on this setting
-  = read only datapoint; setting cannot be changed
-  = reference read only datapoint; other datapoints are displayed depending on this value
-  = operating page of the unit's first operating level
-  = operating page of the unit's second and third operating level

## Information about datapoints

Datapoint designations, inputs and displays are represented as follows in current text:  
Update device list

## Information about paths

Paths are shown as follows:

- In the menu tree: Commissioning > Device list > Create device list
- On the ACS main menu: **Plant > Update device list**

## Buttons

Buttons are represented as follows: 

# 3 Local commissioning of the central communication unit



## Important

Local commissioning of the central communication unit must take place **prior** to commissioning the plant with the help of the ACS software.

## 3.1 Prerequisites

- All Synco™ devices on the Konnex bus have been put into operation
- The Konnex network addresses of the Synco™ devices are already assigned
- Plant is in operation, or is ready to operate (power is supplied to all devices, etc.)
- Neither the central communication unit nor the OCI700 service interface powers the bus. To facilitate communication, either the necessary number of Synco™ devices or central bus power supply must be available on the bus
- For topology, refer to section 1.3 “Synco™ topology”

## 3.2 Preparations

1. Do NOT turn on power yet.
2. Remove terminal covers, if fitted.
3. Check wiring according to the plant connection diagram; the Konnex bus must be connected! Also refer to Installation Instructions G3117.
4. For the modem connection according to subsection 2.1.4 “Communication via the telephone network”, connect the modem to the central communication unit’s RS-232 port. Connection to the telephone network must be ensured. For direct connections according to subsection 2.1.3 “Communication via RS-232 port”, the PC must be connected
5. For **commissioning**, RS-232 selector S1 must be set to “PC”  (direct communication with PC via RS-232 port).
6. For **commissioning**, message selector S2 must be set to “Off”  (no delivery of messages via RS-232 port).
7. Replace terminal cover on the mains voltage side, if required.
8. Turn on power.

## 3.3 Creating the device list

When pressing the Konnex bus button for at least 6 seconds, the central communication unit will create the device list. All the devices acquired are on the same line.

- During the time this function is performed, the operation LED is dark (item 5 in the illustration in section 2.2 “Operating elements of the central communication unit”). The central communication unit shows the end of the device search run only when all other data have been queried also. Then, the operation LED flashes 3 times
- If the device address of the central communication unit is still in the default state, the unit will choose function “Identify device address automatically” (refer to subsection 4.3.1  “Konnex”)
- Then, the central communication unit queries all users on the Konnex bus together, each of them responds.  
During the search run, the Synco™ devices identified are only those connected to the same line as the central communication unit and responding correctly. Third-party devices including line couplers do not respond.  
The device list is generated based on the responses received from the users
- If the central communication unit does not yet contain a device list, it will be created in the order the responses are received

- If a device list already exists in the central communication unit, the responses are compared with the device addresses of the existing entries and overwritten if they agree. In case there is no agreement, the device will be newly added to the device list. New devices are first inserted in the “gaps” (devices having the not checked state; refer to subsection 4.4.5 “ Device 1, device 2, etc.”) and only then added at the end – if there is sufficient space

The device search run is active for:

- At least 15 seconds
- A maximum of 5 seconds after reception of the last response to the query. The time of the last response depends on the current bus load

When the device list is generated, the remaining data of the device list will automatically be updated.

For details, refer to subsection 4.4.3 “Updating device information”.

Devices contained on the device list that do not respond to the query made by the central communication unit will be given the “not present” state.

The number of devices that can be entered are limited (also refer to subsection 4.4.2 “Generating the device list”). When the maximum number is reached, responses from bus users that have not yet been handled will not be considered.

Pressing the Konnex bus button again for 6 seconds during the time a search run is active (operation LED dark) has no impact; the command will be ignored.

### 3.4 Restoring the default state

---

The default (as supplied) state of the central communication unit can be restored.

When simultaneously pressing the modem reset button **and** the Konnex button for 6 seconds, all adjustable values will be reset to their default values. This also applies to S-mode datapoints. The green LED extinguishes and the central communication unit will be restarted. After a successful fresh start, the green LED will be lit again.

# 4 Commissioning the central communication unit with ACS7... software

## 4.1 Commissioning

### 4.1.1 Introduction

---

Commissioning by the heating engineer – including the relevant parameter settings – and plant **operation** by the enduser are made possible via the ACS menu (Applications > Popcard...).

A detailed description of commissioning and operation of the Synco™ plant with the OZW771 central communication unit via ACS7... is given in the following subsections. For other functions provided by the ACS (e.g. Trend), refer to the relevant ACS documentation.

#### Note on "Parameter settings" menu

The ACS menu (Applications > Parameter settings...) is used for loading and reading entire parameter sets of the central communication unit and of the Synco™ devices connected to the Konnex bus.

### 4.1.2 Prerequisites

---

- Local commissioning of the central communication carried out according to chapter 3 "Local commissioning of the central communication unit"
- It is assumed that the user is more or less familiar with the ACS7... plant operating software

### 4.1.3 Preparations

---

- Commissioning is made with a PC which must have the ACS7... plant operating software installed. Detailed information about the installation is given in the relevant pieces of documentation
- For commissioning the central communication unit, the user must have logged in on the "Service" user level
- The PC with the installed ACS7... plant operating software is to be connected to the Konnex bus via the OCI700 service interface (connected via USB, refer to subsection 2.1.2 "Communication via Konnex bus")
- The OCI700 service interface must be connected to the same line as the central communication unit

## 4.1.4 Starting the ACS

1. Start ACS Service and log on with the service password.
2. Plant > New > Plant...
3. The "Save As" dialog opens.  
Enter the file name (e.g. Building WEST)

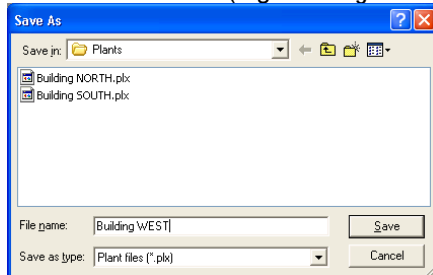

4. Select **Save** :  
The "General" dialog opens.

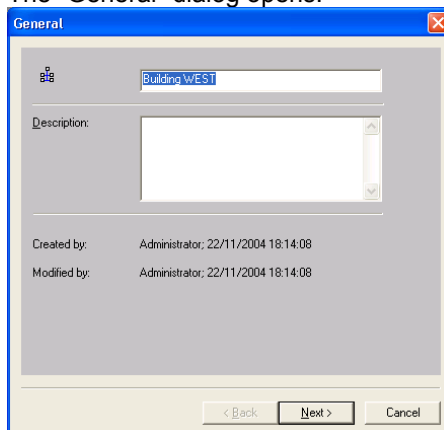

5. Select **Next >** :  
The "Communication" dialog opens

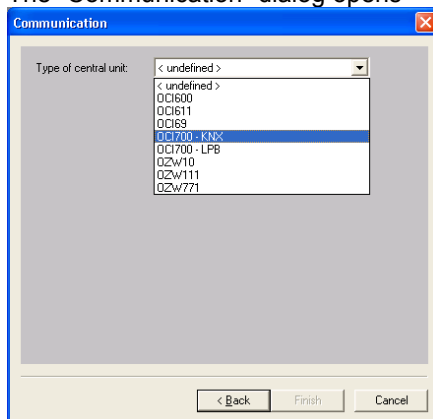

6. Select the type of central unit: OCI700 - KNX

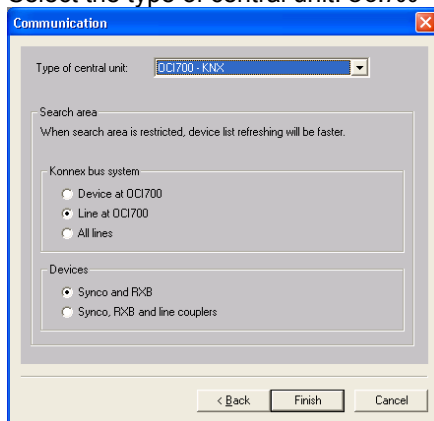

7. Adopt the remaining settings (as supplied).

Select **Finish**

8. **Plant > Connect** (or  on the menu bar).

9. **Plant > Update device list**. What follows are the displays “Read plant information” and “Update reference data points”.

If an address is used several times, this problem must be solved first. For details, refer to section 3.1 “Prerequisites” and subsection 4.1.2 “Prerequisites”.

10. Choose **Applications > Popcard...**

11. Extend view of tree structure until OZW771 appears.



12. Extend view of  **Standard** and  **Commissioning**, enabling the relevant application pages to appear.

From here, commissioning follows the menu tree in ACS. The menu tree is made up such that when commissioning the plant, every branch or datapoint on the tree can be retrieved and parameterized in a practical way from top to bottom.

## 4.2 Central communication unit

### Datapoints

The following settings can be made on the central communication unit:

<i>Datapoint</i>	<i>Explanation, example</i>		
Language	Refer to paragraph “Selecting the language” below	<input checked="" type="radio"/>	<input type="radio"/>
Type of central communication unit	Here, the complete type reference is shown: OZW771.04 = max. 4 Synco™ devices on the bus OZW771.10 = max. 10 Synco™ devices on the bus OZW771.64 = max. 64 Synco™ devices on the bus	<input type="radio"/>	<input type="radio"/>
Plant name	Maximum 20 digits. Example: Main street 22 This entry is made for information purposes and contained in a number of messages delivered by the central communication unit. Observe the notes!	<input checked="" type="radio"/>	<input type="radio"/>
Phone number plant	Maximum 20 characters. This number is used for information purposes and sent out as text in messages. Therefore, any kind of text can be entered here. If messages are sent to numerical pagers, only digits are permitted here. Observe the notes!	<input checked="" type="radio"/>	<input type="radio"/>
Code	Maximum 20 digits. For more details, refer to paragraph “Code” below.	<input checked="" type="radio"/>	<input type="radio"/>

Notes on datapoints Plant name and Phone number plant

- Exercise caution when using pagers; pay attention to the relevant notes given under “Receiver type = pager“ in subsection 4.5.3 “Receiver type”
- A detailed description of the entries is given in section 6.3 “Representation of messages”

### Selecting the language

On the central communication unit, Text is available in several languages. The required language is to be entered when commissioning the plant. It is recommended to select the same language as that used with the Synco™ devices on the Konnex bus. The language can also be changed later during operation.

At present, the central communication unit supports the following languages:

- English
- German
- French
- Italian
- Dutch
- Polish
- Czech
- Hungarian
- Spanish
- Danish
- Norwegian
- Swedish
- Finnish
- Slovakian

User-defined text

If a new language is selected, all user-defined text in the previous language will be lost. In that case, the words of the newly selected language available in the default state will be used. This applies to the following datapoints:

<i>Datapoint</i>	<i>Path in ACS menu tree</i>
Text fault input 1	Commissioning > Faults
Text for: No fault	Commissioning > Faults
Text for: Fault	Commissioning > Faults
Text fault input 2	Commissioning > Faults
Text for: No fault	Commissioning > Faults
Text for: Fault	Commissioning > Faults
Device	Commissioning > Texts > Text for...
Inputs	Commissioning > Texts > Text for...
No fault	Commissioning > Texts > Text for...
Faults	Commissioning > Texts > Text for...
System report	Commissioning > Texts > Text for...
Device failure	Commissioning > Texts > Text for...

### Code

The central communication unit is supplied with the code preset to 01. The code entered here must agree with that of the ACS plant.

The setting can only be made after the ACS plant has been created, either via modem or a direct connection (refer to section 6.4 “Plant operation with ACS7...”, step 7). The setting is made either directly in the dialog or via the ACS menu at a later stage.

Caution



If the 2 codes do not agree, the central communication unit refuses to open the connection. If the connection cannot be opened and the code of the central communication unit is not known, the following procedure is recommended:

1. Connect the ACS via OCI700.
2. Set the OZW771 code to the required value.
3. Disconnect the ACS via OCI700.
4. Build up the connection again with the ACS.



## 4.3 Communication

### 4.3.1 Konnex

#### Datapoints



<i>Datapoint</i>	<i>Explanation, example</i>		
Identify network address automatically	If local commissioning has been made correctly (device search run by a long press of the Konnex button "Install"), the central communication unit has already performed this function!	<input checked="" type="radio"/>	–

To ensure that ACS can still address the central communication unit correctly, the Pop-card must be closed and, on the ACS main menu, command `Plant > Update device list` must be chosen **after** function Identify device address automatically has been performed. If Yes is entered here, the central communication unit will identify a free network address. If available, both area and line will be adopted from the overriding line coupler. Then, the central communication unit searches for the next free device address from 253 downward. When a free device address is found, the datapoint will be set to No.

<i>Datapoint</i>	<i>Explanation, example</i>		
Area	The area is part of the network address; it is automatically adopted from the overriding line coupler	<input type="radio"/>	–
Line	The line is part of the network address; it is automatically adopted from the overriding line coupler	<input type="radio"/>	–
Device address	The device address is part of the network address and, if local commissioning has been made correctly, has already been assigned by function Create device list or Identify device address automatically	<input type="radio"/>	–

### 4.3.2 **Clock function**

#### Datapoints

<i>Datapoint</i>	<i>Explanation, example</i>		
Clock time operation	The following entries can be made: <ul style="list-style-type: none"> <li>• Autonomous</li> <li>• Slave</li> <li>• Master</li> </ul> If Slave is selected, Remote setting clock slave must be configured (Yes / No)	<input checked="" type="radio"/>	–
Remote setting clock slave	To be set if clock time operation = slave Configuration: Remote setting Yes / No	<input checked="" type="radio"/>	–

#### Clock time operation

The clock function of the central communication unit offers 3 choices for clock time operation:

- Configuration as a master:

The clock in the central communication unit works as a system clock and acts on all devices on the Konnex bus where the clock has been configured as a slave.

If, in addition to the central communication unit, there is another master on the Konnex bus, it generates fault 5002 (>1 clock time master) and no longer delivers its system time.

If the time of day cannot be changed on the central communication unit, there is another master with a higher priority (lower device address) in the system



- Configuration as a slave:  
The clock in the central communication unit will be synchronized with the master's clock. If there is no master, fault 5001 (system time failure) will be generated
- Configuration as Autonomous:  
The time of day is neither adopted by a master nor sent to other devices on the Konnex bus

### Remote setting clock slave

In the case of clock time operation as a slave on the central communication unit, function Remote setting clock slave enables the operator to set the master's time of day and date from a remote location.

For that purpose, datapoint Remote setting clock slave must be set to Yes.









### Time data

If the central communication unit is configured as Clock time master or Autonomous, the setting of time data is mandatory. These settings are made on the Time of day/date menu. Weekday, month, day of month and year, as well as start and end of summer-time, are set with the help of a calendar.

### 4.3.3 Modem

If the telephone network shall be used for the connection between ACS and central communication unit, the settings for the type of modem used must be made.

### Datapoints

Datapoint	Explanation, example		
Modem type	Following choices are available: <ul style="list-style-type: none"> <li>• Analog (as supplied)</li> <li>• ISDN</li> <li>• GSM</li> </ul>		–
Baud rate RS-232	The RS-232 port offers default rates from 1.2 kBd to 115.2 kBd. Default state in modem operation: 9.6 kBd. If RS-232 selector S1 is set to "PC", the Baud rate is always 9.6 kBd		–
Reset command	The default setting is ATZ^M, independent of the type of modem selected		–
Initialization command	The default setting is ATE0V0L1&C1&D2S0=2^M, independent of the type of modem selected		–
Command opening connection	When selecting the type of modem, this value will be overwritten with the following values: <ul style="list-style-type: none"> <li>• Analog: ATDT (as supplied)</li> <li>• ISDN: ATD</li> <li>• GSM: ATD</li> </ul>		–
Command abortion connection	When selecting the type of modem, this value will be overwritten with the following values: <ul style="list-style-type: none"> <li>• Analog: ~~~~~ATH0^M (as supplied)</li> <li>• ISDN: ~~~~~ATH^M</li> <li>• GSM: ~~~~~ATH^M</li> </ul>		–
Command closure	The default setting is ^M, independent of the type of modem selected		–

If the modem does not respond to a command, or if it gives a negative response, the central communication unit will return to the ready state after a certain waiting time has elapsed. In that case, fault status message No modem communication will be delivered.

The manual of the modem used contains the relevant specification (also refer to sub-section 4.3.4 "Fundamentals of modem entries").

The majority of the default entries are set by the selected modem type and are suited for most types of modem. They can be reset to the default settings at any time. Double-click on the line of the datapoint and select the **Default** button.

When changing the selected modem type, the datapoints will be reset to their default values.

Note

When using a GSM modem, RS-232 selector S1 must be set to "Modem" now (prior to commissioning the message receivers).

### 4.3.4 Fundamentals of modem entries

#### AT command sets

<i>Command set</i>	<i>Purpose of command</i>
AT	Informs the modem that modem commands will follow. This is how each command line must begin
M	Sends the command closure to the modem. This is a control code which the modem usually interprets as "carriage return"
+++	Quits the data transfer mode and changes to the command mode (Escape Code)

#### Typical AT commands

<i>Command</i>	<i>Purpose of command</i>
D	Dialing the phone number (followed by the phone number)
DT...	Dialing the phone number with tone dialing (followed by the phone number)
DP...	Dialing the phone number with pulse selection (followed by the phone number)
<b>E0</b>	No command echo. Required for OZW771
E1	Echo command character
H	Disconnect, hang up (ISDN, GSM)
H0	Disconnect, hang up (analog)
<b>L1</b>	Loudspeaker soft
<b>Q0</b>	Result code sent. Required for OZW771
Q1	Silent (no result codes)
<b>S0=2</b>	Pick up the phone after ringing twice
<b>V0</b>	Numerical replies (e.g. 0). Required for OZW771
V1	Replies in text format (e.g. OK)
Z	Resetting the modem to the supply state
~ (Tilde)	Causes the modem to pause for half a second. It is possible to set several ~ in a row. Example "~~~~" causes the modem to pause for 2 seconds
<b>&amp;C0</b>	CD (Carrier Detect) is always on
<b>&amp;C1</b>	Modem controls CD. Required for OZW771
<b>&amp;D0</b>	Ignore DTR (Data Terminal Ready)
D1	Online command mode
<b>D2</b>	If DTR is set to zero, the modem will abort the connection. Required for OZW771
F	Loading the supply state

Commands in bold letters are mandatory for operation with the OZW771.

## Typical AT command sequences

<i>Modem command</i>	<i>Purpose and time of command</i>	<i>Entry on the central communication unit</i>
Reset command	Resetting the modem: <ul style="list-style-type: none"> <li>• At midnight</li> <li>• When RS-232 selector S1 is set to "Modem"</li> <li>• When modem reset button is pressed</li> <li>• Before each message</li> <li>• When turning power on</li> </ul>	ATZ^M
Initialization command	Initialization of modem: <ul style="list-style-type: none"> <li>• At midnight</li> <li>• When RS-232 selector S1 is set to "Modem"</li> <li>• When modem reset button is pressed</li> <li>• Before each message</li> <li>• When turning power on</li> </ul>	ATE0V0L1&C1&D2DS0=2^M
Command opening connection	Calling: <ul style="list-style-type: none"> <li>• Before each message</li> </ul>	ATDP0041417245120^M
Command abortion connection	Hanging up: <ul style="list-style-type: none"> <li>• After message has been delivered</li> <li>• Without feedback from telephone provider within: <ul style="list-style-type: none"> <li>min. 10 s</li> <li>nominal 60 s</li> <li>max. 180 s</li> </ul> </li> </ul>	+++~--ATH0~--^M

## 4.4 Device list

### 4.4.1 General information about the device list

On the device list, a process image of devices and fault status information of devices monitored by the central communication unit is generated.





Generation of the device list is initialized and triggered in the ACS menu tree Commissioning > Device list > Create device list.















Please note the following:

- The central communication unit itself does not appear on the device list
- A fault status message received by a Synco™ device is passed on only if the relevant device is entered on the device list of the central communication unit
- The device search run is made on the line on which the central communication unit is installed
- If the number of Konnex devices installed exceeds the number permitted by the central communication unit, the device list must be entered manually (for details, refer to subsection 4.4.4 "Editing the device list")

### 4.4.2 Generating the device list

## Datapoints

<i>Datapoint</i>	<i>Explanation, example</i>		
Create device list	This function must be performed only if: <ul style="list-style-type: none"> <li>• The device list has not yet been created locally</li> <li>• Other devices have been connected</li> <li>• The device addresses on Konnex devices have been changed</li> </ul>		

<i>Datapoint</i>	<i>Explanation, example</i>		
	<ul style="list-style-type: none"> <li>The central communication unit or the devices were assigned to some other line</li> </ul> To generate the device list, enter Yes. Prior to generating the device list, the central communication unit performs function Identify device address automatically (refer to subsection 4.3.1 "Konnex"). When the device list has been generated, the device information will automatically be updated. Then, the ACS Popcard and all other applications must be <b>closed</b> and command <code>Plant &gt; Update device list</code> must be chosen on the ACS main menu. Only then does the ACS register the final address of the central communication unit. During the time the function is performed, ACS can no longer update the datapoints.		
Update device information	The device information of all devices will be updated on the device list. During the time the function is performed, ACS can no longer update the datapoints.		–
Number of devices current	The number of active Konnex devices on the device list will be displayed.		
Number of devices maximum	The maximum possible number of Konnex devices on the device list will be displayed (depending on the type of central communication unit)		
Device 1	The state (active / inactive) will be displayed for each device. Active / inactive means: The device will be monitored / not monitored. When entering the device list manually, "free entries" on the device list can be preselected here, or devices can be removed from the device list. This setting is in accordance with the user's preselection whether or not a device shall appear on the device list and thus in the menu tree. If a device is set to Inactive, the network address on the device list will be reset to (0.0.0).		–
Device 2			–
Device 3			–
Device 4			–
Device 5			–
Device 6			–
etc.			–

### Creating the device list

Datapoint Create device list = Yes starts the device search run. This enables the central communication unit to create or extend its device list. Indication is made with the operation LED (item 5 in the illustration in section 2.2 "Operating elements of the central communication unit"). The operation LED remains dark during the time the device list is created; it flashes briefly 3 times when the list is completed.

### Sequence of creation

If, after the functional start, the device address of the central communication unit is still the same as that supplied, the central communication unit performs function Identify device address automatically (refer to subsection 4.3.2 "Clock function"). Then, the central communication unit queries all Konnex bus users together; each of them gives the following replies:

- Network address (area, line and device address)
- Serial number
- Information required to load the correct ACS device description in ACS

The device search run only identifies Synco™ devices that give correct responses. Third-party devices including line couplers do not respond.

The device list is created based on the responses given by the users. On completion of the device search run, all device information will be updated (for details, refer to subsection 4.4.3 “Updating device information”).

#### Order on the device list

- If the central communication unit does not yet contain a device list, it will be created in the order the replies are given
- If the central communication unit already contains a device list, the replies will be compared with the device addresses of the existing entries and, if there is agreement, they will be overwritten. If there is no agreement, the device will be newly added to the device list. New devices will first be inserted in the “gaps” (devices having the Not checked state) and only then be added at the end, if space is still available.

#### Triggering the device search run

The device search run can be triggered via a datapoint, or locally on the central communication unit.

The device search run is active for:

- A minimum of 15 seconds
- A maximum of 5 seconds after the last reply to the query is received. The point in time the last reply is received is dependent on the current bus load

The central communication unit indicates the end of the device search run only when all other data have been queried also. Then, the operation LED flashes quickly 3 times. During the time a device search run is performed, repeated activation of Create device list has no effect; the command will be ignored.

### 4.4.3 Updating device information

---

Datapoint Update device information in Commissioning > Device list adapts the data of all devices on the device list of the central communication unit.

A device that is contained on the device list but that does not respond to the central communication unit's query remains entered and its device state will be marked as Not present. In that case, fault status message 5011 (Commissioning: Device not found) will be delivered. This fault can be rectified by checking the relevant device and then activating datapoint Update device information.

This function can be used after a faulty device has been replaced and the new device has been commissioned, for example.

### 4.4.4 Editing the device list

---

The device list can be edited via the ACS Popcard. The following choices are available:

- Adding devices:  
This is made by setting the relevant device to Active and by entering its address manually
- Removing devices:  
This is made by setting the relevant device to Inactive

Reasons for editing the device list manually can be the following:

- The number of devices connected within a line exceeds the number of spaces available on the device list (e.g. after a plant extension in case a second central communication unit is required)
- The enduser wants to structure his plant (e.g. devices 10...18 are located in building 1; devices 20...26 in building 2, devices 30...34 in building 3, etc.)
- A device is connected to a line other than the OZW771
- Due to current Konnex bus overload, a device could not be found

#### Adding a device

On the device list, there are still inactive device storage spaces available. By activating a Device... datapoint, the space on the device list will be preselected for the new device.

This does not mean however that the device is completely contained on the device list. Its device state is Not checked. The device address must be manually entered on the ACS Popcard of the activated device (refer to subsection 4.4.5 “ Device 1, device 2, etc.”) and the device information must be updated.

During the updating process, the device will be checked and – if present – the device state will change to Present. Then, the device information, device name, device type, fault information and fault text will be updated.

If the check is negative (device not identified), the device state will change to Not present.

### Removing a device

To delete a device via the Popcard, it must be deactivated. This is made by setting its datapoint on the device list to Inactive. As a result, the device state changes to Not checked and the remaining fields will be set to their initial state.



### Note



In any case, it is recommended to generate the device list with the help of the device search run. If the number of Synco™ devices exceeds the maximum number of devices that can be connected (4, 10 or 64, depending on the type of central communication unit), the device list must subsequently be edited.

## 4.4.5 Device 1, device 2, etc.

For each device on the device list, information can be retrieved and partly edited. If the device list shall be generated manually, the network addresses of the Synco™ devices to be read in and administered must be entered here. By making the entry manually, the entry on the device list will be adapted to the new device address.

### Datapoints

<i>Datapoint</i>	<i>Explanation, example</i>		
<b>Network address</b>			
Area	Here, the area of the network address of the device to be monitored must be entered. It can be selected between 0 and 15	<input checked="" type="radio"/>	<input type="radio"/>
Line	Here, the line of the network address of the device to be monitored must be entered. It can be selected between 0 and 15	<input checked="" type="radio"/>	<input type="radio"/>
Device address	Here, the device address of the network address of the device to be monitored must be entered. It can be selected between 1 and 254	<input checked="" type="radio"/>	<input type="radio"/>
<b>Device information</b>			
Update device information	Entry Yes updates the following device information of the respective device. This function must <b>always</b> be performed after a change of line or area setting, or device address	<input checked="" type="radio"/>	<input type="radio"/>
Device name	The name is to be entered on the Konnex device	<input type="radio"/>	<input type="radio"/>
Device state	The current states are shown in the illustration on page 31	<input type="radio"/>	<input type="radio"/>
Device type	Indication of type reference. Example: QAW740 (Synco™ room unit)	<input type="radio"/>	<input type="radio"/>

<i>Datapoint</i>	<i>Explanation, example</i>		
Fault information	This information includes the date, the time of day the fault occurred, and the Synco™ fault number. Example: 24.08.2004; 15:14; 5001	<input type="radio"/>	<input type="radio"/>
Fault text	This is the Synco™ fault text; it is assigned to the Synco™ fault number. Example 5001 = System time failure The central communication unit reads the fault text based on the reported fault number from the relevant device. For this reason, the text is dependent on the text selection of that device	<input type="radio"/>	<input type="radio"/>

These datapoints repeat themselves for each Synco™ device connected to Konnex. After making changes to the device list, the ACS Popcard and all other applications must be closed and command **Plant > Update device list** on the ACS main menu must be chosen.

### Device list state

On the device list, each device connected to the Konnex bus is identified by the Device state. ACS uses this state in the menu tree representation.

The following states are defined:

<i>State</i>	<i>Description</i>
Not checked	The entry on the device list is inactive or the device information has not yet been updated after the Active setting
Checking	Temporary state during the time the device is checked
Present	The device is available on Konnex and communicates with the central communication unit
Not present	The device is not available or is not a Synco device

### Available choices

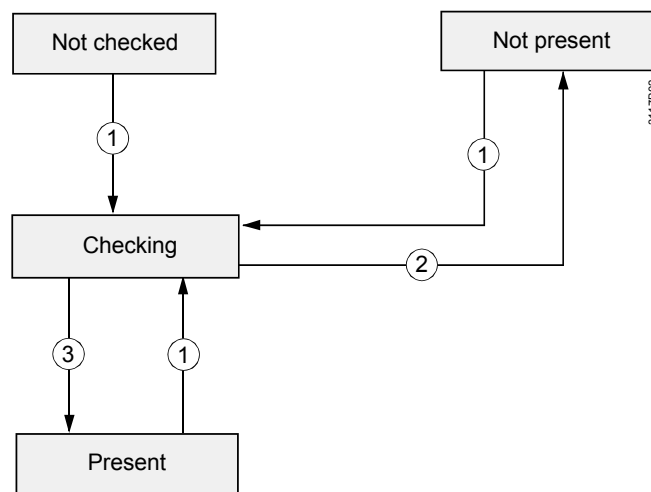

<i>Action</i>	<i>Procedure</i>	<i>Fault status message</i>
1	Update device information	
2	Device does not respond	5011 "Commissioning: Device not found"
3	Device responds	

For a detailed description of failure supervision of devices and of the impact device states have on faults, refer to subsection 6.7.4  "Device 1, device 2, etc.".

## 4.5 Message receivers

### 4.5.1 Fundamentals

The central communication unit supports all types of message receivers:





- PC with ACS Alarm
- SMS receivers
- Pager
- Fax
- E-mail

For the transmission of messages to the different types of receivers, the central communication unit uses different types of transmission protocols, which are not supported by all telephone providers. For this reason, providers for all types of protocols cannot be found in all countries. For more information, contact your closest telephone provider or the closest Siemens Building Technologies sales office.

### 4.5.2 Modem connection

#### Datapoints

If the connection to the message receivers are made via modems, they need to be configured.

<i>Datapoint</i>	<i>Explanation, example</i>		
Modem message interval	The interval can be set in the range between 2 and 30 minutes. Refer to "Modem message interval" below		–
Modem message repetition	The number of repetitions can be set: None, 1, 2, 3, unlimited. Refer to "Modem message repetition" below		–
Position message selector	Messages are delivered by the central communication unit only if message switch S2 is set to "On" (item 1 in the illustration in section 2.2 "Operating elements of the central communication unit"). The position of message selector S2 can be read		–

Modem message interval

The message interval ensures that the central communication unit can be contacted between 2 message stops. It can be set in the range between 2 and 30 minutes. For detailed information, refer to subsection 6.8.2 "Modem connection".

Modem message repetition

A maximum number of dial repetitions can be defined for each message receiver and each message. This reduces phone costs if the partner station is not ready for opening the connection and receiving the message. For detailed information, refer to subsection 6.8.2 "Modem connection".

### 4.5.3 Receiver type

#### Fundamentals

If the receiver type is the ACS, the central communication unit will send the message directly to the receiver's phone number. If the receiver type is a mobile phone, pager, fax or e-mail, the central communication unit sends the message to the telephone provider which will then pass it on to the message receiver.

The protocol to be used for transmitting the message must be selected on the central communication unit, independent of the selected telephone provider and modem.

To make certain the telephone provider knows where the message is to be sent, the central communication unit passes appropriate information to the telephone provider. Depending on the type of modem selected (refer to subsection 4.3.3  Modem"), messages can be sent to the following receiver types:



Receiver type	Type of modem		
	Analog	GSM	ISDN
ACS*	•	•	•
SMS (GSM)	–	•	–
SMS (UCP)	•**	•**	•**
SMS (TAP)	•**	•**	•**
Fax (GSM)	–	•**	–
E-Mail (GSM)	–	•**	–
Pager (GSM)	–	•**	–
Pager (TAP)	•**	•**	•**

\* With ACS7... versions 4.0 and 4.01: "PC"





\*\* Depending on the telephone provider

## Notes

There is a large number of different receiver types available to make certain that – in addition to ACS – at least one more receiver type can be addressed in each country.

## Datapoints

Separate settings can be made for message receiver 1 and message receiver 2. The explanations given also apply analogously to message receiver 2.

Datapoint	Explanation, example		
Receiver type	<p>The following types of receivers can be used:</p> <ul style="list-style-type: none"> <li>• ACS*</li> <li>• SMS GSM</li> <li>• SMS UCP</li> <li>• SMS TAP</li> <li>• Fax GSM</li> <li>• E-Mail GSM</li> <li>• Pager GSM</li> <li>• Pager TAP</li> </ul> <p>The receiver types shown are only those that can be used after selecting the type of modem (refer to subsection 4.3.3 " Modem")</p>		

\* With ACS7... versions 4.0 and 4.01: "PC"

## Handling special characters

Special characters are filtered when entering the phone number. To avoid incorrect parameterization, only the following characters will be accepted with numerical values (phone numbers and codes):

Character	Usual meaning of modem command
Digits 0...9	
, (comma)	Delay 0...8 s (default setting = 2 s)
w	Waiting until exchange line is available
=	Delay 3 s
<	Delay 1 s
+	International area code with GSM

Other characters will be ignored. To improve readability, phone numbers can include blanks, slashes, etc. Depending on the receiver type, these are filtered as follows, if required:

Phone number	Receiver type	Filtering is ensured by:
Receiver's phone number	ACS*	Modem
Receiver's phone number	All except ACS*	Central communication unit
Service provider's phone number	All	Modem

\* With ACS7... versions 4.0 and 4.01: "PC"

For example, entry 041/724 35 62 will be accepted as 04117243562.

Phone number of provider with GSM modem read from SIM card

Preliminary remarks:

- With a GSM modem, the telephone provider's phone number stored on the SIM card will be adopted. It is not possible to use the phone number of some other telephone provider
- RS-232 selector S1 must be set to "Modem"
- When selecting a GSM protocol (Commissioning > Message receiver > Receiver type) "+" is written in datapoint Commissioning > Message receiver > Phone number provider

If this "+" in ACS is deleted, the GSM modem will read the GSM provider number from the SIM card to write it to datapoint Phone number provider.

For safety reasons, the SMS provider number continues to be dialable for all types of receivers; normally, however, the number should be adopted from the SIM card.

In normal plant operation, each time an SMS is sent, the central communication unit overwrites the provider number of the SIM card when making the entry in datapoint Phone number provider. This offers the opportunity to add a missing provider number to the SIM card.

Caution

Function "Read phone number provider with GSM modem from SIM card" can only be performed 60 seconds after starting the central communication unit (e.g. fresh start after a power failure). The GSM modem must be connected.

Procedure:

1. For datapoint Commissioning > Modem > Modem type, select: GSM
2. For datapoint Commissioning > Message receiver > Receiver type, select: ... GSM
3. Datapoint Phone number provider: Delete entry
4. The provider number is read from the SIM card and written to the datapoint.

If not:

Readjust datapoint Baud rate RS-232 in steps and repeat step 4 until the provider number is read out. Each time the Baud rate is readjusted, wait about 10 seconds.

Caution

The provider number on the SIM card will be overwritten when sending an SMS, independent of the entry made in datapoint Phone number provider. If messages shall be sent to a receiver type SMS GSM, all information from section "Receiver type = SMS" and section "Communication protocol GSM" is decisive.

During the time message selector S2 is in the "Off" position, the sending of SMS will be suppressed and thus overwriting of the provider number also (exception: Pressing on the modem reset button for 6 seconds).

**Dependency of receiver data**

Depending on the type of receiver, the following types of communication protocols are supported:

Communication protocol	Type of message receiver				
	ACS*	SMS	Fax	E-mail	Pager
ACS	•				
GSM		•	•	•	•
UCP		•			
TAP		•			•

\* With ACS7... versions 4.0 and 4.01: "PC"

The receiver data are dependent on:



- The communication protocol **and**
- The type of message receiver

In the following, all types of communication protocols and message receivers are covered. With receiver type ACS, communication protocol and message receiver are identical.

Example

If a message shall be sent to a receiver type SMS GSM, all information given in paragraphs "Message receiver type = SMS" and "Communication protocol = GMS) applies.



### Communication protocol and message receiver type = ACS\*

<i>Datapoint</i>	<i>Explanation, example</i>		
Phone number receiver	<ul style="list-style-type: none"> <li>In modem operation, the phone number to be dialed is the phone number of the modem to which the PC with ACS is connected. For international calls, the area code is <b>00</b> Example: 0041...</li> <li>In direct operation, no phone number is required</li> </ul>	<input checked="" type="radio"/>	<input type="radio"/>



\* With ACS7... versions 4.0 and 4.01: "PC"

ACS in modem operation is the only setting with which several fault status messages can be delivered in consecutive order, with no intermediate abortion of the connection and new dialing.

### Communication protocol = GSM

<i>Datapoint</i>	<i>Explanation, example</i>		
Phone number provider	This number should always be read from the SIM card of the GSM modem: Refer to section "Read phone number provider with GSM modem from SIM card". The only number that can be used is the business number of the provider which supplied the SIM card in the GSM modem. International calls must be started with "+". Example: +41787777070	<input checked="" type="radio"/>	<input type="radio"/>
Phone number receiver	For international calls, the area code is 00. Example: 0041...	<input checked="" type="radio"/>	<input type="radio"/>



### Communication protocol = UCP

<i>Datapoint</i>	<i>Explanation, example</i>		
Phone number provider	For international calls, the area code is <b>00</b> . Example: 0041794998990	<input checked="" type="radio"/>	<input type="radio"/>
Phone number receiver	For international calls, the area code is <b>00</b> . Example: 0041...	<input checked="" type="radio"/>	<input type="radio"/>



Note

With the UCP protocol, the central communication unit operates with the definition "Call Input Operation" = 51.

### Communication protocol = UCP via GSM network

<i>Datapoint</i>	<i>Explanation, example</i>		
Phone number provider	For international calls, the area code is <b>00</b> . Example: 0041794998990	<input checked="" type="radio"/>	<input type="radio"/>
Phone number receiver	For international calls, the area code is <b>00</b> . Example: 0041...	<input checked="" type="radio"/>	<input type="radio"/>

### Communication protocol = TAP



<i>Datapoint</i>	<i>Explanation, example</i>		
Phone number provider	For international calls, the area code is <b>00</b> . Example: 0041900103033	<input checked="" type="radio"/>	<input type="radio"/>
Phone number receiver	2860612 (RIC number)	<input checked="" type="radio"/>	<input type="radio"/>
Hardware settings	8N1 or 7E1 (as supplied), depending on the telephone provider. Meaning: (for 8N1) 8 = number of data bits N = parity (N = non, E = even) 1 = number of stop bits	<input checked="" type="radio"/>	<input type="radio"/>

### Receiver type = SMS

With SMS telegrams, the message is considered delivered as soon as there is a positive reply from the provider. Only 1 SMS at a time can be delivered per connection. Delivery of several SMS per connection is dependent on the provider and, for this reason, not supported by us.



### Receiver type = fax

Directing messages and system reports to a fax machine with OZW771 is only possible via the GSM network and necessitates a GSM modem. The telephone provider must support GSM connections and the required redirecting function.

<i>Datapoint</i>	<i>Explanation, example</i>		
Prefix	*fax#		-



### Receiver type = e-mail

Directing messages and system reports via e-mail with OZW771 is only possible via the GSM network and necessitates a GSM modem. The telephone provider must support GSM connections and the required redirecting function.

<i>Datapoint</i>	<i>Explanation, example</i>		
Prefix	With the prefix, the telephone provider's e-mail address must be entered; make certain an * is used in place of the @: Correct: name*provider.com Wrong: name@provider.com		-

### Receiver type = pager

With pager telegrams, the message is considered delivered as soon as there is a positive reply from the provider. Only 1 pager message at a time can be delivered per connection buildup. Delivery of several pager messages per connection is dependent on the provider and, for this reason, not supported by us.

<i>Datapoint</i>	<i>Explanation, example</i>		
Display format	For information, refer to the following section		-

For historical reasons, messages on pagers use the following display formats:

- 20 characters, numeric: Only numbers are sent
- 40 characters, alphanumeric: Text with a maximum length of 40 characters is sent
- 80 characters, alphanumeric: Text with a maximum length of 80 characters is sent
- 160 characters or more, alphanumeric: Text with a maximum length of 160 characters is sent

On the central communication unit, the display format must be selected because if, for example, 80 alphanumeric characters are sent to a 20- or 40-character pager, the receiver often shows no message. The central communication unit automatically limits the total length of the message to the maximum of the selected value.

Numeric

Serves for the transmission of pure numbers, such as phone numbers, fault numbers, etc. The central communication unit ensures that the message only contains numbers. In the case of phone numbers, this does not take place automatically. For this reason, when setting the parameters of the central communication unit, it must be made certain that only numbers are used for phone numbers.

Alphanumeric

Serves for the transmission of text, such as fault status messages, designations, etc. The messages must not contain any special characters or vowels. The characters permitted are the following:

- a...z and A...Z
- 0...9
- Blanks ! „ \$ % & , ( ) \* + ` - . / : ; < = > ?

When sending messages, invalid characters are converted to ? (question marks).

Pager with 20 characters

The Phone number plant must not comprise more than 15 numbers to ensure that the fault number will not be cut off.

Pager with 40 characters

For datapoints Plant name and Phone number plant, a **total** of 34 characters is permitted.

## 4.6 Faults

The central communication unit differentiates between 3 types of faults:

- Faults with signals delivered to the central communication unit's fault input
- Internal faults
- Faults with signals delivered to the central communication unit via Konnex bus

The fault status messages are passed on to the parameterized message receiver. The most urgent of all faults (internal faults and faults at the fault inputs) is sent to the Konnex bus users (for display).

### 4.6.1 Fault inputs

#### General

The central communication unit has 2 fault inputs for the connection of potential-free contacts. The normal position of the contacts (fault / no fault) and the fault priority can be parameterized.

#### Typical input signals















Typical input signals at the fault inputs are the following:





- Common messages from external plant (e.g. burner lockout)
- Fault signals from pumps
- Thermal switches
- Level switches (e.g. oil level)

#### Parameter settings

Parameters are set via the ACS menu: **Applications > Popcard**, menu tree: Commissioning > Faults.

#### Datapoints

<i>Datapoint</i>	<i>Explanation, example</i>		
Fault input 1	A contact of an external device (e.g. thermostat) connected to the fault input opens or closes, thereby signaling fault / no fault. For more information, refer to subsection 6.7.1 "Fault inputs"		
Normal position	The normal position of the contact (open / closed) at the fault input must be entered; the opposite state will generate a fault status message		
Text fault input 1	A user-defined text can be entered describing the plant component monitored by the contact (e.g. fuel oil level). A maximum of 20 characters are available		
Text for: No fault*	For the No fault state, a user-defined text can be entered. Example: "Normal" for the fuel oil level. A maximum of 20 characters are available		
Text for: Fault*	For the Fault state, a user-defined text can be entered. Example: "Too low" for the fuel oil level. A maximum of 20 characters are available		
Fault priority	The priority can be selected***: Nonurgent or Urgent		

<i>Datapoint</i>	<i>Explanation, example</i>		
Message receiver	No messages** No messages are delivered to the message receivers		
	1 Messages are delivered to message receiver 1		
	2 Messages are delivered to message receiver 2		
	1 + 2 Messages are delivered to message receivers 1 and 2		
Message triggering	If messages are delivered to message receivers, message triggering need to be parameterized: <ul style="list-style-type: none"> <li>Coming: Fault is signaled when it occurs</li> <li>Coming and Going: Fault is signaled when it occurs and when it disappears</li> </ul>		–

\* With ACS7... versions 4.0 and 4.01: "No fault" or "Fault"

\*\* With ACS7... versions 4.0 and 4.01: "Alarming off"

\*\*\* The central communication unit only sends the most urgent fault signal to the Konnex bus

For fault input 2, the same settings apply analogously as for fault input 1.

### Selecting another language

If another language is selected (Commissioning > Central communication unit > Language), the user-defined texts will be replaced by the default texts of the selected language.

### Fault as a message

The following examples "Oil level" and "Water filter" show that a fault input can be used not only for generating fault status messages but also for other messages.

<i>Fault input</i>	<i>Normal position</i>	<i>Text fault input</i>	<i>Text for: Fault*</i>	<i>Text for: No fault*</i>
1	Closed	Oil level	Low	o.k.
2	Open	Water filter	Maintenance due	o.k.

\* With ACS7... versions 4.0 and 4.01: "No fault" or "Fault"

### Wiring test

To check wiring, the aggregates connected to the fault inputs can be manually controlled in order to simulate faults. The red fault LED must **flash**.

### Indication

For a description of the display of faults of fault inputs, refer to subsection 6.7.1 "Fault inputs".

## 4.6.2 Central communication unit





### Brief description



The central communication unit monitors itself and detects internal faults. Parameterization of the central communication unit's internal faults includes both the message receiver and message triggering (message when occurring and disappearing or when occurring only).

These parameters are to be set on menu: **Applications > Popcard**, menu tree: Commissioning > Faults.

### Central communication unit

Here, it is specified how the fault status messages that the central communication unit detects in itself shall be handled.

<i>Datapoint</i>	<i>Explanation, example</i>		
Message receiver	No messages* No messages are delivered to the message receivers		
	1 Messages are delivered to message receiver 1		
	2 Messages are delivered to message receiver 2		
	1 + 2 Messages are delivered to message receivers 1 and 2		

<i>Datapoint</i>	<i>Explanation, example</i>		
Message triggering	If messages are delivered to message receivers, message triggering must be parameterized: <ul style="list-style-type: none"> <li>Coming: Fault is signaled when it occurs</li> <li>Coming and Going: Fault is signaled when it occurs and when it disappears</li> </ul>		–

\* With ACS7... versions 4.0 and 4.01: "Alarming off"

## Interrogation

For a description of the indication of faults of fault inputs, refer to subsection 6.7.2 "Central communication unit".

### 4.6.3 Konnex

#### Brief description





From each Synco™ device connected to the Konnex bus, the central communication unit receives the fault status messages with the highest priority. For the devices entered on the device list for monitoring, the central communication unit displays the relevant messages.

Parameterization of the Synco™ device faults transmitted via Konnex includes the message receiver (phone number of the receivers) and the triggering of messages (message when occurring and disappearing or when occurring only).

This parameterization is made on menu **Applications > Popcard**, menu tree: Commissioning > Faults.

#### Konnex

Here, it is to be specified how fault status messages transmitted to the central communication unit via Konnex shall be handled.

<i>Datapoint</i>	<i>Explanation, example</i>		
Message receiver	No messages* No messages are delivered to the message receivers		
	1 Messages are delivered to message receiver 1		
	2 Messages are delivered to message receiver 2		
	1 + 2 Messages are delivered to message receivers 1 and 2		
Message triggering	If messages are delivered to message receivers, message triggering must be parameterized: <ul style="list-style-type: none"> <li>Coming: Fault is signaled when it occurs</li> <li>Coming and Going: Fault is signaled when it occurs and when it disappears</li> </ul>		–

\* With ACS7... versions 4.0 and 4.01: "Alarming off"





## Interrogation

For a description of indication of faults transmitted via Konnex, refer to subsection 6.7.3 "Konnex".

### 4.7 System report

It is possible to generate a system report, which informs about the current plant state at regular intervals.

The following configurations are required:

<i>Datapoint</i>	<i>Explanation, example</i>		
Message receiver	No messages* No system report is delivered to the message receivers		
	1 System report is delivered to message receiver 1		

<i>Datapoint</i>	<i>Explanation, example</i>		
	2 System report is delivered to message receiver 2		
	1 + 2 System report is delivered to message receivers 1 and 2		
Signal time	If a system report is parameterized at one of the message receivers (1 / 2 / 1+2), the signal time need to be defined. The format is hh:min; the resolution is 1 minute	<input checked="" type="radio"/>	<input type="radio"/>
Message cycle	If a system report is parameterized at one of the message receivers (1 / 2 / 1+2), the message cycle must be defined. It can be selected in the range from 1 to 255 days. The system report is delivered for the first time on completion of the set message cycle	<input checked="" type="radio"/>	<input type="radio"/>

\* With ACS7... versions 4.0 and 4.01: "Alarming off"

Contents and representation of the system report are ready configured. In addition to general information about the plant (plant name, etc.), the system report contains the message OK or N.OK. For more detailed information, refer to subsection 6.3.5 "System report to the ACS".

## 4.8 Text

Here, any Text for individual datapoints can be entered during commissioning or during normal plant operation, e.g. adjustments to local conditions such as language of the plant operator. These texts are used in the SMS telegrams and in the pager messages. For more detailed information, refer to section 6.3 "Representation of messages" and following.

### Datapoints

<i>Datapoint</i>	<i>Explanation, example</i>		
Text for:			
Device	Maximum 20 characters permitted	<input checked="" type="radio"/>	-
Inputs	Maximum 20 characters permitted	<input checked="" type="radio"/>	-
No fault	Maximum 20 characters permitted	<input checked="" type="radio"/>	-
Faults	Maximum 20 characters permitted	<input checked="" type="radio"/>	-
System report	Maximum 20 characters permitted	<input checked="" type="radio"/>	-
Device failure	Maximum 20 characters permitted This text is used with all types of message receivers, except with ACS, to signal device failures: E.g. Device failure 00.02.250. With the ACS message receiver, the fault text from subsection 6.7.2 "Central communication unit" is used: E.g. Device failure. In this case, the address of the faulty device is transferred to some other field of the fault status message.	<input checked="" type="radio"/>	-

### Selecting another language

For these datapoints, the central communication unit contains default texts. If another language is selected (Commissioning > Central communication unit > Language), the user-defined text will be replaced by the default Text of the selected language.



## 4.9 Replacement of central communication unit

---



When replacing a central communication unit, it is recommended to observe the following procedure:

1. Use the ACS to read the parameter set of the central communication unit (ACS menu `Application > Parameter settings...`) and export it.
2. Replace the central communication unit.
3. Import the parameter set and write it to the new communication unit.
4. Update the device information on the central communication unit (refer to subsection 4.4.2 "Generating the device list").
5. Update the device list on ACS menu `Plant > Update device list` .
6. Check the settings of the central communication unit and the device list.

# 5 Completing commissioning

## 5.1 Central communication unit and connections

---

1. If the central communication unit is in addressing mode (programming LED lit), it must now be switched to normal mode.  
To do this, press the Konnex bus button for a short moment (<2 seconds).
2. Set message selector S2 "Alarm" to "On"  (On = messages and system reports delivered to message receivers).
3. Set RS-232 selector S1 to the correct position, if not already done:  
When using the modem connection: Set selector S1 to "Modem" . Refer to subsection 2.1.4 "Communication via the telephone network".  
When using the direct connection: Set selector S1 to "PC" . Refer to subsection 2.1.3 "Communication via RS-232 port".
4. Keep modem reset button depressed for 6 seconds.
5. Now, the central communication unit builds up the connection to the message receivers and sends a system report (a fault during communication buildup is indicated by the red fault LED; it flashes).
6. Check to see if the message receivers have received the system report.

### Important

After commissioning, the connections to the message receivers must be checked to avoid unnecessary service visits due to nonworking modem communication. To make the connection test to ACS, ACS Alarm must be started on the receiving PC.

## 5.2 Wiring the fault inputs

---

To check wiring, the devices connected to the fault inputs of the central communication unit can be manually controlled to simulate faults. The red fault LED must flash and the central communication unit must deliver a fault status message to the message receiver.

## 6 Plant operation

---

### 6.1 Fault indication on the central communication unit

---

Section 2.2 "Operating elements of the central communication unit" gives a description of all choices available on the central communication unit itself.

### 6.2 Faults and messages

#### 6.2.1 Faults on the plant and their messages

---

During plant operation, the collection of faults from the plant and passing them on to the message receivers is the major task of the central communication unit.

Sources of faults and messages:

- The 2 fault inputs of the central communication unit
- The central communication unit itself
- All Synco™ devices on the Konnex bus that are contained on the device list

The central communication unit handles faults (e.g. indication by fault LED, storage) and passes them on as messages to the parameterized message receivers (e.g. ACS or mobile phone).

A detailed description of the relevant parameter settings is given in chapter 4 "Commissioning the central communication unit with ACS7... software".

#### 6.2.2 System report of plant

---

The "System report" function checks the plant at regular intervals and signals periodically its correct functioning or, if necessary, pending faults. The receiver choices are the same as those available with the passing on of faults and messages.

The representation of the system report parameterized for passing on to a mobile phone is ready configured.

### 6.3 Representation of messages

#### 6.3.1 Fault status messages to ACS Alarm

---

##### General

The central communication unit sends the fault status messages and system reports to ACS Alarm.

ACS Alarm uses 3 types of representation for fault status messages:

- Alarm popup
- Main alarm view; all pending alarms are shown
- Detailed alarm view

##### Alarm popup

The alarm popup appears right after an alarm has been received. The most important information about the alarm is displayed for the enduser.

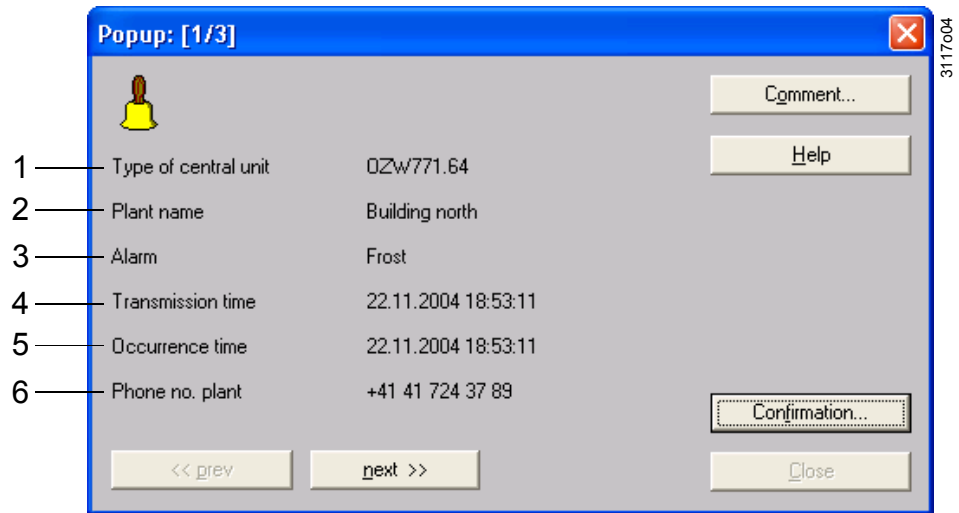

	<i>Explanation, origin of indication, path of relevant entry</i>
1	Indication will automatically be generated***
2	According to entry Commissioning > Central communication unit > Plant name
3	<p>Fault status message at the fault input:</p> <ul style="list-style-type: none"> <li>• According to entry Commissioning &gt; Faults &gt; Text for: Fault*</li> <li><b>or</b></li> <li>• According to entry Commissioning &gt; Faults &gt; Text for: No fault*</li> </ul> <p>Internal OZW771 fault status message:</p> <ul style="list-style-type: none"> <li>• Synco™ fault text (see list in subsection 6.7.2 “Central communication unit”)</li> <li><b>or</b></li> <li>• No fault (Commissioning &gt; Texts &gt; Text for... No fault)</li> </ul> <p>Fault status message on Konnex bus**:</p> <ul style="list-style-type: none"> <li>• Synco™ fault text (see list in the of the respective device), or</li> <li>• User-defined text for the relevant fault of the respective device (entry on that device), or</li> <li>• Device failure (detected by the central communication unit; Commissioning &gt; Texts &gt; Text for... Device failure)</li> <li><b>or</b></li> <li>• No fault (Commissioning &gt; Texts &gt; Text for... No fault)</li> </ul>
4	Display is automatically generated by the central communication unit
5	Display is automatically generated by the fault source
6	According to entry Commissioning > Central communication unit > Phone number plant

\* With ACS7... versions 4.0 and 4.01: “Fault” or “No fault”

\*\* Depending on the language of the respective device

\*\*\* According to Commissioning > Central communication unit > Type

## Main alarm view

The main alarm view is the default view of ACS Alarm.

Plant name	Alarm	Occurrence time	Device error	Transmission time	Phone no. plant	Type of central unit
Zone North	Zone North (0.2.253)	26.11.2004 12:52:21	No bus power supply	26.11.2004 12:52:22	041 724 9876	OZW771.64
Zone North	Aux 2 (Input 2) (0.2.253)	26.11.2004 12:52:03	Fault	26.11.2004 12:52:03	041 724 9876	OZW771.64
Zone North	Device 1 (Device 1) (0.0.101)	26.11.2004 12:50:00	Aux 1	26.11.2004 12:50:33	041 724 9876	OZW771.64
Zone North	Device 1 (Device 1) (0.0.101)	26.11.2004 12:49:00	OT sensor	26.11.2004 12:49:45	041 724 9876	OZW771.64
Zone North	Aux 1 (Input 1) (0.2.253)	26.11.2004 12:49:17	Fault	26.11.2004 12:49:18	041 724 9876	OZW771.64

②                      ⑦                      ⑤                      ③                      ④                      ⑥                      ①

Press F1 for help                      1 - 5 / 5

	<i>Explanation, origin of display, path of the relevant entry</i>
1...6	Like alarm popup in the previous section
7	<p>Fault status message at the fault input:</p> <ul style="list-style-type: none"> <li>• According to entry Commissioning &gt; Faults &gt; Fault input 1 (or 2)</li> <li>• According to entry Commissioning &gt; Texts &gt; Text for... Input</li> <li>• Number of input (will be generated automatically)</li> <li>• Network address (will be generated automatically)</li> </ul> <p>OZW771 internal fault status message:</p> <ul style="list-style-type: none"> <li>• According to entry Commissioning &gt; Central communication unit &gt; Plant name</li> <li>• Network address (will be generated automatically)</li> </ul> <p>Fault status message on Konnex bus:</p> <ul style="list-style-type: none"> <li>• Device name (entered on this device)*</li> <li>• According to entry Commissioning &gt; Texts &gt; Text for... Device</li> <li>• Network address (will be generated automatically)</li> </ul>

\* If not entered: User-defined text for "device" and device number according to the device list, according to Commissioning > Texts > Text for device

**Detailed alarm view**

By clicking on one of the alarm lines in the main view, all transmitted alarm data of this alarm will be displayed. The detailed alarm view includes:

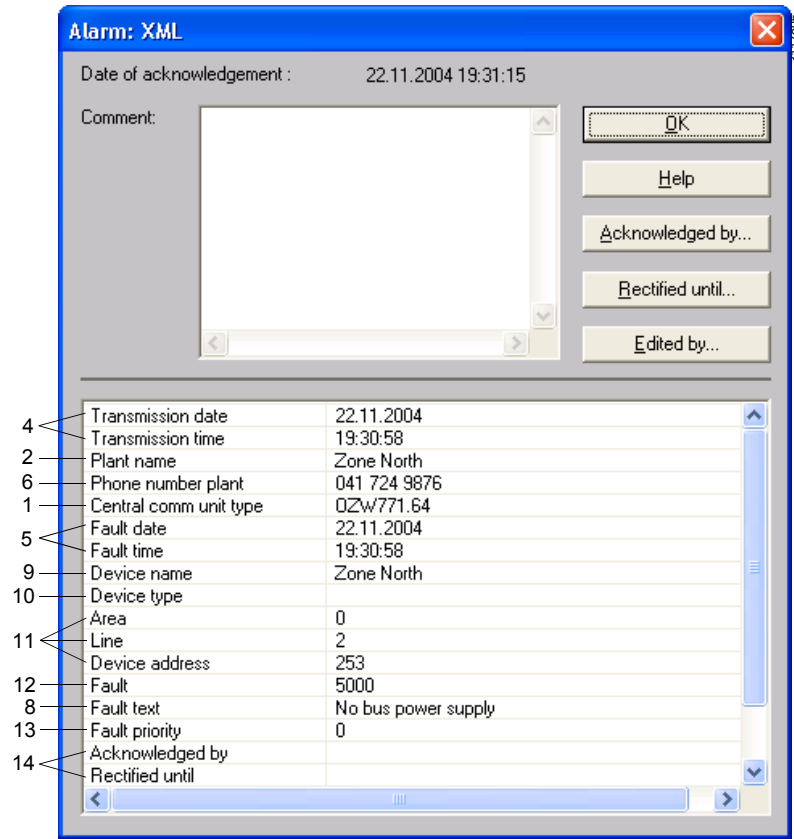

	<i>Explanation, origin of display, path of the relevant entry</i>
1...8	Like alarm popup and main alarm view in the preceding sections
9	Device name will be entered on the Konnex device
10	Automatic generation (the respective device sends its type reference)
11	Network address, will automatically be generated
12	Synco™ fault number, will automatically be generated
13	With fault inputs according to entry Commissioning > Faults > Fault priority, otherwise automatically
14	ACS internal fields for alarm administration

**6.3.2 Fault status messages to mobile phone (SMS)**

The display of fault status messages parameterized to be passed on to a mobile phone is ready configured.

In the central communication unit, the fields of the SMS message are separated by blanks.

The provider's phone number (including that of the SMS receiver) is to be entered in datapoint Commissioning > Message receiver > Phone number provider.

**Message at the central communication unit's fault input**

	<i>Datapoint, information</i>	<i>Path in ACS menu tree</i>	<i>Example</i>
1*	Occurrence time	–	19.03.2004 09:55:21
2	Plant name	Commissioning > Central communication unit > Plant name	School building East
3	Phone number plant	Commissioning > Central communication unit > Phone number plant	0129876543

	<i>Datapoint, information</i>	<i>Path in ACS menu tree</i>	<i>Example</i>
4	User-defined text for the fault input <b>and</b> user-defined text for the input <b>and</b> the number of fault input 1 or 2	Commissioning > Faults > Text fault input 1 ( <b>or</b> 2)	Burner  (Input 1)
5	User-defined text for fault	Commissioning > Faults > Text for: Fault**	Faults
	User-defined text for no fault	Commissioning > Faults > Text for: No fault**	No fault

\* Depending on the modem's SIM card setting, additional information that is not delivered by the central unit can be inserted as the first line:

- No information (suppression of own phone number is dependent on the modem's SIM card settings)
- Name from the mobile phone's dialing list
- Phone number (plant phone number not contained on the mobile phone's dialing list)

\*\* With ACS7... versions 4.0 and 4.01: "Fault" or "No fault"

### OZW771 internal fault status message

	<i>Datapoint, information</i>	<i>Path in ACS menu tree</i>	<i>Example</i>
1*	Occurrence time	–	19.03.2004 09:55:21
2	Plant name	Commissioning > Central communication unit > Plant name	School building East
3	Phone number plant	Commissioning > Central communication unit > Phone number plant	0129876543
4	Type of central communication unit**	Commissioning > Central communication unit > Type	OZW771.10
5	Synco™ fault text***		>1 clock time master
	User-defined text for no fault	Commissioning > Texts > Text for... No fault	No fault

\* Depending on the modem's SIM card setting, additional information that is not delivered by the central unit can be inserted as the first line:

- No information (suppression of own phone number is dependent on the modem's SIM card settings)
- Name from the mobile phone's dialing list
- Phone number (plant phone number not contained on the mobile phone's dialing list)

\*\* Automatic generation according to the path

\*\*\* According to Synco™ fault number list (refer to the of the relevant device)

### Device fault (fault at the fault input of a Synco™ device)

	<i>Datapoint, information</i>	<i>Path in ACS menu tree</i>	<i>Example</i>
1*	Occurrence time	–	19.03.2004 09:55:21
2	Plant name	Commissioning > Central communication unit > Plant name	School building East
3	Phone number plant	Commissioning > Central communication unit > Phone number plant	0129876543
4	Name of Synco™ device* <b>and</b> user-defined text for the device <b>and</b> device number according to the device list	Setting on the relevant device	Zone South
		Commissioning > Texts > Text for... Device	( Device 5)
5	User-defined text for the relevant fault of the respective device**	E.g. with the RMU720 universal controller: Settings > Faults > Fault input 1 > Fault input 1	Aux 1
	User-defined text for no fault	Commissioning > Texts > Text for... No fault	No fault

\* Depending on the modem's SIM card setting, additional information that is not delivered by the central unit can be inserted as the first line:

- No information (suppression of own phone number is dependent on the modem's SIM card settings)
- Name from the mobile phone's dialing list
- Phone number (plant phone number not contained on the mobile phone's dialing list)

\*\* To be entered on the respective Synco™ device; path dependent on the device type

**Device fault (internal fault of a Synco™ device)**

	<i>Datapoint, information</i>	<i>Path in ACS menu tree</i>	<i>Example</i>
1*	Occurrence time	–	19.03.2004 09:55:21
2	Plant name	Commissioning > Central communication unit > Plant name	School building East
3	Phone number plant	Commissioning > Central communication unit > Phone number plant	0129876543
4	Name of Synco™ device** and user-defined text for the device and the device number according to the device list	Setting on the relevant device  Commissioning > Texts > Text for... Device	Zone South  (Device 5)
5	Synco™ fault text***		>1 clock time master
	Device failure****	Commissioning > Texts > Text for... Device failure	Dev fail
	No fault	Commissioning > Texts > Text for... No fault	No fault

- \* Depending on the modem's SIM card setting, additional information that is not delivered by the central unit can be inserted as the first line:
- No information (suppression of own phone number is dependent on the modem's SIM card settings)
  - Name from the mobile phone's dialing list
  - Phone number (plant phone number not contained on the mobile phone's dialing list)
- \*\* To be entered on the respective Synco™ device; path dependent on the device type
- \*\*\* Depending on the language of the relevant device
- \*\*\*\* Device failure will be detected by OZW771

### 6.3.3 Fault status messages to pager

The display of fault status messages parameterized to be forwarded to a pager is ready configured.

The number of character fields and the maximum number of characters per field are dependent on the pager's format. There is a blank between 2 fields.

For more detailed information, refer to subsection 4.5.3 "Receiver type", paragraph "Receiver type = pager".

**Pager message with 20 characters**

<i>Field</i>	<i>Datapoint, information</i>	<i>Path in ACS menu tree</i>	<i>Example</i>
1	Phone number plant	Commissioning > Central communication unit > Phone number plant	0129876543
2	4-digit Synco™ fault number*		9001
	0000 (= no fault)		0000

- \* According to the Synco™ fault code list (refer to the relevant device)

**Pager message with 40 characters**

<i>Field</i>	<i>Datapoint, information</i>	<i>Path in ACS menu tree</i>	<i>Example</i>
1	Plant name	Commissioning > Central communication unit > Plant name	School building East
2	Phone number plant	Commissioning > Central communication unit > Phone number plant	0129876543
3	4-digit Synco™ fault number*		9001
	0000 (= no fault)		0000

- \* According to the Synco™ fault code list (refer to the relevant device)



**Pager message with 80 characters**

Message at OZW771 fault input

Field	Datapoint, information	Path in ACS menu tree	Example
1	Plant name	Commissioning > Central communication unit > Plant name	School building East
2	Phone number plant	Commissioning > Central communication unit > Phone number plant	0129876543
3	User-defined text for the fault input <b>and</b> user-defined text for the input <b>and</b> its numbers (1 or 2)	Commissioning > Faults > Text fault input 1 (or 2) Commissioning > Texts > Text for... Input	Burner (Input 1)
4	User-defined text for fault	Commissioning > Faults > Text for: Fault*	Fault
	User-defined text for no fault	Commissioning > Faults > Text for: No fault*	No fault

\* With ACS7... versions 4.0 and 4.01: "Fault" or "No fault"

OZW771 internal fault status message

Field	Datapoint, information	Path in ACS menu tree	Example
1	Plant name	Commissioning > Central communication unit > Plant name	School building East
2	Phone number plant	Commissioning > Central communication unit > Phone number plant	0129876543
3	Type of central communication unit*	Commissioning > Central communication unit > Type	OZW771.10
4	Synco™ fault text**		>1 clock time master
	User-defined text for no fault	Commissioning > Faults > Text for... No fault	No fault

\* Automatic generation according to the path

\*\* According to the Synco™ fault code list (refer to the relevant device)

Device fault (at the fault inputs of a Synco™ device)

Field	Datapoint, information	Path in ACS menu tree	Example
1	Plant name	Commissioning > Central communication unit > Plant name	School building East
2	Phone number plant	Commissioning > Central communication unit > Phone number plant	0129876543
3	User-defined text for the device <b>and</b> device number according to the device list <b>and</b> name of the Synco™ device*	Commissioning > Texts > Text for... Device	Device 8 Controller South zone
4	<b>If available</b> , Synco™ fault text** of the relevant Synco™ device, <b>otherwise</b> user-defined text for the fault <b>or</b>	Commissioning > Texts > Text for... Fault	Aux 1 Fault
	User-defined text for no fault	Commissioning > Texts > Text for... No fault	No fault

\* To be entered on the respective Synco™ device; path dependent on the device type

\*\* According to the Synco™ fault code list (refer to the relevant device), depending on the language of the relevant device

Device fault  
(Synco™ device internally)

Field	Datapoint, information	Path in ACS menu tree	Example
1	Plant name	Commissioning > Central communication unit > Plant name	School building East
2	Phone number plant	Commissioning > Central communication unit > Phone number plant	0129876543
3	User-defined text for device <b>and</b> device number according to the device list, <b>and</b> name of Synco™ device*	Commissioning > Texts > Text for... Device	Device 8 Controller South zone
4	<b>If available</b> , Synco™ fault text** of the relevant Synco™ device, <b>otherwise</b> user-defined text for the <b>fault or</b>	Commissioning > Texts > Text for... Fault	> 1 clock time master
	User-defined text for no fault	Commissioning > Texts > Text for... No fault	Fault No fault

\* To be entered on the respective Synco™ device; path dependent on the device type

\*\* According to the Synco™ fault code list (refer to the relevant device), depending on the language of the relevant device

### Pager message with 160 characters

Message at OZW771  
fault input

Field	Datapoint, information	Path in ACS menu tree	Example
1	Occurrence time		19.03.2004 09:55:21
2	Plant name	Commissioning > Central communication unit > Plant name	School building East
3	Phone number plant	Commissioning > Central communication unit > Phone number plant	0129876543
4	User-defined text for the fault input, <b>and</b> user-defined text for the input, <b>and</b> its number (1 or 2)	Commissioning > Faults > Text fault input 1 (or 2) Commissioning > Texts > Text for... Input	Burner (Input 1)
	User-defined text for fault	Commissioning > Faults > Text for: Fault*	Fault
	User-defined text for no fault	Commissioning > Faults > Text for: No fault*	No fault

\* With ACS7... versions 4.0 and 4.01: "Fault" or "No fault"

OZW771 internal fault  
status message

Field	Datapoint, information	Path in ACS menu tree	Example
1	Occurrence time		19.03.2004 09:55:21
2	Plant name	Commissioning > Central communication unit > Plant name	School building East
3	Phone number plant	Commissioning > Central communication unit > Phone number plant	0129876543
4	Type of central communication unit*	Commissioning > Central communication unit > Type	OZW771.10
5	Synco™ fault text**		>1 clock time master
	User-defined text for no fault	Commissioning > Texts > Text for... No fault	No fault

\* Automatic generation according to the path

\*\* According to the Synco™ fault code list (refer to the relevant device)

Device fault (at the fault inputs of a Synco™ device)

Field	Datapoint, information	Path in ACS menu tree	Example
1	Occurrence time		19.03.2004 09:55:21
2	Plant name	Commissioning > Central communication unit > Plant name	School building East
3	Phone number plant	Commissioning > Central communication unit > Phone number plant	0129876543
4	User-defined text for the device <b>and</b> device number according to the device list <b>and</b> name of the Synco™ device*	Commissioning > Texts > Text for... Device	Device  8  Controller South zone
5	<b>If available</b> , Synco™-fault text** of the relevant Synco™ device, <b>otherwise</b> user-defined text of fault, <b>or</b>	Commissioning > Texts > Text for... Fault	Aux 1  Fault
	User-defined text for no fault	Commissioning > Texts > Text for... No fault	No fault

\* To be entered on the respective Synco™ device; path dependent on the device type

\*\* According to the Synco™ fault code list (refer to the relevant device), depending on the language of the relevant device

Device fault (Synco™-device internally)

Field	Datapoint, information	Path in ACS menu tree	Example
1	Occurrence time		19.03.2004 09:55:21
2	Plant name	Commissioning > Central communication unit > Plant name	School building East
3	Phone number plant	Commissioning > Central communication unit > Phone number plant	0129876543
4	User-defined text for the device <b>and</b> device number according to the device list <b>and</b> name of the Synco™ device*	Commissioning > Texts > Text for... Device	Device  8  Controller South zone
5	<b>If available</b> , Synco™-fault text** of the relevant Synco™ device, <b>otherwise</b> user-defined text of fault, <b>or</b>	Commissioning > Texts > Text for... Fault	> 1 clock time mast  Fault
	User-defined text for no fault	Commissioning > Texts > Text for... No fault	No fault

\* To be entered on the respective Synco™ device; path dependent on the device type

\*\* According to the Synco™ fault code list (refer to the relevant device), depending on the language of the relevant device

### 6.3.4 Fault status messages to other receivers

Other types of fault status message receivers are:

- Fax
- E-mail

Contents and representation correspond to an SMS with 160 characters. The prefix is sent along to control the relevant provider service.

### 6.3.5 System report to the ACS

The representation of the system report to the ACS is similar to that of the fault status messages. The system report informs periodically (depending on the parameter settings) about the 2 plant states, that is, OK (plant OK) or N.OK (plant not OK).

The display of the ACS includes:

Column	Datapoint, information	Path in ACS menu tree
1	Type of central communication unit, automatically generated	
2	Transmission time	
3	Phone number plant	Commissioning > Central communication unit > Phone number plant
4	Plant name	Commissioning > Central communication unit > Plant name

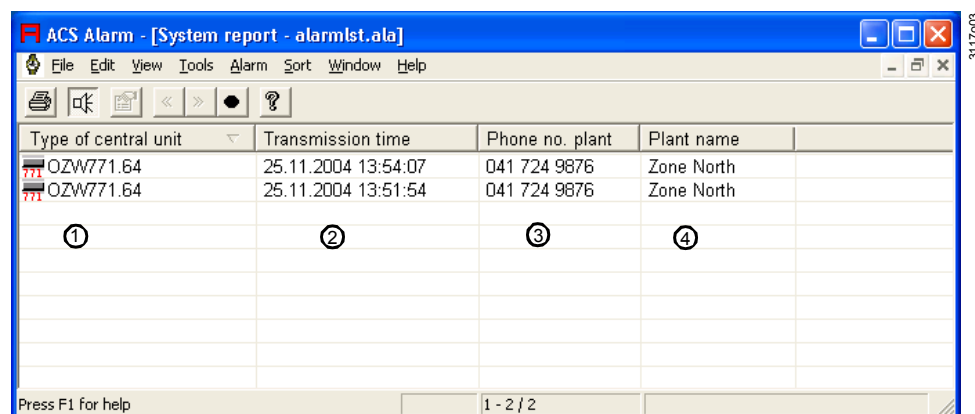

Display example of a system report

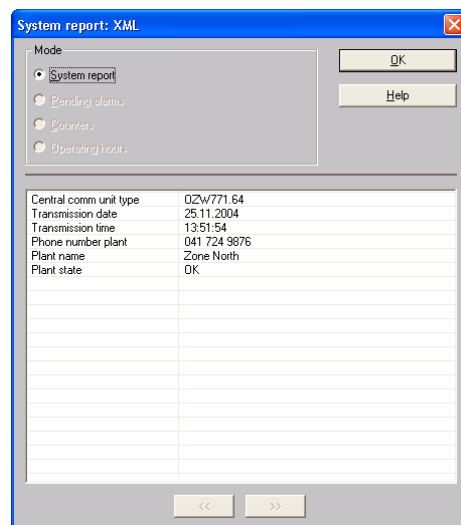

Detail view, plant OK

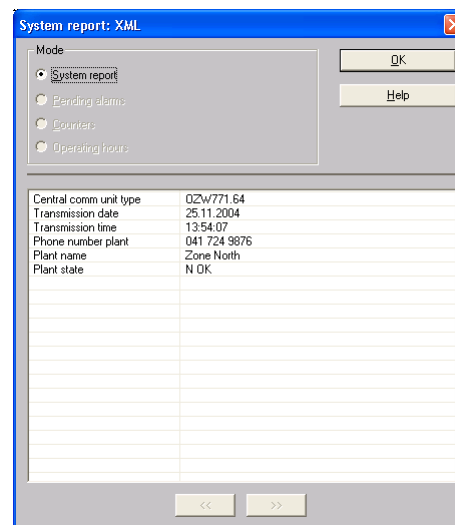

Detail view, plant not OK

### 6.3.6 System report to mobile phone (SMS)

The representation of the system report as SMS is pretty much the same as that of the fault status messages. The system report informs periodically (depending on the parameter settings) about the plant state, that is, fault-free or not fault-free.

	<i>Datapoint, information</i>	<i>Path in ACS menu tree</i>	<i>Example</i>
1	Date and time of day of central communication unit	–	19.03.2004 09:55:21
2	Plant name	Commissioning > Central communication unit > Plant name	School building East
3	Phone number plant	Commissioning > Central communication unit > Phone number plant	0129876543
4	User-defined name of system report	Commissioning > Texts > Text for... System report	System report
5	Plant state: Fault-free		OK
	Not fault-free		N.OK

### 6.3.7 System report to pager

The representation of the system report at the pager is very similar to that of fault status messages, but is dependent on the number of available fields.

Note on the number of characters

**Pager messages with max. 20 characters**

For limitation of the number of characters per field, the restrictions are basically the same as those that apply for the fault status messages at the pager.

If the system report is due, the plant sends its phone number to the pager. The enduser must then make contact with the plant (starting the ACS, establishing a connection, etc.).

<i>Field</i>	<i>Datapoint, information</i>	<i>Path in ACS menu tree</i>	<i>Example</i>
1	Phone number plant	Commissioning > Central communication unit > Phone number plant	0129876543

**Pager messages with max. 40 characters**

If the system report is due, the plant sends its phone number and the keyword for system report to the pager. The enduser must then make contact with the plant (starting the ACS, establishing a connection, etc.).

<i>Field</i>	<i>Datapoint, information</i>	<i>Path in ACS menu tree</i>	<i>Example</i>
1	Phone number plant	Commissioning > Central communication unit > Phone number plant	0129876543
2	User-defined text of system report	Commissioning > Texts > Text for... System report	System report

**Pager messages with max. 80 characters**

In addition to that with 40 characters, the system report includes the plant name and the plant state (fault-free or not fault-free). To learn about the cause of the fault, the enduser must make contact with the plant (starting the ACS, establishing a connection, etc.).

<i>Field</i>	<i>Datapoint, information</i>	<i>Path in ACS menu tree</i>	<i>Example</i>
1	Plant name	Commissioning > Central communication unit > Plant name	School building East
2	Phone number plant	Commissioning > Central communication unit > Phone number plant	0129876543
3	User-defined text of system report	Commissioning > Texts > Text for... System report	System report
4	Plant state: Fault-free		OK
	Not fault-free		N.OK

**Pager message with 160 characters**

In addition to that with 80 characters, the system report includes the occurrence time. To learn about the cause of the fault, the enduser must make contact with the plant (starting the ACS, establishing a connection, etc.).

<i>Field</i>	<i>Datapoint, information</i>	<i>Path in ACS menu tree</i>	<i>Example</i>
1	Occurrence time		19.03.2004 09:55:21
2	Plant name	Commissioning > Central communication unit > Plant name	School building East
3	Phone number plant	Commissioning > Central communication unit > Phone number plant	0129876543
4	User-defined text of system report	Commissioning > Texts > Text for... System report	System report
5	Plant state: Fault-free		OK
	Not fault-free		N.OK

### 6.3.8 System report to other receivers

The system report can also be routed to the following types of message receivers:

- Fax
- E-mail

Contents and representation correspond to an SMS with 160 characters. The prefix is sent along to control the relevant provider service.

## 6.4 Plant operation with ACS7...

**Introduction**

In operation, the enduser can access all datapoints covered by this section, that is, datapoints with read and (if applicable) write access.

It is assumed that the enduser is more or less familiar with the ACS plant operating software.

## 6.4.1 Creating a new plant with ACS Operation

1. Start ACS Operation and log on with the service password.
2. Plant > New > Plant...
3. Dialog "Save As" opens. Enter the file name, e.g. Building WEST.

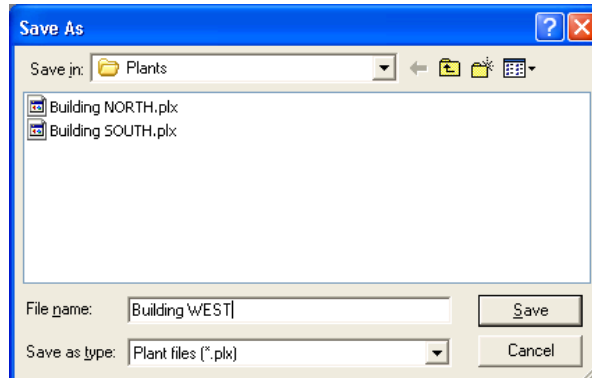

4. Select **Save**:  
The "General" dialog opens.

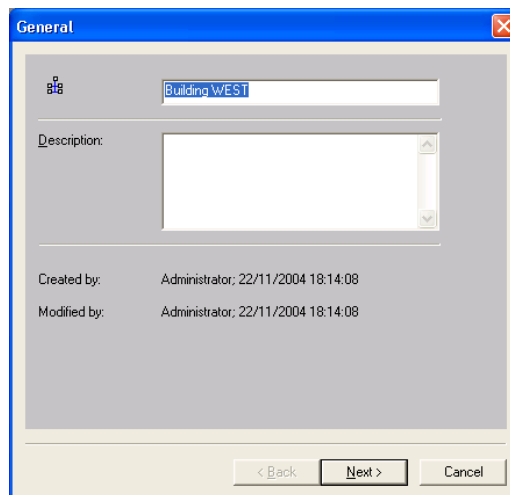

5. Select **Next >**:  
The "Communication" dialog opens

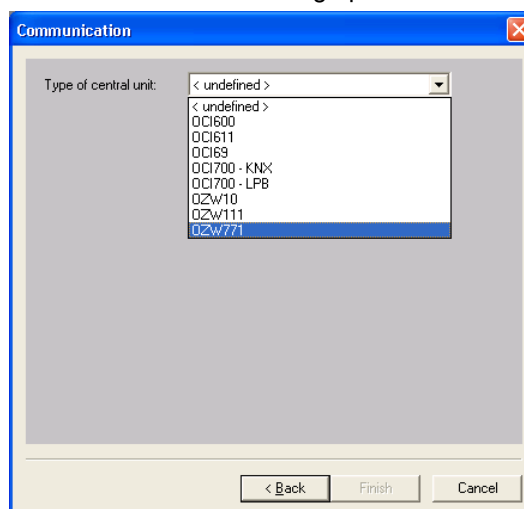

6. Select Type of central unit: OZW771.

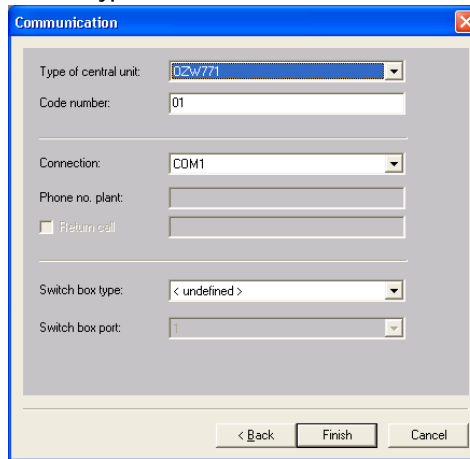

7. The illustration shows the as supplied state.

Select **Finish**: The ACS window opens

Code: Select in accordance with the setting made when the central communication unit was commissioned (refer to section 4.2 “Central communication unit”)

Connection: Select the connection used on the PC

8. **Plant > Connect** (or  on the menu bar)

9. **Plant > Update device list**. “Read plant information” and “Update reference datapoints” will appear.

10. Choose **Applications > Popcard...**

11. Extend view of tree structure until OZW771 appears.

12. Extend view of  Standard so that the relevant Popcards appear.

## 6.4.2 Updating an existing plant

1. Start ACS Operation and log on with the service password.

2. **Plant > Open...**

3. The “Open plant” dialog appears. Click on the file name, e.g. Building WEST.

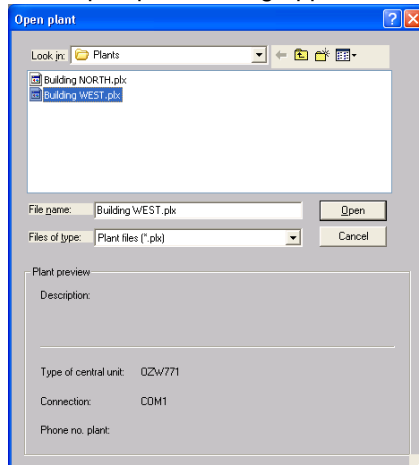

4. Select **Open**: The plant is opened.

5. **Plant > Connect** (or  on the menu bar).

6. **Plant > Update device list**. “Read plant information” and “Update reference datapoints” will appear.

7. Choose **Applications > Popcard...**

8. Extend view of tree structure until OZW771 appears.





9. Extend view of  Standard so that the relevant Popcards appear.



## 6.5 Inputs

### Datapoints

For each of the 2 fault inputs, the current state is displayed.

<i>Datapoint</i>	<i>Explanation, example</i>		
Fault input 1	The fault can be signaled by an open or closed contact at fault input 1. The relevant parameter settings are explained in subsection 4.6.1 "Fault inputs". For both states, user-defined Text can be entered: Commissioning > Faults > Text for: Fault* or Commissioning > Faults > Text for: No fault*		









\* With ACS7... versions 4.0 and 4.01: "Fault" or "No fault"

The statements made about fault input 1 also apply to fault input 2.

## 6.6 Time of day / date

### Datapoints

Function "Time of day / date" includes 3 datapoints:

<i>Datapoint</i>	<i>Explanation, example</i>		
Time of day / date	Here, the date and the time of day can be set. Entry is made via a calendar.		
Summer time start	Setting the date for the change to summertime means that on the first Sunday after that date the time of day will be set forward from 02:00 (wintertime) to 03:00 (summertime)		
Winter time start	Setting the date for the change to wintertime means that on the first Sunday after that date the time of day will be set back from 03:00 (summertime) to 02:00 (wintertime)		

### Summertime and wintertime

The change from summertime to wintertime, and vice versa, is made automatically. The dates are in accordance with international standards; they can be readjusted should the standards change.

### Backup of time switch

The central communication unit has a yearly clock with a reserve of maximum 12 hours. The reserve is provided by a capacitor with a lifetime of more than 10 years. On completion of the reserve, the clock starts with 1.1.2000, 00:00:00.

### 6.6.1 System time fault

#### Detection and fault handling

On power restoration, the central communication unit determines whether the reserve has elapsed.

#### Configuration as master

If the central communication unit is configured as the master and the reserve has elapsed, the central communication unit will generate fault 5003 (invalid time of day).

#### Configuration autonomous

If the clock of the central communication unit is configured as autonomous and the reserve has elapsed, the central communication unit will generate fault 5003 (invalid time of day).

#### Configuration as slave

If no system time is received for at least 21 minutes, the central communication unit will generate fault 5001 (system time failure). The time-dependent functions of the central communication unit (e.g. the system report) continue to be executed on the basis of the local time.









## 6.7 Faults

The faults at the fault inputs of the central communication unit are displayed on the ACS menu: **Applications > Popcard**, menu tree: **Faults**

### 6.7.1 Fault inputs

Here, all information about the fault status messages is given the central communication unit collects at its fault inputs.

#### Datapoints

<i>Datapoint</i>	<i>Explanation, example</i>		
Text fault input 1	Here, a description of the plant element monitored with the contact is given. Associated text (optional) was entered in menu tree Commissioning > Faults during commissioning. The enduser can change this text at any time (refer to subsection 4.6.1 "Fault inputs"; maximum 20 characters)		
State fault input 1	A contact of an external device (e.g. thermostat) connected to the fault input opens or closes, thereby indicating a fault. For more information, refer to subsection 4.6.1 "Fault inputs" For both states, user-defined text can be entered: Commissioning > Faults > Text for: Fault* or Commissioning > Faults > Text for: No fault*		
Last change	The time given is identical with the occurrence time transmitted to the message receivers		

\* With ACS7... versions 4.0 and 4.01: "Fault" or "No fault"

The statements made about fault input 1 also apply analogously to fault input 2.







#### Faults of the fault inputs

<i>Fault central communication unit</i>	<i>Fault number</i>	<i>For information, refer to subsection</i>
Fault input 1 (Aux1)	9001	4.6.1, 6.7.1, 6.7.5
Fault input 2 (Aux2)	9002	4.6.1, 6.7.1, 6.7.5

### 6.7.2 Central communication unit

Here, information about faults is given the central communication unit detects in itself.

#### Datapoints

<i>Datapoint</i>	<i>Explanation, example</i>		
Fault information	The information provided includes the date on which the fault occurred, the time of day and the fault number. Example: 23.07.04; 10:24; 5001		
Fault text	This datapoint is the Synco™ fault text; it is assigned to the fault number. Example: 5001 = System time failure		

#### Internal fault

Self-supervision displays the following internally detected faults:

<i>Fault central communication unit*</i>	<i>Fault number</i>	<i>For information, refer to subsection</i>
No fault	0000	6.7.5
No bus power supply	5000	6.7.5
System time failure**	5001	6.6.1, 6.7.5
>1 clock time master	5002	4.3.2, 6.7.5

<i>Fault central communication unit*</i>	<i>Fault number</i>	<i>For information, refer to subsection</i>
Invalid time of day	5003	6.6.1, 6.7.5
Commiss: Device not found	5011	4.4.4, 4.4.5, 6.7.5
Device failure	5012	4.4.3, 6.7.4, 6.7.5
No modem communication	5021	4.4.3, 6.7.5, 6.8.1
Message receiver not reached***	5022	6.7.5, 6.8.1
>1 id bus address	6001	6.7.5

\* Depending on the language selection made on the central communication unit

\*\* As clock time slave

\*\*\* With ACS7... versions 4.0 and 4.01: "Alarm receiver not reached"

Every internal fault of self-supervision is handled individually and generates a message. If there are several internal faults, all faults are delivered to the message receivers.



### Special handling

If no device is entered on the device list (as supplied, all devices are inactive; also refer to subsection 4.4.2 "Generating the device list"), fault 5000 (no bus power supply) will not be generated. This way, the central communication unit can be used for the exclusive supervision of the fault inputs.

## 6.7.3 Konnex

Faults reported to the Konnex bus originate from the Synco™ devices entered on the device list or from the central communication unit itself. For details, refer to the menu tree under [Device 1](#) and [Device 2](#) (see following subsection).

### Datapoints

<i>Datapoint</i>	<i>Explanation, example</i>		
Fault information	The information provided includes the date on which the fault occurred, the time of day and the fault number. Example: 23.07.04; 10:24; 5001	<input type="radio"/>	<input type="radio"/>
Fault text	This datapoint is the Synco™ fault text; it is assigned to the fault number. Example: 5001 = System time failure	<input type="radio"/>	<input type="radio"/>
Area	Part of the network address of the Synco™ device causing the fault	<input type="radio"/>	<input type="radio"/>
Line		<input type="radio"/>	<input type="radio"/>
Device address		<input type="radio"/>	<input type="radio"/>
Device	This is the number of the entry of the relevant device on the device list or the central communication unit itself	<input type="radio"/>	<input type="radio"/>

### Synco™ devices

For each Synco™ device, faults 5012 (device failure) and 5011 (device not found during commissioning) are individually generated on the device list (for details, refer to subsection 6.7.4 " Device 1, device 2, etc.").

On the central communication unit, fault status messages are only stored from those Synco™ devices that are entered on the device list and are then delivered to the message receivers.

### Special handling

In the event of a system time failure, all time-of-day slaves report the fault at the same time. Without special handling, this would lead to a strong concentration of fault status messages vis-à-vis the message receivers. For this reason, a system time failure is reported only once. In that case, the reporting device is always the central unit.

### Querying faults of Synco™ devices

The faults from Synco™ devices in the plant passed on via Konnex bus appear on the ACS menu [Application > Popcard](#), menu tree: [Faults > Device 1 \(Device 2 etc.\) > ...](#)

For each Synco™ device connected to the Konnex, ACS opens a specific window.

Every fault status message of a Synco™ device entered on the device list is stored with the following information:

- Time of occurrence
- Synco™ fault number
- Alarm priority
- Fault text
- Device name
- Network address

If the fault status message does not state the time of occurrence, the central communication unit will set the current time. The transmission time used is the point in time the transmission is made. Of all bus users the Konnex bus only transmits the oldest fault with the highest priority. The central communication unit receives it and passes it on. There is **no** automatic acknowledgement of fault status messages via the Konnex bus.



### Fault number list

Lists of the Synco™ fault numbers are contained in the documentation of the relevant devices.

### 6.7.4 Device 1, device 2, etc.

The Synco™ devices connected to the Konnex bus report their faults to the central communication unit via the Konnex bus.

### Datapoints per device

<i>Datapoint</i>	<i>Explanation, example</i>		
Device name	User-defined name of the device monitored. Entry of the device itself or via ACS	<input type="radio"/>	<input type="radio"/>
Device state	Display: <ul style="list-style-type: none"> <li>• Not checked</li> <li>• Checking</li> <li>• Present</li> <li>• Not present</li> <li>• Failed</li> </ul> For details, refer to subsection "Representation of the various choices"	<input type="radio"/>	<input type="radio"/>
Device type	Stated is the type reference of a Synco™ room units, e.g. QAW740	<input type="radio"/>	<input type="radio"/>
Fault information	The information provided includes the date on which the fault occurred, the time of day and the Synco™ fault number Example: 23.07.04; 10:24; 5001	<input type="radio"/>	<input type="radio"/>
Fault text	This datapoint is the Synco™ fault text; it is assigned to the Synco™ fault number. Example: 5001 = System time failure	<input type="radio"/>	<input type="radio"/>
Area	Part of the network address of the Synco™ device causing the fault	<input type="radio"/>	<input type="radio"/>
Line		<input type="radio"/>	<input type="radio"/>
Device address		<input type="radio"/>	<input type="radio"/>

These datapoints repeat themselves for every Synco™ device connected to the Konnex bus.

### Device list state

On the device list, each device connected to the Konnex bus is identified by the Device state. ACS uses this state in the menu tree representation.

The following states are defined:

<i>State</i>	<i>Description</i>
Not checked	The entry on the device list is inactive or the device information has not yet been updated after the Active setting

Checking	Temporary state during the time the device is checked
Present	The device is available on Konnex and communicates with the central communication unit
Failed	The device does not respond anymore (refer to subsection 6.7.4 “Device 1, device 2, etc.”)
Not present	The device is not available or is not a Synco device

Available choices

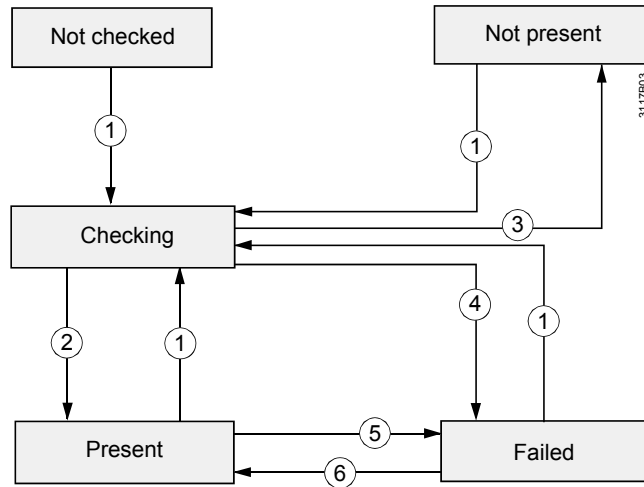

The states are described in subsection 4.4.5 under “Device list state“.

Action	Procedure	Fault status message
1	Update the device information or apply power	None
2	Device replies	None
3	Device does not reply*	No fault → 5011 Commissioning: Device not found
4	Device does not reply**	No fault → 5012 Device failure
5	<ul style="list-style-type: none"> <li>If the device does not call with the regular fault status message at 30-minute intervals, or</li> <li>If the device does not call after 3 unsuccessful queries when the check is made every 61 minutes</li> </ul>	No fault → 5012 Device failure
6	If a lost device calls spontaneously by sending a fault status message	Device failure → No fault

\* At Update device information (refer to subsection 4.4.3 “Updating device information”)

\*\* After applying power

The temporary Checking state is active during the time the device list is created.

Monitoring the device list

Many Konnex devices deliver a “sign of life“ every 30 minutes in the form of the fault status message or some other message. This message is used to monitor the Synco™ devices contained on the device list. But there are also Synco™ devices that do not deliver “signs of life“, such as the QAW740 room unit.

If there is no “sign of life“, the central communication unit waits 61 minutes. Then, the central unit interrogates the device identification.

If a reply is received, the device will be registered as Present and the waiting time starts again.

However, if the central communication unit does not receive a reply, it makes 2 more interrogations.

If there is still no reply, the device state of the relevant device is set to Failed and fault status message 5012 (device failure) will be generated.

The device state will change back to Present only if:

- A "sign of life" is received from the relevant device
- The device calls after choosing Create device list or Update device information

When power is restored after a power failure, monitoring of the Synco™ devices on the device list will start after 61 minutes.

If fault 5000 (no bus power supply) occurred, monitoring is stopped and fault 5012 (device failure) will not be generated.

## 6.7.5 Fault handling through the central communication unit

### Acknowledging and deleting faults

Using the ACS, the fault states of the central communication unit, the fault inputs and the fault states of the Synco™ devices can be queried. Successful querying of the current state does not change the fault's state and does not delete a message; also, the fault is not considered acknowledged.

The central communication unit does not use a fault history.

### Storing fault status messages

**Internal** faults and the messages of the fault inputs are stored in a queue until delivered to the message receivers. 10 faults per message receiver can be stored.

**External** faults (faults of devices connected to the Konnex bus) are not included in the queue. If the fault state of an external device connected to the Konnex bus changes before it was reported, only the new state will be signaled.

If the central communication unit receives the same fault status message several times before it can deliver the message, it will generate **exactly 1** message.

### Indicating fault status messages

The central communication unit has a fault LED. It is used to indicate pending system faults, independent of whether they shall be or have already been delivered via the RS-232 port. The fault LED extinguishes only when there are no more faults in the system.

<i>Fault central communication unit and Konnex devices</i>	<i>Fault number</i>	<i>Fault LED</i>
No fault*	0000	Dark
Fault of an external device contained on the device list	xxxx**	Lit
No bus power supply	5000	Lit
System time failure (as slave)	5001	Flashing
>1 clock time master	5002	Flashing
Local system time not set (or not correctly set)	5003	Flashing
Device not found during commissioning	5011	Flashing
Device failure	5012	Lit
No modem communication	5021	Flashing
Message receiver not reached***	5022	Flashing
Device with identical network address	6001	Flashing
Fault input 1	9001	Flashing
Fault input 2	9002	Flashing

\* Neither in the central communication unit nor at an external Konnex device

\*\* Any 4-digit number ≠ 0

\*\*\* With ACS7... versions 4.0 and 4.01: "Alarm receiver not reached"

Faults 5000 (no bus power supply), 5012 (device failure) and faults of external devices that are contained on the device list are of external origin; for this reason, the fault LED **lights up** when they are detected. With all other faults, the fault LED **flashes**.

### Bus power supply supervision inactive

Fault 5000 (no bus power supply) is generated only when the device list contains activated devices.

### Fault on Konnex bus

The central communication unit always delivers the most severe of all internal faults and faults of the fault inputs via Konnex bus.

## 6.8 Message receivers

### 6.8.1 Functions

---

- When detected, the central communication unit sends fault status messages immediately to the message receivers. However, after communication via the telephone network, the central communication unit observes a message interval of at least 2 minutes, which can be parameterized
- If there were several state changes, all of them are buffered in a queue. The messages are delivered according to the settings made on the message receiver (message triggering)
- For each of the 2 message receivers, the central communication unit stores 10 faults
- If the central communication unit cannot deliver a fault status message, it repeats the message using the parameterized message interval until delivery is successful, or until the number of parameterized repetitions is reached
- The 2 internal faults 5021 (no modem communication) and 5022 (message receiver not reached\*) are not transmitted to the message receivers via the RS-232 port because transmission can take place only when the problem is rectified

\* With ACS7... versions 4.0 and 4.01: "Alarm receiver not reached"

### 6.8.2 Modem connection

---

#### Message interval

Each time a communication is built up from the central communication unit via RS-232 and the modem (irrespective of successful or not and independent of the message receiver or the phone number), the central communication unit waits for the message interval to elapse. This ensures that the central communication unit can be called from externally between 2 messages (for setting, refer to subsection 4.5.2 "Modem connection").

- If messages for phone number 1 or 2 occur in greater intervals than the parameterized message interval, they are delivered immediately
  - If there is only 1 message – e.g. for phone number 1 – and it was not possible to deliver it, an attempt is made to send a message to that phone number until the maximum number of calls is reached while observing the message interval
  - If there are messages for phone numbers 1 **and** 2, and it was not possible to deliver them, an attempt is made to call both numbers while observing the message interval
- One exception is the modem reset button. When pressed, the lock by the message interval will not be observed.

#### Example

If there are 3 messages for SMS message receivers for phone number 1 and if all of them can be successfully delivered, phone number 2 has to wait until 3 message intervals have elapsed. If the setting is 2 minutes (as supplied), that time will be 6 minutes. However, as soon as an attempt to reach phone number 1 is unsuccessful, it is the turn of phone number 2 after the message interval has elapsed.

#### Message repetition

For each message receiver and individual message, a maximum number of dialing repetitions has been defined (for setting, refer to subsection 4.5.2 "Modem connection"). This helps reduce phone charges if the partner station is not ready for building up the connection and for reception.

If, in the case of setting None, 1, 2 or 3, the message could not be successfully delivered, fault 5022 (message receiver not reached\*) is generated and the message in the waiting queue will be canceled.

This fault will be reset when:

- One of the next messages to the same message receiver was successfully delivered
- Actuating the RS-232 selector S1 (triggers a reset of RS-232 communication)

Fault 5022 (message receiver not reached\*) is not generated when fault 5021 (no modem communication) has already been generated

The counter for the maximum number of dialing repetitions is reset to 0 each time a new message is sent.

\* With ACS7... versions 4.0 and 4.01: "Alarm receiver not reached"

## Order

The central communication unit sends pending, undelivered fault status messages to the message receivers and establishes a connection, if necessary. The order of the fault status messages to be delivered is in accordance with their chronological occurrence. In the case of messages to ACS as a message receiver, all pending messages are sent in successive order when the telephone connection is made. Only then will the connection be aborted and the message interval be awaited. In the case of messages to all other message receivers, the message interval between 2 messages is always observed (refer to section 4.5.2 "Modem connection").

Representation of order:

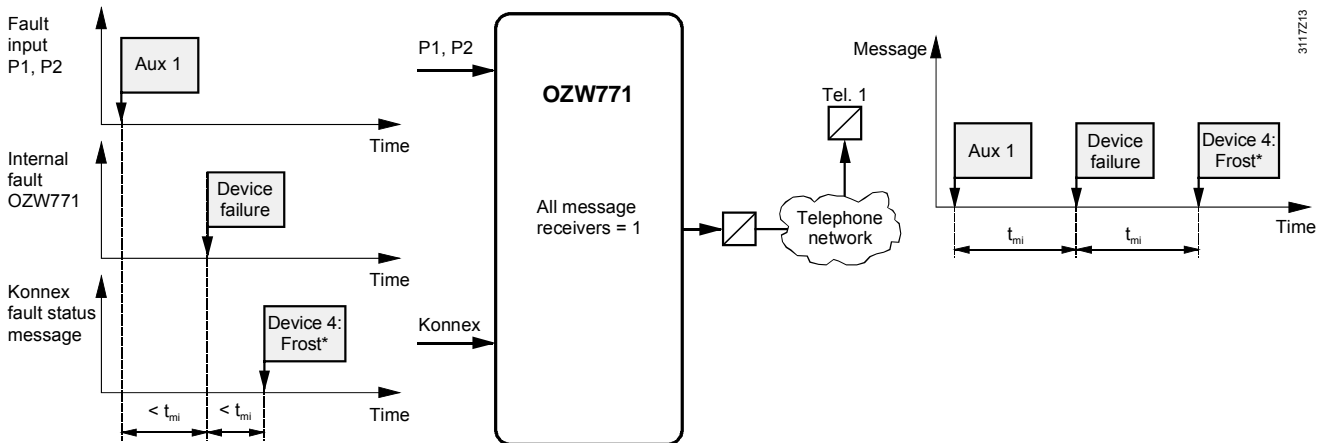

\* From all monitored Synco™ devices on the Konnex bus, only the most severe fault is signaled and indicated. When removed, the most severe of the remaining faults is signaled and indicated. This applies especially to the freely programmable inputs.

$t_{mi}$  Message interval

For all fault sources and the system report, it is to be parameterized which of the 2 message receivers shall receive the message, or if both shall receive them (for more details, refer to section 6.7 "Faults" and subsection 6.3.5 "System report to the ACS" and following).

## Alternating the message receivers

If, simultaneously, there are undelivered messages / fault status messages to both message receivers, the central communication unit delivers alternately all messages intended for message receiver 1 (phone number 1), and then those intended for message receiver 2 (phone number 2). It cannot be predicted which of the message receivers will receive the messages first.



### Alternating the message receivers

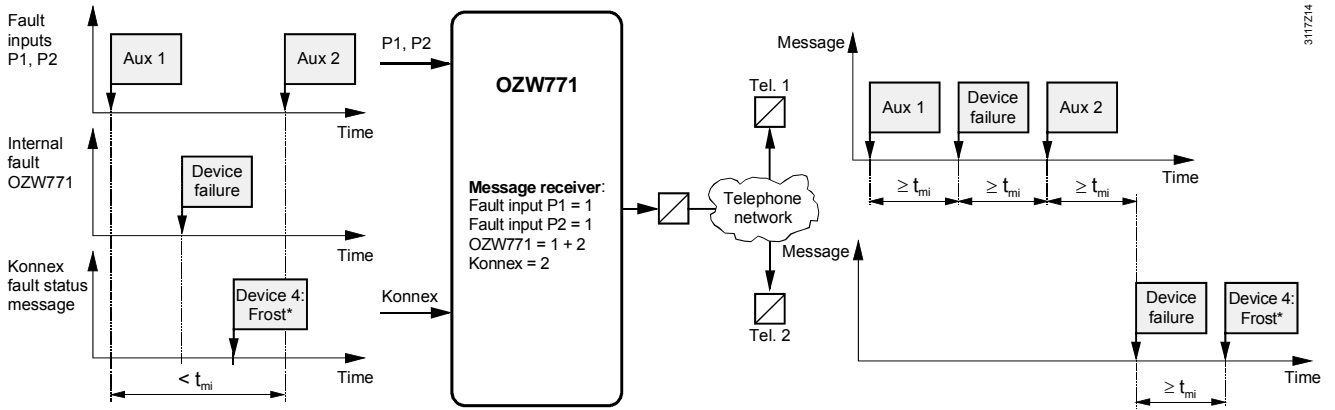

\* From all monitored Synco™ devices on the Konnex bus, only the most severe fault is signaled and indicated. When removed, the most severe of the remaining faults is signaled and indicated. This applies especially to the freely programmable inputs.

$t_{mi}$  Message interval

### Delay and number of messages delivered

The central communication unit delivers messages to message receiver type ACS\* immediately, provided there is a direct connection to ACS. Messages to all other types of message receivers are sent exclusively via modem.

If ACS accesses the central communication unit via modem, the central communication unit may not deliver any messages. To deliver messages via modem, it is always the central communication unit **itself** that calls. This ensures that it is always the parameterized operator station receiving the messages, and not any of the other stations that has made an accidental call.

After abortion of the connection by ACS, it may take a period of time up to the parameterized message interval for a pending message to be delivered.

There is no general delay time that would delay the delivery of messages.

\* With ACS7... versions 4.0 and 4.01: "PC"

### 6.8.3 Substitution of characters in text messages

Since not all characters are permitted for transmission to all types of message receivers, character substitution tables must be used, depending on the type of communication protocol:

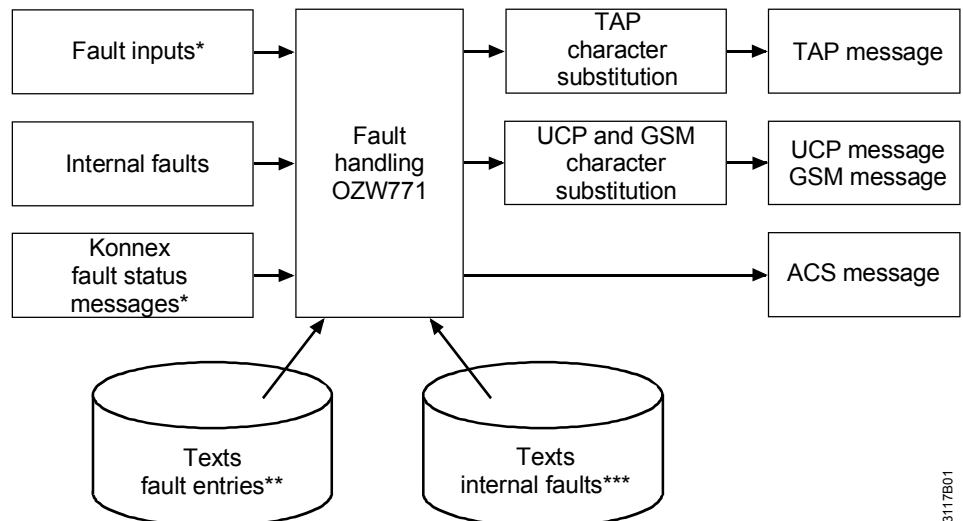

\* These sources can contain special characters!

\*\* Refer to subsection 4.6.1 "Fault inputs"

\*\*\* Refer to section 4.8 "Text"

The text fields support all ASCII characters up to 127 in the fault texts used up to now.

For communication via the telephone networks, restrictions must be applied since the ASCII character set and the extended character set in the fault texts do not fully agree with the character sets used by the telephone networks.

For the characters in the fault text, substitution characters for message text are used, if possible (refer to the following table). All ASCII characters smaller than ASCII-32 in the fault text are replaced by ? (question mark).

Brackets [ ] are replaced by parentheses ( ) and @ by an \* (asterisk). It is recommended to always use \* in place of @; the telephone providers presently operating support the \*.

The characters that, in the telephone network, do not correspond to the ASCII table are replaced by ? . Also, for UCP and GSM, the ASCII-\$ is replaced by the \$ sign used in telephone networks. All numbers that are not listed will not be replaced.

ASCII value	Character in fault text		Replaced by character in message text	
			UCP and GSM	TAP
35	#	#	?	?
36	\$	\$	"GSM-\$"	?
92	\	\	?	?
94	^	^	?	?
95	_	_	?	?
96	\	\	?	?
123	{	{	?	?
124			?	?
125	}	}	?	?
126	~	~	?	?
127	DEL	DEL	?	?
129	space	space	space	?
130	,	,	.	?
138	Š	Š	S	?
139	<	<	<	?
142	Ž	Ž	Z	?
144	space	space	space	?
146	,	,	,	?
147	"	"	"	?
148	"	"	"	?
158	ž	ž	z	?
193	Á	Á	A	?
194	Â	Â	Ä	?
195	Ã	Ã	Ä	?
196	Ä	Ä	Ä	?
199	Ç	Ç	C	?
201	É	É	É	?
202	È	Ê	E	?
203	Ë	Ë	E	?
205	Í	Í	I	?
206	Î	Î	I	?
209	Ñ	Ñ	N	?
211	Ó	Ó	O	?
212	Ô	Ô	Ö	?
213	Õ	Õ	Ö	?
214	Ö	Ö	Ö	?
217	Û	Û	U	?
218	Ú	Ú	U	?
219	Û	Û	U	?
220	Ü	Ü	Ü	?

ASCII value	Character in fault text		Replaced by character in message text	
			UCP and GSM	TAP
221	Ý	Ý	Y	?
225	á	á	a	?
226	â	â	a	?
227	ă	ă	ă	?
228	ä	ä	ä	?
231	ç	ç	ç	?
233	é	é	é	?
234	ê	ê	e	?
235	ë	ë	e	?
237	í	í	i)	?
238	î	î	i)	?
241	ñ	ñ	n	?
243	ó	ó	o	?
244	ô	ô	o	?
245	õ	õ	ö	?
246	ö	ö	ö	?
249	ù	ù	u	?
250	ú	ú	u	?
251	û	û	ü	?
252	ü	ü	ü	?
253	ý	ý	Y	?

## 6.9 Device information



Here, the most important data of the central communication unit, the Konnex bus and all Synco™ devices connected to the bus are listed.

The plant operator can enter the phone number of the modem as the plant's phone number; all other datapoints will be generated automatically.

### 6.9.1 Central communication unit

The following data inform the user about the central communication unit:

#### Datapoints

Datapoint	Explanation, example		
Type of central communication unit	The type reference appears, e.g. OZW771.64 (will be generated automatically)	<input type="radio"/>	<input type="radio"/>
Phone number plant	Using this phone number, the plant operator can retrieve plant data. This phone number can be changed by the enduser	<input checked="" type="radio"/>	<input type="radio"/>
Serial number	The serial number refers to the Konnex bus. It is an unambiguous number worldwide	<input type="radio"/>	<input type="radio"/>
Production number	This is the central communication unit's consecutive production number ex works; it can be useful for service purposes	<input type="radio"/>	<input type="radio"/>
Software version	Can be useful for service purposes	<input type="radio"/>	<input type="radio"/>
Operating hours	The central communication unit acquires its number of operating hours via mains voltage and indicates them here	<input type="radio"/>	<input type="radio"/>

#### Hours run counter

The central communication unit has a nonresettable hours run counter. The counter reading is read into EEPROM every night at 00:00 and whenever there is an AC 230 V power failure.

The user can retrieve the current counter reading in menu tree Device information > Central communication unit.



## 6.9.2 Konnex

The following data inform the user about the Konnex bus:



- The most important data of the Konnex plant
- The most important data of the Synco™ devices connected to the Konnex bus (device 1, device 2, etc.). These datapoints repeat themselves for every Synco™ device connected to the Konnex bus

### Datapoints

#### Konnex data

<i>Datapoint</i>	<i>Explanation, example</i>		
Number of devices current	This is the number of Synco™ devices connected to the Konnex bus that are acquired by the central communication unit	<input type="radio"/>	<input type="radio"/>
Number of devices maximum	This number depends on the type of central communication unit	<input type="radio"/>	<input type="radio"/>

#### Device data

<i>Datapoint</i>	<i>Explanation, example</i>		
Device name	Commissioning > Central communication unit > Plant name	<input type="radio"/>	<input type="radio"/>
Device state	E.g. Present	<input type="radio"/>	<input type="radio"/>
Device type	Type reference, e.g. QAW740 for a Synco™ room unit	<input type="radio"/>	<input type="radio"/>
Fault information	The information includes the date on which the fault occurred, the time of day and the fault number. Example: 23.07.04;10:24; 5001	<input type="radio"/>	<input type="radio"/>
Fault text	This datapoint is the Synco™ fault text; it is assigned to the Synco™ fault number. Example: 5001 = System time failure	<input type="radio"/>	<input type="radio"/>
Area	The area relates to the network address and can assume values from 0 to 15	<input type="radio"/>	<input type="radio"/>
Line	The line relates to the network address and can assume values from 0 to 15	<input type="radio"/>	<input type="radio"/>
Device address	The device address relates to the network address and can assume values from 1 to 254	<input type="radio"/>	<input type="radio"/>

## 6.10 Behavior when turning power on and off

### 6.10.1 Sequence of functions when turning power on

When turning power on, the central communication unit puts itself into operation in a controlled way. It is operational after 10 seconds at the latest.

The central communication unit initializes the connected modem, if parameterized. Also, with the GSM modem setting, an AT+-command at 19,200 Baud is delivered, setting the modem to the Baud rate of 9,600.

If internal faults exist, the central communication unit will detect them. If there is a fault, a message will only be generated after a delay of 60 seconds, and delivered via the RS-232 port to the defined message receiver(s).

When turning power on, the central communication unit queries the device data of all devices contained on the device list. Then, failure supervision of the Synco™ devices on the device list starts after a waiting time of 61 minutes.

The entire switch-on process is signaled as follows:

- The green LED lights up (item 5 in the illustration in section 2.2 “Operating elements of the central communication unit”)
- The red LEDs remain dark (items 4 and 6 in the illustration in section 2.2 “Operating elements of the central communication unit”)

The central communication unit operates on AC 230 V mains voltage.

### 6.10.2 Data storage when turning power off

---

If mains voltage fails for more than 0.1 seconds, all relevant data will be stored in non-volatile memory.

Relevant data:

- Complete device list with all fault information and the device address, area and line (network address)
- Operating hours
- Information about the messages already delivered
- Messages about internal faults and about faults at the fault inputs in the order they occurred (queue)



The parameterization data are stored in nonvolatile memory.

The other data are stored in volatile memory and must be retrieved from the Synco™ devices via the Konnex bus on restoration of power.

## 6.11 Quick onsite checks

---

If there seems to be a fault in the plant, the following checks must be made on the central communication unit:

1. Is the green operation LED lit?
2. Are both red LEDs dark (fault LED and programming LED)?
3. Is RS-232 selector S1 set to position ?
4. Is message selector S2 set to position ?

For a detailed description of the individual selector positions and LED functions, refer to section 2.2 “Operating elements of the central communication unit”.



# Index

## A

acknowledge faults .....	66
ACS Alarm .....	45
ACS alarm as message receiver .....	33
ACS device description .....	29
ACS7 .....	9
activating devices .....	30
adding devices .....	30
alarm detail view .....	48
alarm indication .....	14
alarm main view .....	47
alarm popup .....	45
alternating the message receivers .....	69
ascertain network address .....	24
autonomous (system time fault) .....	61
autonomous clock .....	24

## B

backup .....	61
Baud rate .....	25

## C

central communication unit (settings) .....	22
central communication unit internal faults .....	62
check device list .....	66
checking .....	32, 65, 66
clock function .....	24
clock time master .....	24
code .....	23
code number .....	22
command set .....	26
commands (modem) .....	26
commissioning with ACS7 .....	20
communication via Konnex bus .....	11
communication via RS-232 port .....	12
communication via the telephone network .....	13
create device list .....	18
current state fault inputs .....	61

## D

data storage .....	74
datapoint (general) .....	15
date .....	61
default state .....	19
delay of alarms delivered .....	70
delete faults .....	66
description missing .....	65
device 1, device 2, etc. ....	31
device address .....	18, 24

device description .....	29
device information .....	72
device list .....	28
device list state .....	32, 65
device search run .....	19, 29, 30
device state .....	31
display and operating elements .....	14
display internal faults .....	40
documentation .....	9

## E

editing the device list .....	30
e-mail as message receiver .....	35
enduser level .....	15

## F

failed .....	32, 65
fault handling .....	66
fault inputs (central communication unit) .....	39
fault inputs wiring test .....	44
fault inputs, current state .....	61
fault inputs, fault status messages .....	62
fault LED .....	15
fault number list .....	64
fault status message as e-mail .....	55
fault status messages .....	28, 62
fault status messages as SMS .....	48
fault status messages Konnex devices .....	41
fault status messages to fax .....	55
fault status messages to mobile phone .....	48
fault status messages to pager .....	51
fault text .....	32
faults .....	39
faults central communication unit .....	40
faults in plant operation .....	45
faults Konnex bus / devices .....	63
faults Synco™ devices .....	64
faults, delete .....	66
fax .....	55
fax as message receiver .....	35, 55
functions .....	9

## G

generating the device list .....	28
GSM message receiver .....	34
GSM protocol .....	13, 35

## H

hours run counter .....	72
-------------------------	----

<b>I</b>		
indicating fault status messages .....	67	
initialization command .....	25	
input signals fault inputs .....	39	
internal faults central communication unit .....	62	
<b>K</b>		
Konnex bus .....	20, 28	
Konnex bus button .....	14	
Konnex data .....	73	
<b>L</b>		
language.....	23, 40	
line.....	24	
line couplers .....	18	
local commissioning .....	18	
<b>M</b>		
mail as message receiver.....	55	
master .....	24	
master (system time fault).....	61	
maximum number of devices .....	30	
message cycle system report.....	42	
message interval .....	33	
message receiver .....	34, 68	
message receiver ACS alarm.....	33	
message repetition .....	33	
message selector .....	14, 33	
message triggering .....	39	
mobile phone as message receiver.....	48	
modem commands .....	26	
modem connection (commissioning).....	33	
modem connection in plant operation .....	68	
modem entries (fundamentals).....	26	
modem reset button .....	14	
<b>N</b>		
not checked .....	32, 65	
not present .....	32	
null modem.....	12	
number of alarms delivered.....	70	
number of devices .....	28	
<b>O</b>		
opening a connection .....	25	
operating elements.....	14	
operating level .....	15	
operation LED .....	15	
order of SMS messages.....	69	
<b>P</b>		
pager .....	51	
pager as message receiver .....	35, 51	
parameter set .....	43	
		plant name.....
		plant operating software .....
		plant operation.....
		plant operation with ACS7.....
		present.....
		process image .....
		product documentation .....
		production number.....
		programming LED .....
		protocol = GSM.....
		provider number .....
		<b>Q</b>
		quick onsite checks .....
		<b>R</b>
		range .....
		receiver type ACS.....
		receiver type e-mail .....
		receiver type fax .....
		receiver type pager.....
		receiver type SMS .....
		remote setting clock slave .....
		removing devices.....
		replacement of central communication unit.....
		representation of fault status messages .....
		reset command.....
		RS-232 port .....
		RS-232 selector .....
		<b>S</b>
		selecting the language.....
		serial number.....
		service interface .....
		service level.....
		signal time system report.....
		SIM card .....
		slave .....
		slave (clock).....
		slave (system time fault).....
		SMS.....
		SMS as message receiver.....
		software version .....
		standard null modem .....
		starting the ACS .....
		state fault inputs .....
		storing fault status messages .....
		substitution of characters in text messages.....
		summer time start.....
		supply state .....
		switching power off.....
		system report.....
		system report as e-mail .....



system report to fax .....	58
system report to mobile phone.....	56
system report to pager .....	57
system time fault .....	61

**T**

TAP message receiver.....	34
TAP protocol .....	13, 22, 35, 37
telephone provider number .....	35
third-party devices.....	18
time of day .....	61
topology .....	7
turning power on .....	74
type of central communication unit .....	22

type of modem .....	25
---------------------	----

**U**

UCP message receiver .....	34
UCP protocol .....	13, 22, 35, 37
update device information .....	28
USB .....	20
USB interface .....	11
user-defined text .....	23, 42

**W**

winter time start.....	61
wiring test .....	40, 44



# Revision history

The following changes have been made against edition 1.0:

Section/ subsection	Change
1.4.1	2 types of products added
1.4.2	Operating Instructions "Alarm software" U5641 added
2.3	4 screenshots replaced
4.1.4	2 screenshots relocated, previous step 8 removed
4.2	New procedure if both code numbers do not agree
4.3.1	Paragraph "Datapoints": "... searches for the next free device address ..."
4.3.3	Datapoint "Baud rate RS-232": Default setting is 9.6 kBd
4.3.4	Initialization command corrected: ...&D2S0=2
4.4.2	Datapoint "Generating the device list": " • The central communication unit ..." added Datapoint "Generating the device list": Sentence "During the time ..." added Datapoint "Update device information": Sentence "During the time ..." added Datapoint "Device 1", etc.: Sentence "If a device is set to Inactive ..." added
4.4.2	Paragraph "Triggering the device search run": Sentence "The datapoint ..." deleted
4.4.3	Several sentences removed Indication of path with datapoint "Update device information" removed
4.4.4	Paragraph "Adding a device": "effectively" replaced by "completely"
4.4.5	Datapoint "Device state": Text changed
4.4.5	Paragraph "Device list state": 1 line in table deleted
4.5.3	Table "Communication protocol" = TAP: At item 8 note (as supplied) deleted
4.6.1	Datapoint "Message receiver": No messages are delivered ...
4.7	Datapoint "Message cycle": Last sentence changed
4.7	Cross reference to subsection 6.3.5 now more precise
4.9	New paragraph
5.1	Step 3 corrected
6.2.1	ACS in place of ACS7
6.3.7	Examples for making contact changed
6.4.1	Screenshot moved from step 6 to step 5 Screenshot moved from step 7 to step 6 Step 7: Text added Step 8: Text deleted
6.7.1	New paragraph "Faults of fault inputs", taken from table in subsection 6.7.2
6.7.2	Sentence "If there are several ....": All faults are delivered
6.7.2	Paragraph "Special handling" added
6.7.3	• Network address in place of • Device address Sentence "If the fault status message ..." added
6.7.4	Paragraph "Device list state" added" (taken from subsection 4.4.5)
6.7.4	Paragraph "Available choices": Action 1: Text changed Both footnotes corrected
6.7.5	Paragraph "Fault on Konnex bus" added
6.9.2	Datapoints "Area", "Line" and "Device address": New text: "... can assume values ..."

Siemens Switzerland Ltd  
Building Technologies Group  
International Headquarters  
HVAC Products  
Gubelstrasse 22  
CH -6301 Zug  
Tel. +41 41 724 724 24 24  
Fax +41 41 724 724 35 22  
[www.sbt.siemens.com](http://www.sbt.siemens.com)

© 2004 Siemens Switzerland Ltd  
Subject to alteration

76/76