

9222P01

DESIGO™ PX

Automation stations modular series

PXC....D
PXC...-E.D
PXA40-...

- Freely programmable modular automation stations for HVAC and building services plants.
- Native BACnet automation station with communications BACnet via LonTalk, PTP or Ethernet / IP
- BTL label (BACnet communications is BTL tested)
- High performance and reliable operation
- Comprehensive management and system functions (alarm management, time schedules, trends, remote management, access protection, etc.)
- The integrated web server allows for generic or graphical web operation as well as sending alarms via SMS or email
- Island bus to connect external TX-I/O modules with any data point mix
- For stand-alone applications, or for use within a device or system network
- Supports the following operating elements:
 - local / network capable operator units PXM...
 - PX-WEB (operation via web browser, touch panel or PDA)
- System controller for integration of DESIGO RXC and LONMARK® compatible 3rd party devices

Type summary

Automation stations

for connection of TX-I/O-modules via island bus

	Up to 200 data points	Over 200 data points
Automation station BACnet / LonTalk	PXC100.D	PXC200.D
Automation station BACnet / IP	PXC100-E.D	PXC200-E.D

Compatibility

Operating units	Type	Data sheet
Local operating unit	PXM10	CM1N9230
Operating unit	PXM20	CA1N9231
Operating unit for Ethernet	PXM20-E	CM1N9234
Connection cable (to connect to operator units PXM10 or PXM20 and to download firmware)	PXA-C1	--

TX-I/O device	Type	Data sheet
Digital input module 8 or 16 I/O points	TXM1.8D, TXM1.16D	CM2N8172
Universal module without / with local operation and LCD	TXM1.8U, TXM1.8U-ML	CM2N8173
Super universal mod. without / with local operation and LCD	TXM1.8X, TXM1.8X-ML	CM2N8174
Relay module without / with local operation	TXM1.6R, TXM1.6R-M	CM2N8175
Resistance measuring module (for Pt100 4-wire)	TXM1.8P	CM2N8176
Power supply module 1.2 A, Fused 10A	TXS1.12F10	CM2N8183
Bus interface module, Fused 10A	TXS1.EF10	CM2N8183
Island bus expansion module	TXA1.IBE	CM2N8184
TX OPEN module	TXI1.OPEN	CM1N8185

System controllers

for integration via extension modules PXX...

System controller BACnet / LonTalk	PXC00.D
System controller BACnet / IP	PXC00-E.D

Extension module LonWORKS

for integration of DESIGO RXC and LonMark compatible 3rd party devices (together with PXC00....D)

	Type	Data sheet
Integration of max. 60 devices	PXX-L11	CM1N9282
Integration of max. 120 devices	PXX-L12	

Option module for Automation stations and system controllers PXC00 / 100 / 200.D (BACnet/LonTalk)

The option module can be mounted in place of the front cover.

Module PXA40-...	T
Interfaces	
USB Host (for modem via PXA-C3)	X
Network functions	
PTP Dial-in XWP (modem) ¹⁾	X

Option module for Automation stations and system controllers PXC00 / 100 / 200-E.D (BACnet/IP)

The option module can be mounted in place of the front cover.

Module PXA40-...	W0	W1	W2	T
Interfaces				
Ethernet RJ45	X	X	X	
USB Host (für Modem via PXA-C3)	X	X	X	X
Remote management				
PTP Dial-in DESIGO INSIGHT (Modem) ¹⁾	X	X	X	X
PPP via Ethernet RJ45 ¹⁾	X	X	X	
Web functions				
Generic Web functions	X ²⁾	X	X	
Graphic Web functions	X ²⁾		X	
Send alarms via SMS (Modem)	X	X	X	
Send alarms via E-Mail (RJ45)	X	X	X	

¹⁾ The modem connection can be configured as follows:

- either for Remote Management (XWP)
- or for Remote Management PX WEB generic / graphical and alarming with SMS.

²⁾ Web functions for the own automation station only

Option modules are "hot-pluggable"

PXA40-... option modules can be plugged and unplugged when the automation station is operating.

- The functionality is available immediately after inserting.
- The functionality disappears approx. 1 minute after unplugging.

Automation station functions

These freely programmable automation stations provide the infrastructure for the provision and processing of system-specific and application-specific functions. In addition to the control functions, the automation station also incorporates convenient integrated management functions such as:

- Alarm management with alarm routing throughout the network. Management of simple, basic and extended alarms, with safe transfer tracking and automatic monitoring of alarm transmission
- Time schedules
- Trend
- Remote management function
- Access protection throughout the network, with individually definable user profiles and categories

Programming language

The automation stations are freely programmable in D-MAP programming language. This involves the creation of plant operating programs through graphics-based interconnection of function blocks and compounds held in libraries.

Communication

BACnet/IP
(PXC...-E.D only)

Communication is via Ethernet with the internationally standardized BACnet protocol. Both peer-to-peer communications with other automation stations and connection to the PXM20-E operator units are supported.

BACnet/LonTalk
(PXC....D only)

The devices communicate via an open LonTalk system in accordance with the international standard BACnet protocol. Both peer-to-peer communications with other automation stations and connections to the PXM20 operator units are supported.

BACnet/PTP
(with option
module
PXA40...)

The devices communicate via the public telephone network in accordance with the international standard BACnet protocol.

Automation station operation

There are various options for the operation of the PXC...U automation stations:

- **Local PXM10 operator unit**, connected via a PXA-C1 cable
- **Network-compatible PXM20 operator unit** (BACnet/LonTalk) for operation of the local automation station or an automation station in a network,; connected via PXA-C1 cable
- **Network capable operator unit PXM20-E** (BACnet / IP) to operate an automation station in the network, connected to an Ethernet hub or switch
- **PX-WEB**: Optional web server via PXA40-W... option module. Allows operation with a web browser, a touch panel or a PDA. The transfer of alarms via SMS or e-mail can be configured in the automation station.

The compact construction enables the automation stations to be mounted on a standard mounting rail.

PXC...D

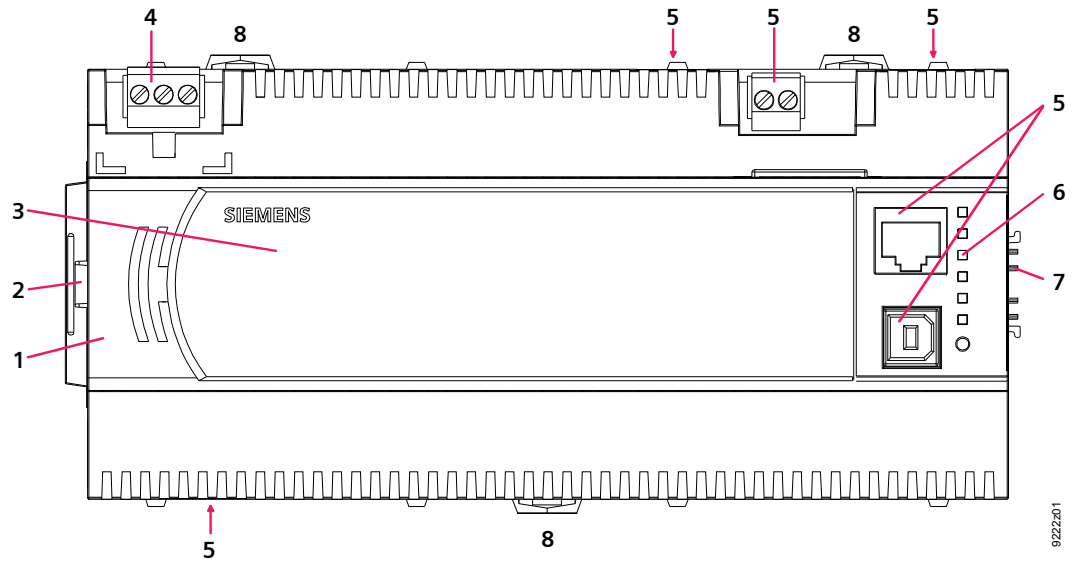

PXA40-...

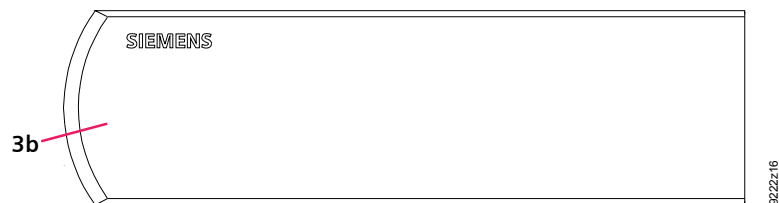

1	Plastic housing
2	Cover to interface for extension module
3a	Front cover
3b	PXM40-... option module
4	Plug-in terminal block with screw terminals (operating voltage)
5	Interface for network, operator units, tool, etc.
6	LED display for devices and system status
7	Island bus connector (not on PXC00...)
8	Slider for mounting on DIN rail

LED indicators

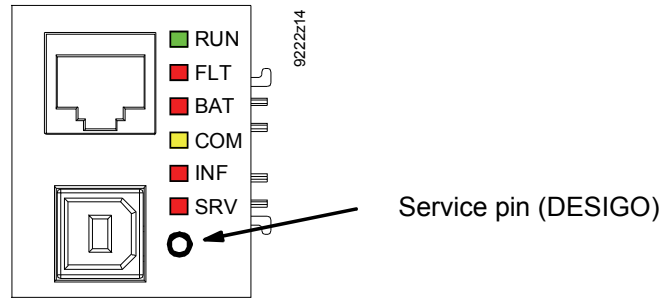

LED	Color	Activity	Function
RUN	Green	Continuously ON Continuously OFF	Power OK No power
FLT	Red	Continuously OFF Continuously ON Rapid flashing	OK Fault Firmware missing / corrupt
BAT	Red	Continuously OFF Continuously ON	Battery OK Battery empty– replace!
COM	Yellow	Continuously ON Continuously OFF Flashing	Connection to hub OK No connection to hub Communication
INF	Red		Freely programmable
SRV (Ethernet)	Red	Continuously OFF Continuously ON Flashing Flashing per wink command *)	OK No connection to hub No IP address configured Physical identification of automation station after receipt of wink command
SRV (LONWORKS Bus)	Red	Continuously OFF Continuously ON Flashing Flashing per wink command *)	LONWORKS node is configured Faulty LONWORKS chip, or service pin currently depressed LONWORKS node is not configured Physical identification of automation station after receipt of wink command

*) Wink command pattern:

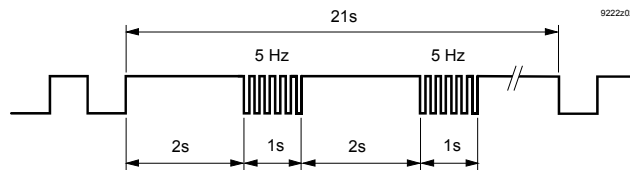

Mounting instructions

The automation stations can be snapped onto standardized rails.

The power supply connection and the room devices have plug-in screw terminal blocks. The other interfaces are quick plug-in connections.

Instead of the front cover a PXA40... option module can be fitted on the modular automation station.

Commissioning

In order to prevent equipment damage and/or personal injuries always follow local safety regulations and the required safety standards.

Load plant operating program

The plant operating program is downloaded using the CFC from XWP – locally via the automation station's RJ45 interface or via the network (BACnet/IP or BACnet/LonTalk).

Setting parameters and configurations

Use the PX Design tool in XWP for setting the control parameters and the configuration data. Data visible on the network may also be edited with an operator unit PXM20 / PXM20-E (BACnet / LonTalk or BACnet / IP). Part of the data can also be edited locally using the operator unit PXM10.

Wiring test

It is possible to test field devices and the wiring as soon as the power supply is connected, without first downloading the plant operating program.

- BACnet / LonTalk for PXC...D and PXC...T.D: using operator unit PXM20
- BACnet / IP for PXC...E.D: using operator unit PXM20-E.

Requirement: PX and PXM20-E are on the default IP and alone on the IP segment.

Network connection

The network addresses are configured with XWP. For unique identification in the network (BACnet/IP or BACnet/LonTalk), press the **Service button with a long, pointed object** or send a wink command to the appropriate automation station (service LED blinks).

Force Firmware Download

• Variant via V24:

If the **Force Firmware Download Key** is pressed during a restart (reset), the current D-MAP program is deleted from the FLASH.

The automation station waits briefly for the signal to activate the FWLoader and then starts the automation station.

• IP variant: (for PXC...E.D, significantly faster)

Press the **Force Firmware Download Button** for 5 seconds (without hitting the reset button).

Requirement: The automation station has conducted a node setup and no application is loaded or was deleted in the CFC by clear/reset (communication settings remain – which would not be the case when erasing by pressing the reset key).

Restart

Press the **Reset button** to force a restart

Assignment of buttons and batteries

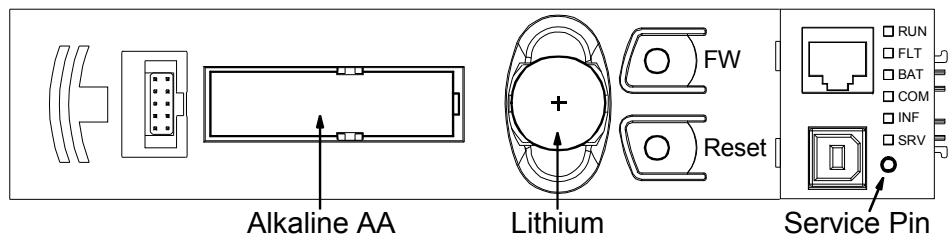

Power supply

The power supply of the automation station must be switched on and off simultaneously with the power supply of the TX-I/O modules. Otherwise, unwanted alarms will be generated.

Battery life

Database information is stored in **SDRAM** which is supported by a battery (**Alkaline AA**). This saves time for reloading the program and database after longer power outages (up to approx. 1 month). Alkaline batteries usually have a life span of at least four years. After the “Battery low” event, the battery still has a residual life of a few more days.

The **Real-Time Clock** is supported by a **lithium battery** with a life span of at least 10 years.

The Low BAT LED lights up when one of the batteries charges is low and the automation station automatically sends a system event. It can also be set as an alarm to selected recipients.

Replacing the battery

To change the battery remove the front cover. The battery can be removed indefinitely as long as the unit has power.



Caution

A wrist-strap and grounding cable must be used to avoid hardware damage through electrostatic discharge (ESD).

Firmware upgrades

Firmware and operating system stored in non-volatile Flash ROM. Flash ROM memory can be easily updated on the plant, when a new firmware version is available.

Disposal



The devices are classified as waste electronic equipment in terms of the European Directive 2002/96/EC (WEEE) and should not be disposed of as unsorted municipal waste.

The relevant national legal rules are to be adhered to.

Regarding disposal, use the systems setup for collecting electronic waste. Observe all local and applicable laws.

Technical data

General device data	Operating voltage	AC 24 V ± 20%	
	Safety extra-low voltage SELV or Extra-low voltage PELV	HD 384	
	Operating frequency	50/60 Hz	
	Energy consumption	Max. 24 VA (same for all types)	
	Internal fuse	5 A	
Operating data	Processor	Motorola Power PC MPC885	
	Storage	64MB SDRAM / 32MB FLASH (96MB total)	
	Accuracy class	0.5	
	Data backup in event of power failure		
	Battery backup for SDRAM	Typically one month (unused: 4 years)	
	1 x AA alkaline (replaced on plant)		
	Battery backup for real-time clock	10 years	
	Lithium (replaced on plant)		
Communication interfaces	PXC....D	PXC...-E.D	
	Building Level Network	LONWORKS FTT Transceiver (screw terminals (B))	10 Base-T / 100 Base-TX IEEE802.3, Auto-sensing (RJ45 (D))
	Local communication (HMI) (RJ45 (C))	<ul style="list-style-type: none"> • PXM20 (BACnet/LonTalk) *) 	
	Local communication (HMI, Tool) (RJ45 (E))	<ul style="list-style-type: none"> • PXM10 (serial) • PXM20 (BACnet/LonTalk) *) • Tool Connection cable max. 3 meters	
	Local communication (HMI) (RJ45 (G))	<ul style="list-style-type: none"> • PXM10 (serial) 	<ul style="list-style-type: none"> • PXM10 (serial)
	USB host interface (Modem)	<ul style="list-style-type: none"> • RS232 modem (via USB-RS232 adapter cable PXA-C3) (for future applications)	<ul style="list-style-type: none"> • RS232 modem (via USB-RS232 adapter cable PXA-C3) (for future applications)
	USB device interface	(for future applications)	(for future applications)
Ethernet interface	Interface type	100BaseTX, IEEE 802.3 compatible	
	Bit rate	10 / 100 MBit/s, autosensing	
	Protocol	BACnet on UDP/IP	
	Pin	RJ45 socket, screened	
LONWORKS bus interface	Network	TP/FT-10	
	Baud rate	78 kBit/s	
	Protocol	BACnet	
	Interface chip	Echelon Processor TMPN3150B1AF	
Island bus interface (CD, CS)	Short-circuit proof	Short-circuit proof	

*) only ONE PXM20 per automation station

Plug-in screw terminal	Power supply	Solid or stranded conductors 0.25...2.5 mm ² or 2 x 1.5 mm ²	
Plug-in screw terminal	LonWorks bus	Solid or stranded conductors 0.25...2.5 mm ² or 2 x 1.5 mm ²	
Simple cable lengths, cable types (see Installation Guide PX, CA110396)	Connection cable Ethernet and PXM20-E Cable type	Max. 100 m Standard at least CAT5 UTP (Unshielded Twisted Pair) or STP (Shielded Twisted Pair) See Installation Guide CA110396	
	Connection cable LonWORKS bus Cable type	See Installation Guide CA110396 ConCab or CAT5	
Connection cables for island bus	Connection cable PXM10 bus	Max. 3 m See CM110562	
Housing protection standard Protection class	Protection standard to EN 60529 Insulation protection class	IP 20 II	
Ambient conditions	Normal operation	To IEC 69721-3-3	
	Environmental conditions	Class 3K5	
	Temperature	0...50 °C	
	Humidity	5...95 % r.h. (non-condensing)	
	Mechanical conditions	Class 3M2	
	Transport	To IEC 69721-3-2	
	Environmental conditions	Class 2K3	
	Temperature	-25...70 °C	
	Humidity	5...95 % r.h. (non-condensing)	
	Mechanical conditions	Class 2M2	
Standards, guidelines And approvals	Product safety		
	Automatic electronic controls for household and similar use	EN 60730-1	
	Electromagnetic compatibility		
	Interference immunity	EN 61000-6-2 (industry)	
	Emitted interference	EN 61000-6-3 (residential)	
	CE compliance:		
	Electromagnetic compatibility	2004/108/EC	
	UL approval (UL 916)	PAZX7	
	Federal Communications Commission (US)	FCC CFR 47 Part 15 Class B	
	C-Tick compliance per Australian EMC Framework Radio Emission Standard	Radio Communications Act 1992 AS/NZS 2064	
Environmental compatibility	The product environmental declaration CM1E9222 contains data on environmentally compatible product design and assessments (RoHS compliance, materials composition, packaging, environmental benefit, disposal)	ISO 14001 (Environment) ISO 9001 (Quality) SN 36350 (Environmentally compatible products) 2002/95/EC (RoHS)	
Dimensions	See "Dimensions"		
Weight		<i>Excluding packaging</i>	<i>With packaging</i>
	All types	0,489 kg	0,531 kg

PXC...D

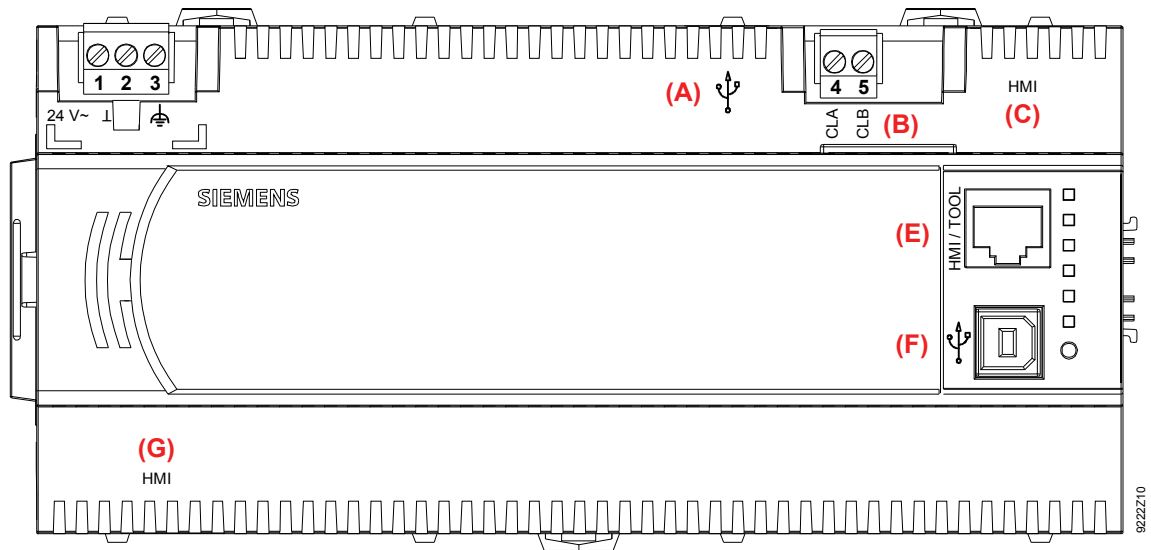

9222Z10

PXC...-E.D

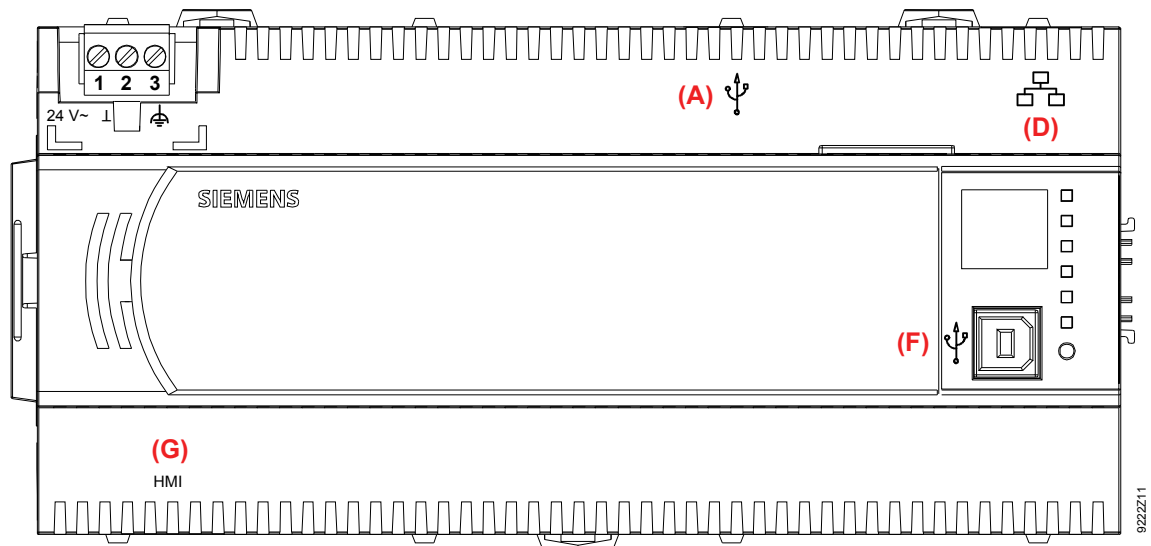

9222Z11

1, 2	24 V ~, ⊥	Operating voltage AC 24 V	Plug-in screw terminal block
3	⏏	Functional ground	
(A)	🔌	USB host interface (for modem via PXA-C3 adapter cable)	
4,5 (B)	CLA, CLB	LONWORKS bus	Plug-in screw terminal blocks
(C)	HMI	RJ45 interface (LONWORKS) for operator unit PXM20 (tool as well)	
(D)	🌐	RJ45 interface for Ethernet (Operator unit PXM20-E can be connected to hub/switch)	
(E)	HMI / Tool	RJ45 interface (LONWORKS and serial) for PXM10, PXM20 and tool	
(F)	🔌	USB device interface (for future applications)	
(G)	HMI	RJ45 interface (serial) for operator unit PXM10	

Pin assignment for RJ45 plug

Plug (C) "HMI" (LONWORKS)

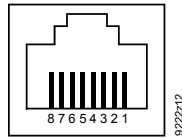

Pin	description	Pin	description
1.	LONWORKS Data A (CLA)	5.	Unused
2.	LONWORKS Data B (CLB)	6.	Unused
3.	G0 / GND	7.	Unused
4.	G / Plus	8.	Unused

Plug (D) Ethernet

RJ45 socket screened, standard connection in accordance with AT&T256

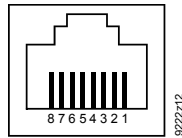

1.	Tx+	5.	Unused
2.	Tx -	6.	Rx -
3.	Rx +	7.	Unused
4.	Unused	8.	Unused

Plug (E) "HMI / Tool" (LONWORKS and serial)

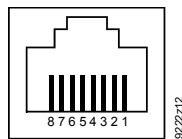

1.	LONWORKS Data A (CLA)	5.	Unused
2.	LONWORKS Data B (CLB)	6.	Unused
3.	GND	7.	COM1 / TxD
4.	+24 V max. 300 mA (PXM20)	8.	COM1 / RxD

Plug (G) "HMI" (serial)

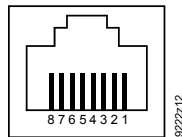

1.	unused	5.	Unused
2.	unused	6.	*)
3.	G0 / GND	7.	COM1/TxD
4.	G / Plus	8.	COM1/RxD

*) 6 Unused (PXC....D)
Connected to pin 8 (PXC...-E.D)

Connection diagrams

Connecting TX-I/O modules and field devices

See Planning and Installation Guide TX-I/O, CM110562.

Dimensions

All dimensions in mm

Automation stations, system controllers PXC...D

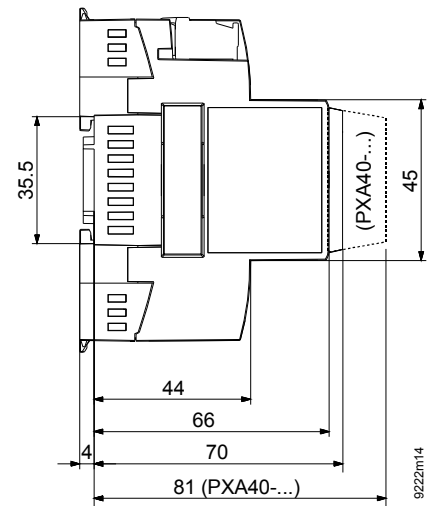
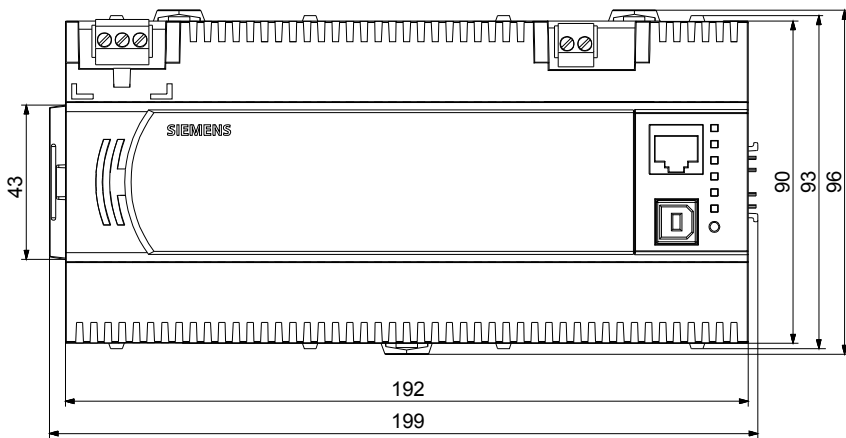
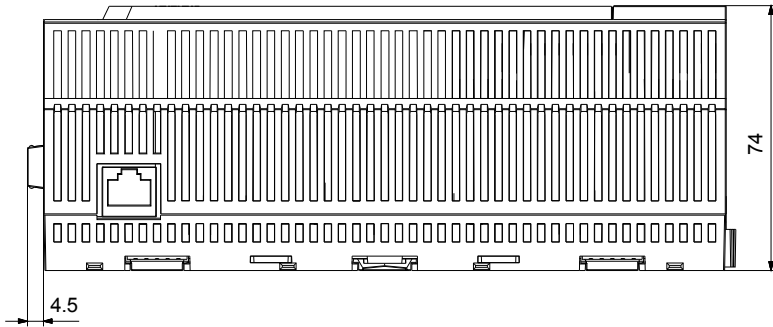

Option modules PXA40-...

