



ACVATIX™

## Electromotoric actuators for **SAX..P..** valves

with a 20 mm stroke

- 
- **SAX31P03** Operating voltage AC 230 V, 3-position control signal
  - **SAX61P03** Operating voltage AC/DC 24 V, control signal DC 0...10 V, 4...20 mA
  - **SAX81P03** Operating voltage AC/DC 24 V, 3-position control signal
  - **SAX61P03** Position feedback, override control, choice of flow characteristic
  - For direct mounting on valves; no adjustments required
  - Manual adjuster, position indicator and status indication per LED
  - Optional functions with auxiliary switches, potentiometer, function module, stem heating element

### Use

---

Electromotoric actuators for the operation of Siemens combi valves of types VPF43.. and VPF53.. with 20 mm stroke as control and safety shut-off valves in ventilation, air conditioning, district heating and refrigerating systems.

## Type summary

Product no.	Stock no.	Stroke	Pos. force	Operating voltage	Positioning signal	Spr. ret. time	Pos. time	LED	Manual adjuster	Extra functions
SAX31P03	S55150-A118	20 mm	500 N	AC 230 V	3-position	-	30 s	-	Push and fix	1)
SAX61P03	S55150-A114			AC/DC 24 V	DC 0...10 V DC 4...20 mA 0...1000 Ω			✓		2), 3)
SAX81P03	S55150-A116			3-position	-			1)		

1) Optional accessories: auxiliary switch, potentiometer

2) Position feedback, forced control, change of characteristic

3) Optional accessories: auxiliary switch, sequence control, selection of acting direction

## Electrical accessories

Product no.	Auxiliary switch ASC10.51	Potentiometer ASZ7.5/.. <sup>1)</sup>
Stock no.	S55845-Z103	S55845-Z104 (ASZ7.5/135) S55845-Z105 (ASZ7.5/200) S55845-Z106 (ASZ7.5/1000)
	Max. 2	
SAX31P..	Max. 2	Max. 1
SAX61P..	Max. 2	-
SAX81P..		Max. 1

<sup>1)</sup> Available with 135 Ω, 200 Ω or 1000 Ω

## Mechanical Accessory Weather shield ASK39.1

## Ordering



### Example

Product no.	Stock no.	Description	Quantity
SAX81P03	S55150-A116	Actuator	1
ASZ7.5/1000	S55845-Z106	Potentiometer	1

### Delivery

Actuators, valves and accessories are supplied in individual packs.

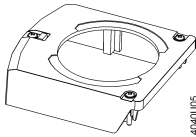
### Spare parts

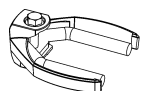
Product number / Stock number	Description	Image
8000060843	Housing cover	
	Screw (valve stem coupling)	
	U-bracket	

## Combinations

VPF43..	Type	Stock no.	DN	H <sub>100</sub> [mm]	$\dot{V}_{min}$ [m <sup>3</sup> /h]	$\dot{V}_{100}$ [m <sup>3</sup> /h]	$\Delta p_{min}$ [kPa]	Data sheet
Standard flow	VPF43.50F16	S55266-V100	50	20	2.3	15	35	N4315
	VPF43.65F24	S55266-V102	65		4.4	25		
	VPF43.80F35	S55266-V104	80		5.3	34		
High flow	VPF43.50F25	S55266-V101	50	20	4.3	25	70	
	VPF43.65F35	S55266-V103	65		6	35		
	VPF43.80F45	S55266-V105	80		7	43		

VPF53..	Type	Stock no.	DN	H <sub>100</sub> [mm]	$\dot{V}_{min}$ [m <sup>3</sup> /h]	$\dot{V}_{100}$ [m <sup>3</sup> /h]	$\Delta p_{min}$ [kPa]	Data sheet
Standard flow	VPF53.50F16	S55266-V112	50	20	2.3	15	35	N4316
	VPF53.65F24	S55266-V114	65		4.4	25		
	VPF53.80F35	S55266-V116	80		5.3	34		
High flow	VPF53.50F25	S55266-V113	50	20	4.3	25	70	
	VPF53.65F35	S55266-V115	65		6	35		
	VPF53.80F45	S55266-V117	80		7	43		

## Product documentation

Detailed Informations about the New Generation actuators can be found in the Basic documentation for actuators (P4040).

## Notes

### Engineering

SAX31P03 and  
SAX81P03

3-position actuators must have their own specific controller, refer to "Connection Diagrams" (page 8).

SAX61P03

Up to 10 actuators can drive in parallel on a controller output with a rating of 1 mA. Modulating actuators have an input impedance of 100 k $\Omega$ .

### Mounting

Mounting positions

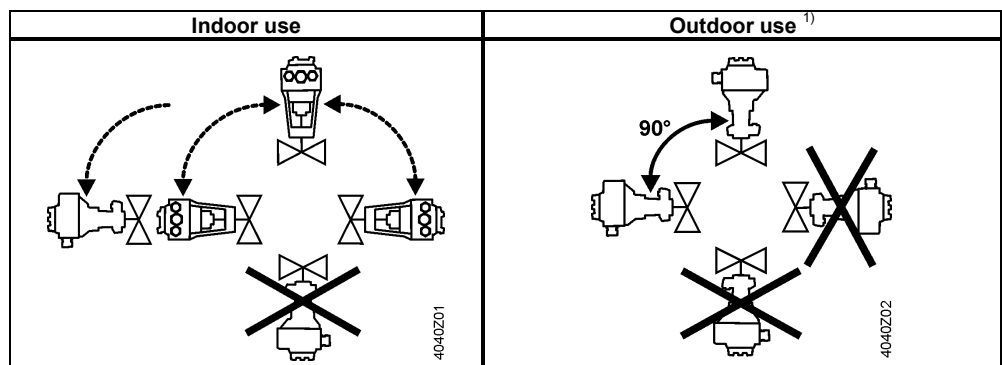

<sup>1)</sup> Only in connection with weather shield ASK39.1

### Acting direction

With valves whose stem is retracted in the fully closed position, "direct acting" means that the valve is fully closed (100 %) when positioning signal Y = 0 V and Z = 0  $\Omega$  respectively.

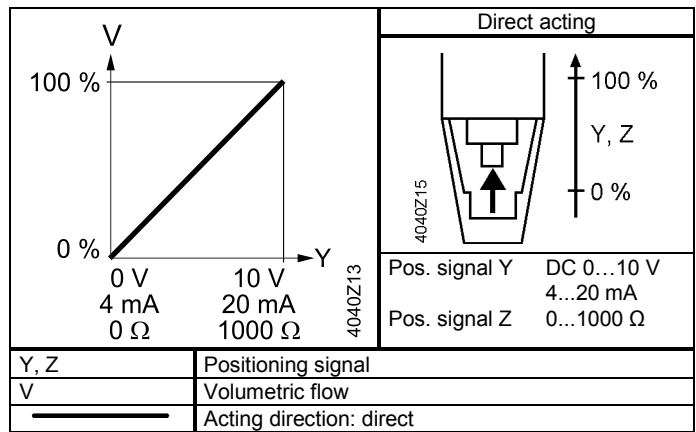

**Maintenance**

The actuators are maintenance-free.

**Warranty**

The engineering data specified in chapter "Combinations" (page 3) are only guaranteed in connection with the Siemens valves listed.

**Note**

**When using the actuators in connection with valves of other manufacture, correct functioning must be ensured by the user, and Siemens will assume no responsibility.**

## Technical Data

		SAX..P
<b>Power supply</b>	Operating voltage SAX31P03 SAX61P03 SAX81P03	AC 230 V ±15% AC 24 V ± 20% / DC 24 V + 20% / -15% AC 24 V ±20% / DC 24 V + 20 % / -15%
	Frequency	45...65Hz
	Fusing ac. DIN 57100 part 430 (supply lines)	6 A...10 A slow
	Power consumption at 50 Hz	
	SAX31P03 Stem retracts / extends SAX61P03 Stem retracts / extends SAX81P03 Stem retracts / extends	6 VA / 3.5 W 8 VA / 3.75 W 5 VA / 3.75 W
<b>Function data</b>	Positioning times (with the specified nominal stroke) The positioning time can vary, depending on the type of valve -> refer chapter "Type summary" (page 2) SAX31P03, SAX61P03, SAX81P03	30 s
	Positioning force Nominal stroke Permissible medium temperature (valve fitted)	500 N 20 mm 1...130 °C
<b>Signal inputs</b>	Positioning signal "Y" SAX31P03, SAX81P03 SAX31P.. Voltage SAX81P.. Voltage SAX61P03 (DC 0...10 V) Current draw Input impedance SAX61P03 (DC 4...20 mA) Current draw Input impedance	3-position AC 230 V ±15% AC 24 V ± 20 % / DC 24 V + 20 % / -15% ≤ 0.1 mA ≥ 100 kΩ DC 4...20 mA ± 1% ≤ 500 Ω
	<b>Parallel operation</b> SAX61P03	≤ 10 (depending on controller output)
<b>Forced control</b>	Positioning signal "Z" SAX61P03 R = 0...1000 Ω Z connected to G Z connected to G0 Voltage Current draw	R = 0...1000 Ω, G, G0 Stroke proportional to R Max. stroke 100% <sup>1)</sup> Min. stroke 0% <sup>1)</sup> Max. AC 24 V ± 20% Max. DC 24 V + 20% / -15% ≤ 0.1 mA
<b>Position feedback</b>	Position feedback U SAX61P03 Load impedance Load	DC 0...10 V ± 1% > 10 kΩ res. Max. 1 mA
<b>Connecting cable</b>	Wire cross-sectional areas	0.75...1.5 mm <sup>2</sup> , AWG 20...16 <sup>2)</sup>
	Cable entries SAX..P..	EU: 2 entries Ø 20.5 mm (for M20) 1 entry Ø 25.5 mm (for M25)
<b>Degree of protection</b>	Housing from vertical to horizontal	IP54 as per EN 60529 <sup>3)</sup>
	Insulation class	As per EN 60730
	Actuators SAX31P03Y AC 230 V Actuators SAX61P03Y AC / DC 24 V Actuators SAX81P03Y AC / DC 24 V	II III III
<b>Environmental conditions</b>	Operation Climatic conditions Mounting location Temperature General Humidity (noncondensing)	IEC 60721-3-3 Class 3K5 Indoors (weather-protected) 5...55 °C 5...95% r.h.
	Transport Climatic conditions Temperature Humidity	IEC 60721-3-2 Class 2K3 -25...70 °C <95% r.h.
	Storage Climatic conditions Temperature Humidity	IEC 60721-3-1 Class 1K3 -5...55 °C 5...95% r.h.
	Max. media temperature when mounted on valve	130 °C
	<b>Standards</b>	CE conformity As per EMC directive Immunity Emissions Electrical safety Low-voltage directive AC 230 V C-tick UL conformity AC 230 V AC/DC 24 V
<b>Environmental compatibility</b>		ISO 14001 (environment) ISO 9001 (quality) SN 36350 (environment-compatible products) RL 2002/95/EG (RoHS)
<b>Dimensions</b>		See "Dimensions" (page 9)

		SAX..P
Accessories	Potentiometer ASZ7.5/135	0...135 Ω ± 5% Voltage DC 10 V Current rating <4 mA
	Potentiometer ASZ7.5/200	0...200 Ω ± 5% Voltage DC 10 V Current rating <4 mA
	Potentiometer ASZ7.5/1000	0...1000 Ω ± 5% Voltage DC 10 V Current rating <4 mA
	Auxiliary switch ASC10.51	Switching capacity AC 24...230 V, 6 A res., 3 A ind.

- 1) Observe acting direction of DIL switches
- 2) AWG = American wire gauge
- 3) Also with weather shield ASK39.1
- 4) Transformer 160 VA (e.g. Siemens 4AM 3842-4TN00-0EA0) for actuators operating on AC 24 V

## Connection Diagrams

### Internal Diagrams

SAX31P03

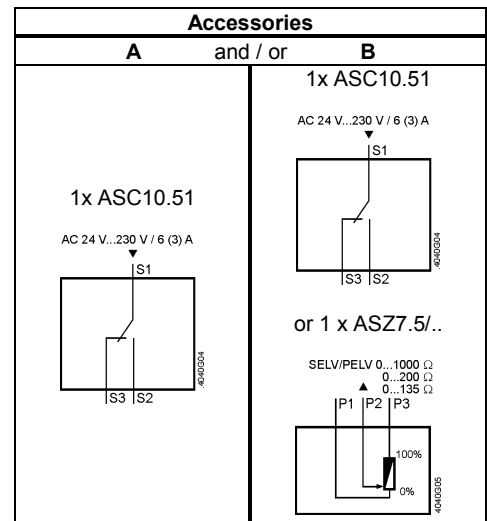
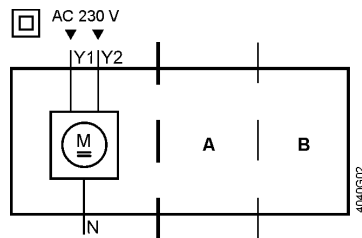

SAX61P03

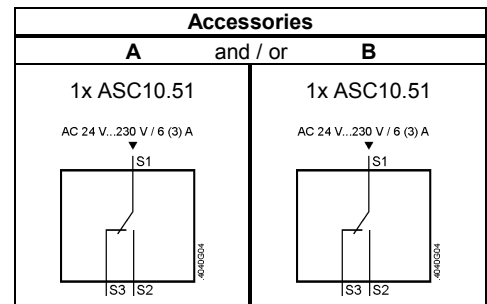
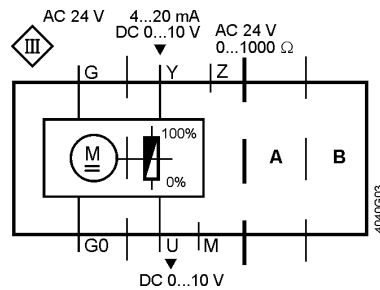

SAX81P03

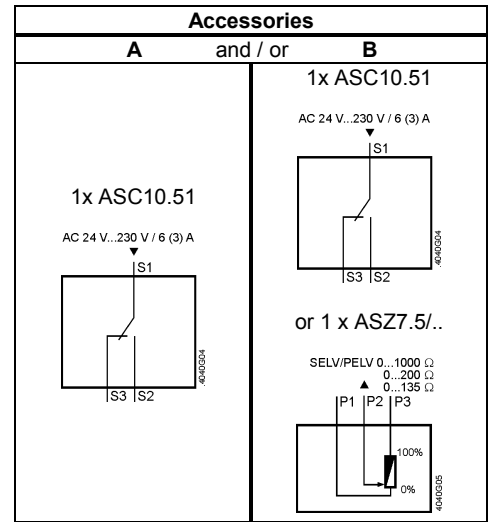
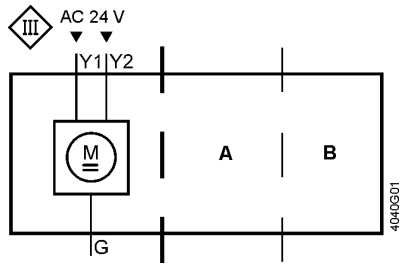

**Connection terminals**

SAX31P03

AC 230 V, 3-position

- N** — System neutral (SN)
- Y1** — Positioning signal (actuator's stem retracts)
- Y2** — Positioning signal (actuator's stem extends)

SAX61P03

AC/DC 24 V, DC 0...10 V / 4...20 mA / 0...1000 Ω

- G0** — System neutral (SN)
- G** — System potential (SP)
- Y** — Positioning signal for DC 0...10 V / 4...20 mA
- M** — Measuring neutral
- U** — Position feedback DC 0...10 V
- Z** — Positioning signal forced control

SAX81P03

AC/DC 24 V, 3-position

- G** — System potential (SP)
- Y1** — Positioning signal (actuator's stem retracts)
- Y2** — Positioning signal (actuator's stem extends)

## Connection Diagrams

### SAX31P03

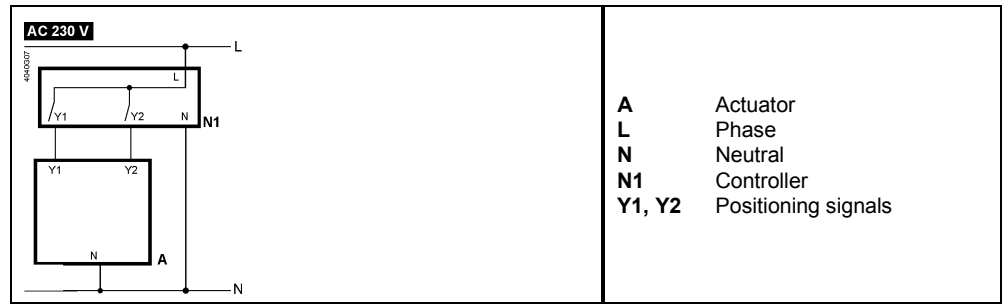

### SAX61P03

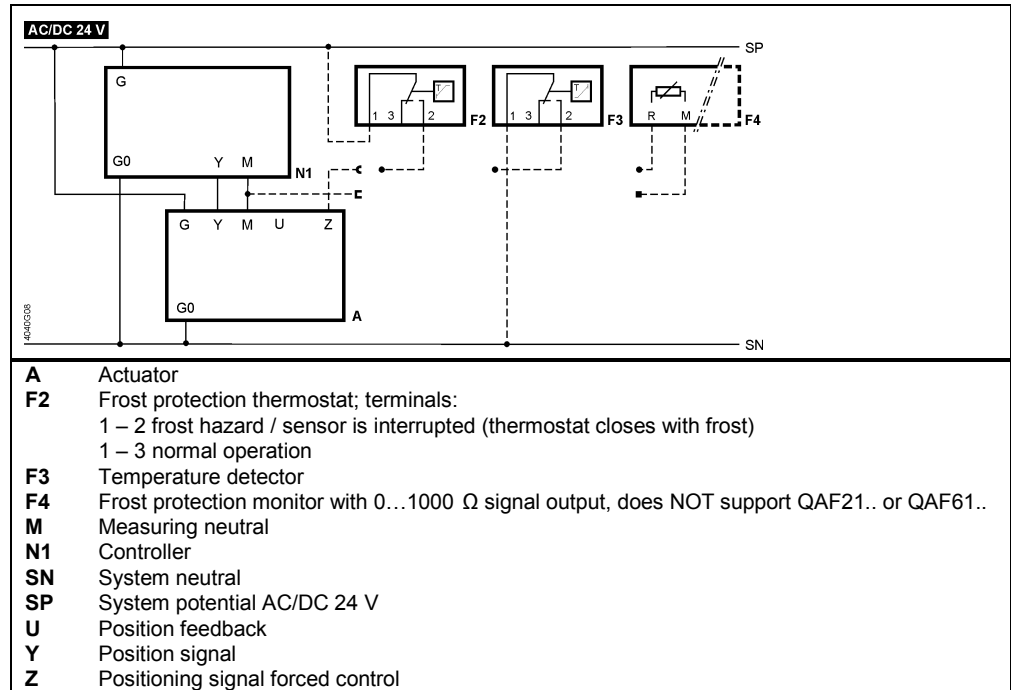

### SAX81P03

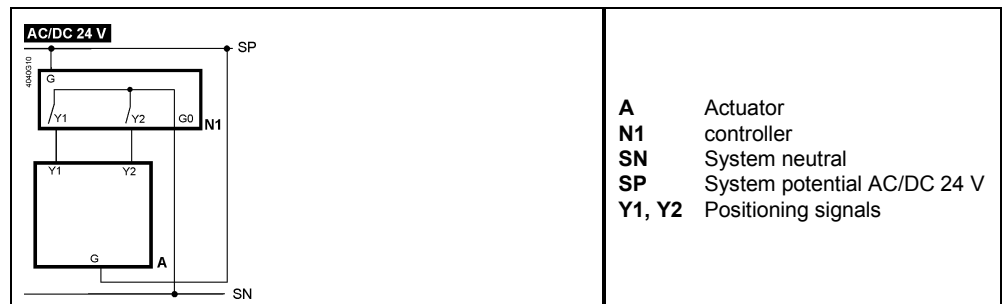



## Dimensions

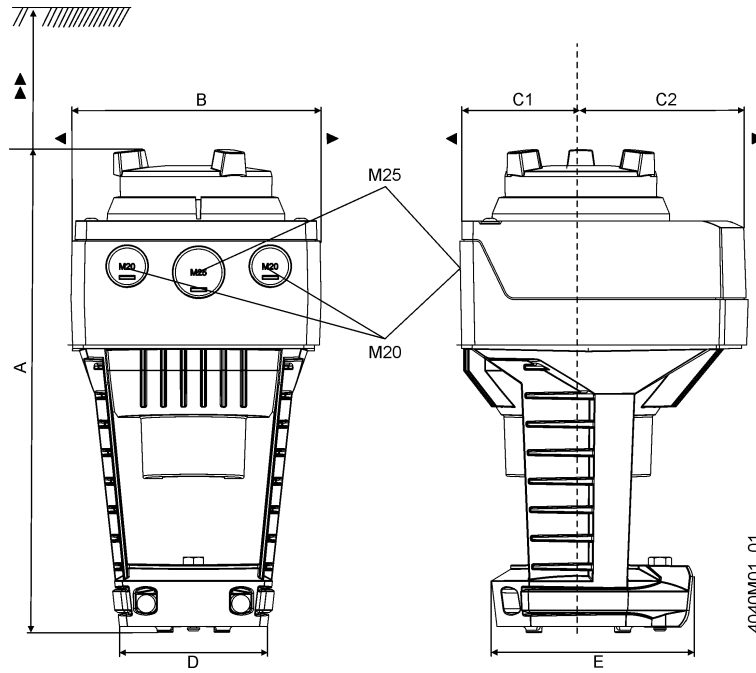

Type	A	B	C	C1	C2	D	E	▶	▶▶	kg
<b>SAX..P..</b>	242	124	150	68	82	80	100	100	200	1,850
<b>With ASK39.1</b>	+25	154	300	200	100	-	-	-	-	2,080

Dimensions in mm

## Revision numbers

Product no.	Valid from rev. no.
<b>SAX31P03</b>	..G
<b>SAX61P03</b>	..G
<b>SAX81P03</b>	..G

